

# L-8

## LiveTrak

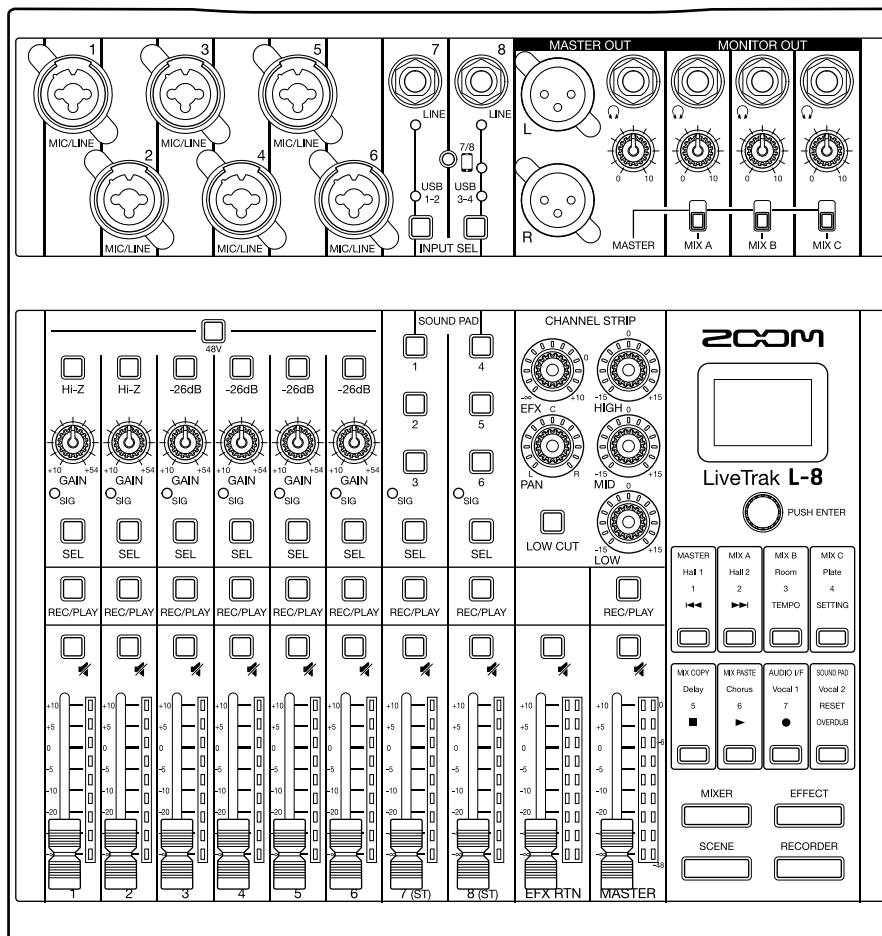

## Operation Manual

You must read the Usage and Safety Precautions before use.

© 2021 ZOOM CORPORATION

Copying or reprinting this manual in part or in whole without permission is prohibited.

Product names, registered trademarks and company names in this document are the property of their respective companies. All trademarks and registered trademarks in this document are for identification purposes only and are not intended to infringe on the copyrights of their respective owners. Proper display is not possible on grayscale devices.

# Operation Manual overview

---

You might need this manual in the future. Always keep it in a place where you can access it easily.

The contents of this document and the specifications of the product could be changed without notice.

© Windows® is a trademark or registered trademark of Microsoft® Corporation.

© Macintosh, macOS, Mac and iPad are trademarks or registered trademarks of Apple Inc.

© iOS is a trademark or registered trademark of Cisco Systems, Inc. in the USA and other countries and is used under license.

© The SD, SDHC and SDXC logos are trademarks.

© Other product names, registered trademarks and company names in this document are the property of their respective companies.

Note: All trademarks and registered trademarks in this document are for identification purposes only and are not intended to infringe on the copyrights of their respective owners.

Recording from copyrighted sources, including CDs, records, tapes, live performances, video works and broadcasts, without permission of the copyright holder for any purpose other than personal use is prohibited by law. Zoom Corporation will not assume any responsibility related to infringements of copyrights.

# Introduction

---

Thank you very much for purchasing a ZOOM LiveTrak **L-8**.

The **L-8** combines a compact digital mixer with a multitrack recorder and a USB audio interface, so it can be used for a variety of applications, including for podcasting and streaming, as a PA for small groups, as a live performance mixer, and for stage performances and music production.

## Main features of the **L-8**

### 8-channel digital mixer & multitrack recorder

---

The compact, lightweight **L-8** combines a digital mixer with 8 input channels, a multitrack recorder capable of recording up to 12 tracks simultaneously, overdubbing and punching in and out, and a 12-in/4-out USB audio interface.

### SOUND PAD function for adding jingles and sound effects when podcasting

---

The **L-8** has SOUND PAD buttons that can be played when podcasting and streaming. Pressing a SOUND PAD plays the jingle or sound effect assigned to it. The SOUND PAD function can also be used during stage performances, for example, to trigger cues.

### Smartphone connection jack

---

The **L-8** has a smartphone connection jack that can be used when podcasting for call-in guests. A mix-minus function is provided to prevent call-in guests from having echoes.

### High-quality mic preamps

---

The **L-8** has high-quality mic preamps built in for 6 channels. The high-quality analog inputs, which can provide +48V phantom power, have EIN of -121 dBu or better and maximum input gain of +54 dB. In addition, channels 1 and 2 also support Hi-Z input, while channels 3 to 6 have PAD functions (26dB attenuation), enabling them to accept +4dBu output.

### 3 monitor output channels

---

In addition to the MASTER OUT, the **L-8** also has 3 MONITOR OUT channels that can be connected to headphones. The MONITOR OUT mixes can be set separately for each output, enabling different mixes to be sent to individual performers.

### Supports AA and mobile batteries

---

The **L-8** can run on AA batteries or a USB mobile battery, allowing it to be used outdoors and in other situations where there is no power supply.

### 12-in/4-out USB audio interface

---

The **L-8** can be used as a 12-in/4-out USB audio interface. The signals from each input and the master fader output can be recorded in a DAW. Moreover, background music can be played from a computer when podcasting by assigning the computer signal to channel 7 or 8.

Class compliant mode, which enables connection with iOS devices, is also supported.

# Contents

---

<b>Operation Manual overview</b> .....	<b>2</b>	<b>Projects</b> .....	<b>66</b>
<b>Introduction</b> .....	<b>3</b>	Changing project names .....	66
<b>Contents</b> .....	<b>4</b>	Deleting projects .....	68
<b>Names and functions of parts</b> .....	<b>5</b>	Protecting projects .....	69
Top .....	5	Checking project information .....	70
Back .....	19	Checking, deleting and moving to marks .....	71
Bottom .....	20	<b>Audio files</b> .....	<b>72</b>
<b>Equipment connection examples</b> .....	<b>21</b>	Deleting audio files .....	72
Podcasting .....	21	Assigning audio files to tracks .....	74
Live PA system .....	22	<b>Audio interface</b> .....	<b>76</b>
<b>Preparations</b> .....	<b>23</b>	Installing the driver .....	76
Providing power .....	23	Connecting to a computer .....	77
<b>Turning the power on and off</b> .....	<b>25</b>	Connecting to an iOS device .....	79
Turning the power on .....	25	Inputting return signals from the computer on channels 7/8 .....	81
Turning the power off .....	26	<b>Card reader</b> .....	<b>82</b>
<b>Using the SETTING screen</b> .....	<b>27</b>	SD card folder structure .....	82
<b>Mixer</b> .....	<b>28</b>	Using card reader functions .....	83
Outputting input sounds from output devices .....	28	<b>Recording and playback settings</b> .....	<b>85</b>
Adjusting the tone and panning .....	30	Changing the recording format .....	85
Using the built-in effects .....	31	Changing automatic recording settings .....	86
Using scene functions .....	33	Showing recording levels on level meters .....	88
Setting signals output from MONITOR OUT A-C ...	36	Compensating for latency during input and output .....	89
Connecting smartphones .....	39	Changing the playback mode .....	90
<b>Recording and playback</b> .....	<b>40</b>	<b>SD card settings</b> .....	<b>91</b>
Preparing to record .....	40	Checking the open space on SD cards .....	91
Recording/overdubbing and playing recordings .....	42	Formatting SD cards .....	92
Adding marks .....	44	Testing SD card performance .....	93
Redoing parts of recordings (punching in/out) .....	45	<b>Making various settings</b> .....	<b>96</b>
Mixing down tracks .....	46	Setting the date and time .....	96
Starting recording automatically .....	48	Changing the sampling rate .....	97
Pre-recording before recording starts .....	50	Disabling the automatic power saving function .....	98
Selecting projects for playback .....	51	Adjusting the display contrast .....	99
<b>SOUND PAD functions</b> .....	<b>52</b>	Setting the display backlight .....	100
Playing sounds with SOUND PAD buttons .....	52	Setting the type of batteries used .....	101
Assigning audio files to SOUND PAD buttons .....	53	Setting the battery saving mode .....	102
Changing SOUND PAD playback methods .....	57	Restoring settings to factory defaults .....	103
Changing SOUND PAD playback levels .....	59	Checking the firmware versions .....	104
<b>Metronome</b> .....	<b>61</b>	Updating the firmware .....	105
Enabling the metronome .....	61	<b>Troubleshooting</b> .....	<b>107</b>
Changing metronome settings .....	62	<b>Specifications</b> .....	<b>110</b>
		<b>Send effect specifications</b> .....	<b>111</b>
		<b>Mixer block diagram</b> .....	<b>112</b>

# Names and functions of parts

## Top

### Input channel section

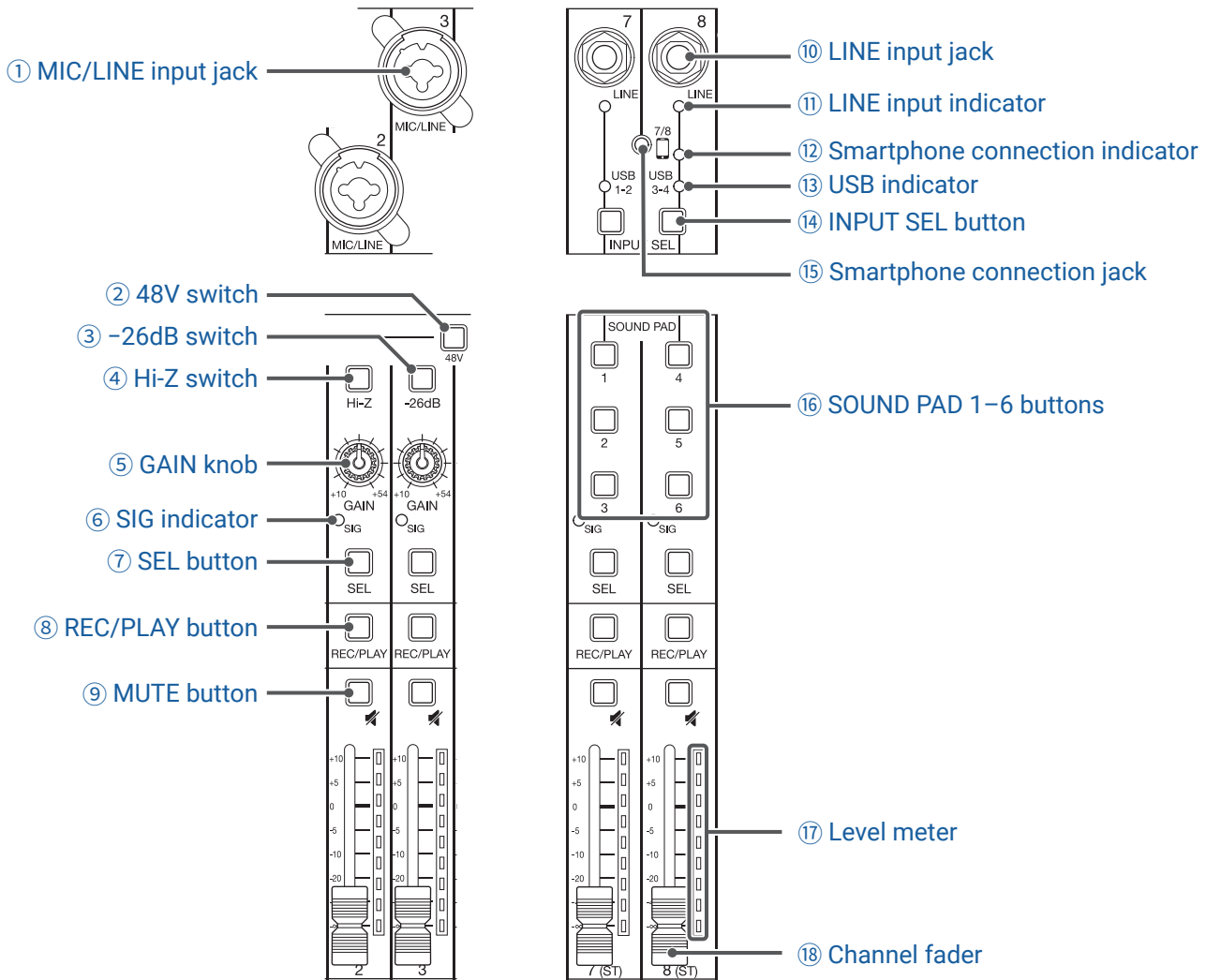

#### ① MIC/LINE input jack

These input jacks have built-in mic preamps. Connect mics, keyboards and guitars to them. These can be used with both XLR and 1/4-inch (balanced or unbalanced) phone plugs.

#### ② 48V switch

This turns +48V phantom power on/off. Turn this on (  ) to supply phantom power to MIC/LINE input jacks 1-6.

#### ③ -26dB switch

This attenuates (reduces) the input signal of the equipment connected to the MIC/LINE input jack (3-6) by 26 dB.

Turn this on (  ) when connecting line level equipment.

#### ④ Hi-Z switch

Use to switch the input impedance of the MIC/LINE input jack (1 or 2).

Turn it on (  ) when connecting a guitar or bass guitar.

#### ⑤ GAIN knob

Use to adjust the input gain of the mic preamp.

The range of adjustment depends on the on/off status of the MIC/LINE input jack switch (Hi-Z on channels 1–2 or –26dB on channels 3–6).

Jack	Adjustment range	
MIC/LINE input jack 1–2 (XLR)	+10 – +54 dB	
MIC/LINE input jack 1–2 (TRS)	Hi-Z off	+10 – +54 dB
	Hi-Z on	–3 – +41 dB
MIC/LINE input jack 3–6	–26dB off	+10 – +54 dB
	–26dB on	–16 – +28 dB

#### ⑥ SIG indicator

This shows the signal level after adjustment by the GAIN knob.

The indicator color changes according to the signal level. Adjust so that it does not light red.

Lit red: Input signal level is close (–3 dBFS or higher) to the clipping level (0 dBFS)

Lit green: Input signal level is between –48 dBFS and –3 dBFS compared to the clipping level (0 dBFS)

#### ⑦ SEL button

Use to select a channel for parameter adjustment in the channel strip section.

Channels with lit SEL buttons are affected by channel strip section adjustments.

#### ⑧ REC/PLAY button

Use this button to switch between recording input signals to the SD card and playing back an already recorded file from the SD card.

Status	Explanation
Lit red	Input signals will be recorded to the SD card after adjustment by the GAIN knob.
Lit green	File playback signals will be input before the equalizer. In this state, signals from input jacks are disabled.
Unlit	Signals from input jacks are enabled.

#### ⑨ MUTE button

This mutes or unmutes signals.

To mute the signal, press this button to light it.

---

#### HINT

This has no effect on recording to the SD card.

---

#### ⑩ LINE input jack

Use this input jack to connect line level equipment. For example, connect a keyboard or audio device.

1/4-inch (unbalanced) phone plugs can be used with it.

#### NOTE

The LINE input jacks and the smartphone connection jack cannot be used at the same time.

⑪ **LINE input indicator**

This lights when the LINE input is enabled.

⑫ **Smartphone connection indicator**

This lights when the Smartphone connection jack is enabled.

⑬ **USB indicator**

This lights when the input of audio return signals output from a computer is enabled.

⑭ **INPUT SEL button**

Use to set the input signal for channel 7/8 to the input jack, the USB audio return, or the SOUND PAD function. Press this button to switch the enabled input.

⑮ **Smartphone connection jack**

Connect a smartphone or similar device here. By using a 4-contact mini-plug cable, the signal can be input from a smartphone and the master mix signal can be sent back (without the channel 8 signal) to it simultaneously.

**NOTE**

The LINE input jacks and the smartphone connection jack cannot be used at the same time. When the smartphone connection jack is enabled as the channel 8 input, channel 7 LINE input is disabled.

⑯ **SOUND PAD 1–6 buttons**

When the SOUND PAD function is enabled, the sounds assigned to each of them can be played. PAD 1–3 sounds are input on channel 7 and PAD 4–6 sounds are input on channel 8.

⑰ **Level meter**

This shows the signal level after adjustment by the channel fader.

Range shown: -48 dB – 0 dB

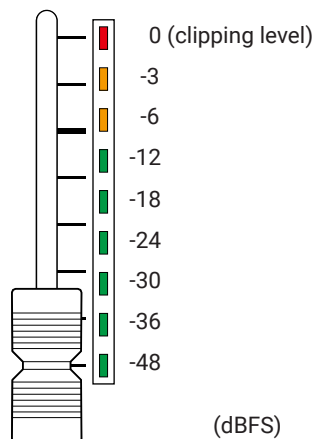

**NOTE**

- If the actual channel fader position differs from the channel fader position recalled using the scene function, for example, the level meter will show the recalled fader position. To enable fader operation, move the fader to the position shown by the level meter.
- The colors of the level meters cannot be shown properly on grayscale devices.

⑱ **Channel fader**

This adjusts the channel signal level in a range from  $-\infty$  to +10 dB.

## CHANNEL STRIP section

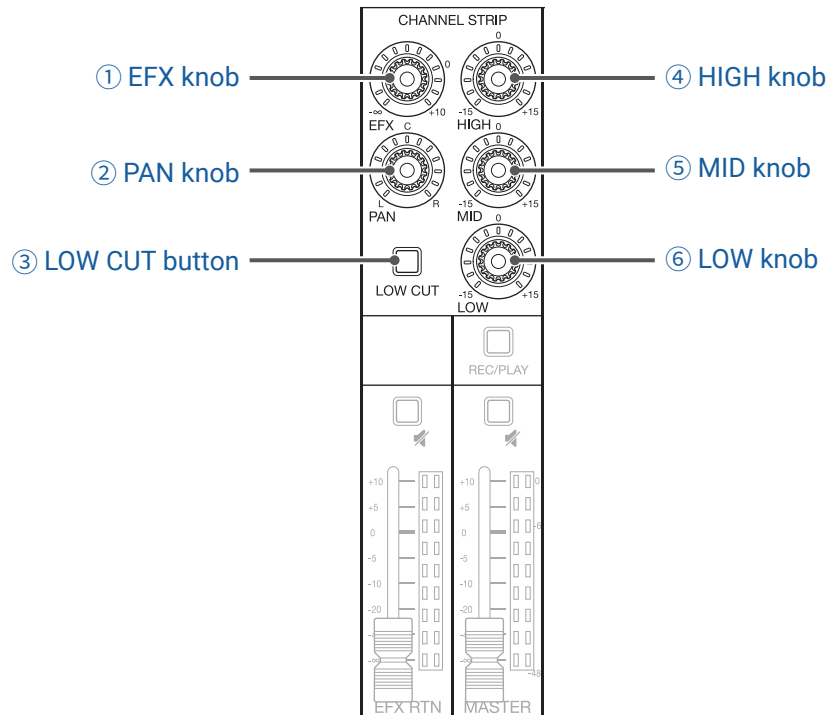

### ① EFX knob

The amount that can be sent to the EFX bus can be set from  $-\infty$  to +10 dB.

### ② PAN knob

This adjusts the position in the stereo output bus.

On channels 7 and 8, this adjusts the left and right volume balance.

### ③ LOW CUT button

This turns on/off the high-pass filter, which cuts low frequencies. When ON, signals below 75 Hz are attenuated 12 dB/octave.

### ④ HIGH knob

This adjusts the boost/cut of high-frequency equalization.

Type: shelving

Gain range: -15 dB – +15 dB

Frequency: 10 kHz

### ⑤ MID knob

This adjusts the boost/cut of mid-frequency equalization.

Type: peaking

Gain range: -15 dB – +15 dB

Frequency: 2.5 kHz

### ⑥ LOW knob

This adjusts the boost/cut of low-frequency equalization.

Type: shelving

Gain range: -15 dB – +15 dB

Frequency: 100 Hz



## Send effect (SEND EFX) section

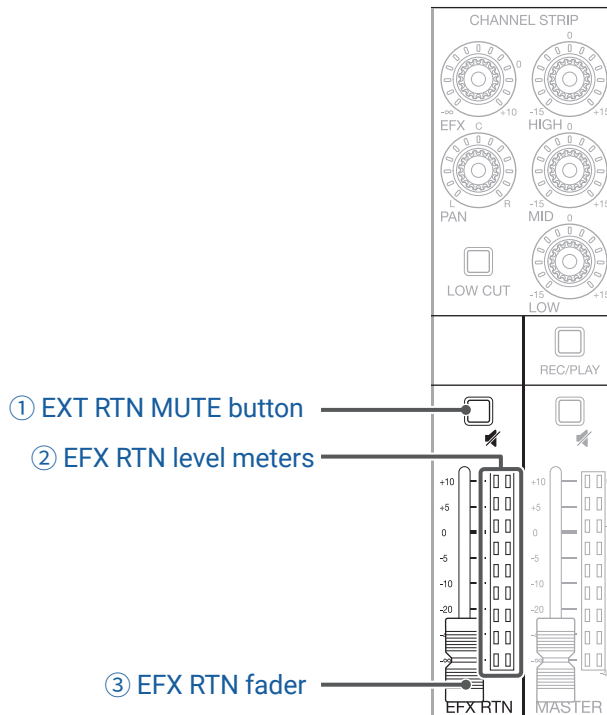

### ① EXT RTN MUTE button

This mutes or unmutes the signal sent from the built-in effect.  
To mute the signal, press this button to light it.

### ② EFX RTN level meters

These show the levels of the signals sent from the built-in effect to the master bus after adjustment by the EFX RTN fader. Their range is from  $-48$  dB to  $0$  dB.

### ③ EFX RTN fader

This adjusts the levels of the signals sent from the built-in effect to the master bus in a range from  $-\infty$  dB to  $+10$  dB.

#### NOTE

If the actual EFX RTN fader position differs from the EFX RTN fader position recalled using the scene function, for example, the level meter will show the recalled fader position. To enable fader operation, move the fader to the position shown by the level meter.

# Output section

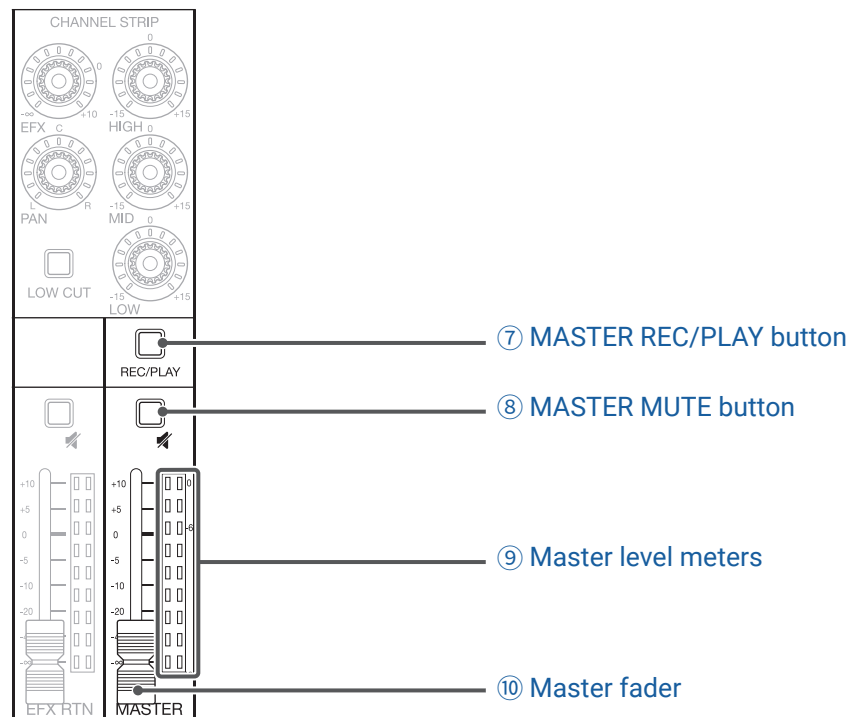
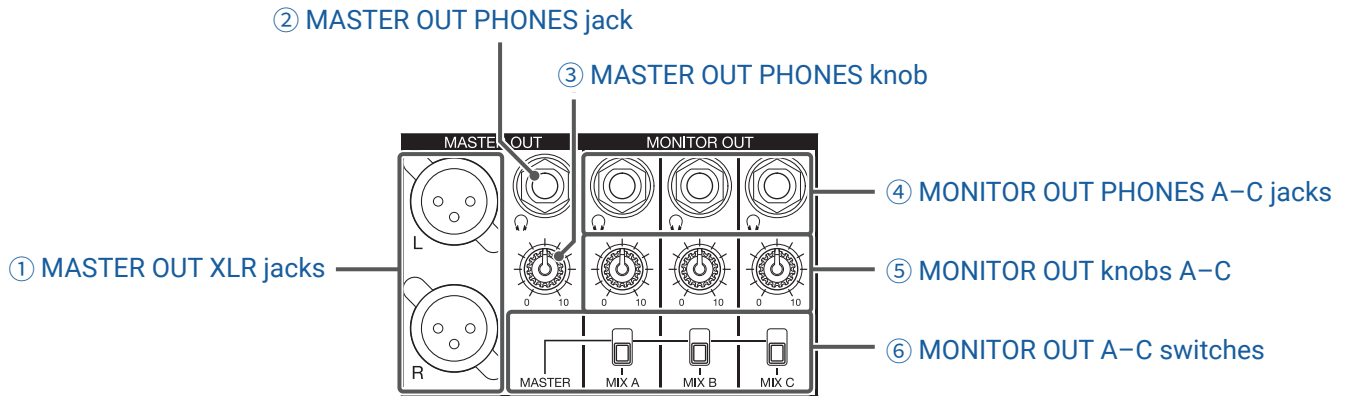

## ① MASTER OUT XLR jacks

These jacks output signals after volume adjustment by the master fader.

Connect them to a power amplifier, a PA system or speakers with built-in amplifiers, for example.

These support balanced output with XLR connectors (2 HOT).

## ② MASTER OUT PHONES jack

This headphone output jack outputs the same signals as the MASTER OUT jacks.

## ③ MASTER OUT PHONES knob

Use to adjust the volume of signals output from the MASTER OUT PHONES jack.

## ④ MONITOR OUT PHONES A-C jacks

These headphone output jacks output signals after volume adjustment by the MONITOR OUT A-C knobs.

### NOTE

The MONITOR OUT PHONES A-C jacks can be set to output the same signals as the MASTER OUT jacks or the signals set separately in MIXER mode. ( → [“Setting signals output from MONITOR OUT A-C” on page 36](#) )

⑤ **MONITOR OUT knobs A–C**

Use to adjust the volumes of the signals output from the MONITOR OUT PHONES A–C jacks.

⑥ **MONITOR OUT A–C switches**

These switch the signals output from the MONITOR OUT PHONES A–C jacks.

Status	Explanation
MASTER	The same signals as those output from the MASTER OUT jacks are output.
MIX A–C	Signals set in MIXER mode are output.

⑦ **MASTER REC/PLAY button**

Use this button to switch between recording the signal input on the master bus to the SD card and playing back an already recorded file from the SD card.

Status	Explanation
Lit red	The signal will be recorded to the SD card after adjustment by the master fader.
Lit green	The playback signal of a file is inserted on the master bus. The REC/PLAY buttons of other channels will become unlit at this time.
Unlit	Files will neither be recorded nor played back.

⑧ **MASTER MUTE button**

This mutes or unmutes the MASTER OUT jacks. To mute the signal, press this button to light it.

⑨ **Master level meters**

These show the signal levels output from the MASTER OUT jacks in a range from –48 dB to 0 dB.

⑩ **Master fader**

This adjusts the signal levels output from the MASTER OUT jacks in a range from  $-\infty$  to +10 dB.

**NOTE**

If the actual master fader position differs from the master fader position recalled using the scene function, for example, the level meter will show the recalled fader position. To enable fader operation, move the fader to the position shown by the level meter.

When AUTO REC is activated, however, the master fader position will not be shown.

# Display, function and mode section

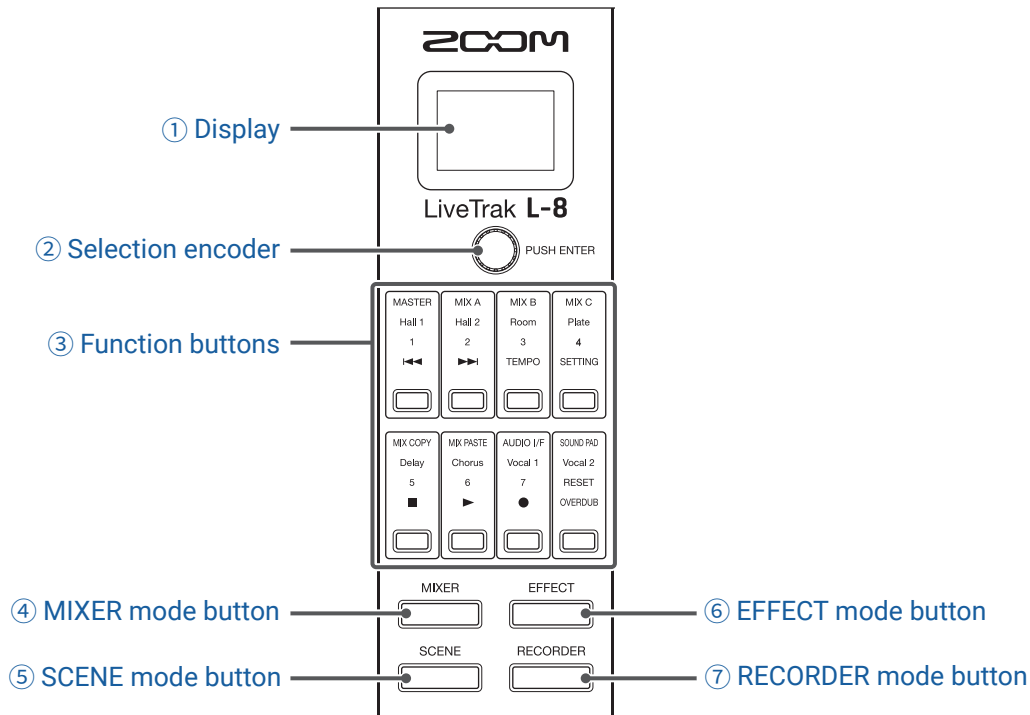

## ① Display

This shows the status of the selected mode and other information. ( → [“Function buttons and display appearance in each mode” on page 13](#) )

## ② Selection encoder

Use this to change menus and values and to move between items.

## ③ Function buttons

The functions change according to the selected mode. ( → [“Function buttons and display appearance in each mode” on page 13](#) )

## ④ MIXER mode button

This enables the MIXER mode functions of the function buttons and opens the MIXER screen on the display. In MIXER mode, the layers used for mixing can be checked and changed. In addition, mixes can be copied and audio interface and SOUND PAD settings can be changed.

Press this when making settings to return to the MIXER screen.

## ⑤ SCENE mode button

This enables the SCENE mode functions of the function buttons and opens the SCENE screen on the display. In SCENE mode, scenes can be changed and saved and the mixer can be reset.

## ⑥ EFFECT mode button

This enables the EFFECT mode functions of the function buttons and opens the EFFECT screen on the display. In EFFECT mode, effects can be selected, checked and adjusted.

## ⑦ RECORDER mode button

This enables the RECORDER mode functions of the function buttons and opens the RECORDER screen on the display. In RECORDER mode, recorder operations are enabled. In addition, the SETTING screen where various **L-8** settings are made can be opened.

Press this when making settings to return to the RECORDER screen.

# Function buttons and display appearance in each mode

## MIXER mode

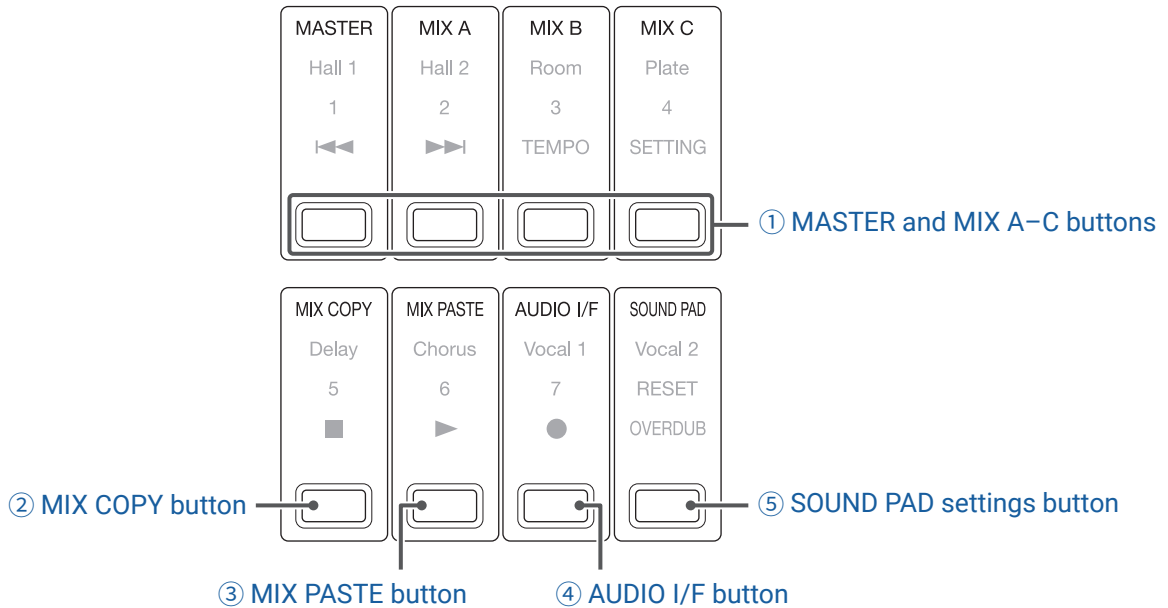

### ① MASTER and MIX A–C buttons

The signal balance set using the channel faders can be switched as layers according to the outputs you want to show and adjust.

- MASTER button: Show and adjust the settings used for MASTER OUT output.
- MIX A–C buttons: Show and adjust the settings used for MONITOR OUT A–C outputs.

#### NOTE

- The following parameters can have separate settings for the MASTER and MONITOR OUT A–C.
  - Fader positions (each channel)
  - Fader positions (EFX RETURN)
- The following parameters are shared by the MASTER and the MONITOR OUT A–C mixes.  
MUTE ON/OFF, LOW CUT ON/OFF, EQ HIGH, EQ MID, EQ LOW, SEND EFX, PAN, SEND EFX TYPE, SEND EFX parameters 1 and 2

### ② MIX COPY button

This copies fader position information for the currently selected mix.

### ③ MIX PASTE button

This applies the copied fader position information to the currently selected mix.

### ④ AUDIO I/F button

This opens a screen where audio interface function settings can be changed.

### ⑤ SOUND PAD settings button

This opens a screen where SOUND PAD settings can be changed.

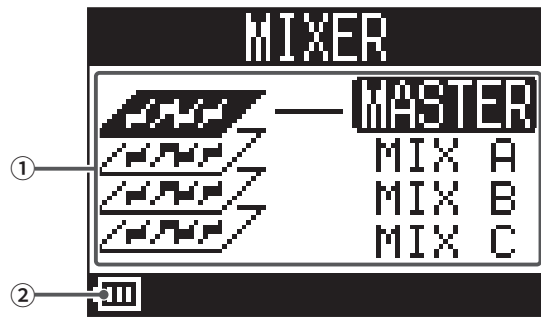

No.	Item	Explanation
①	Selected mix	This highlights the selected mix.
②	Remaining battery charge (when battery-powered)	This shows the remaining battery charge. When the remaining battery charge becomes low, replace the batteries or connect an AC adapter.

## EFFECT mode

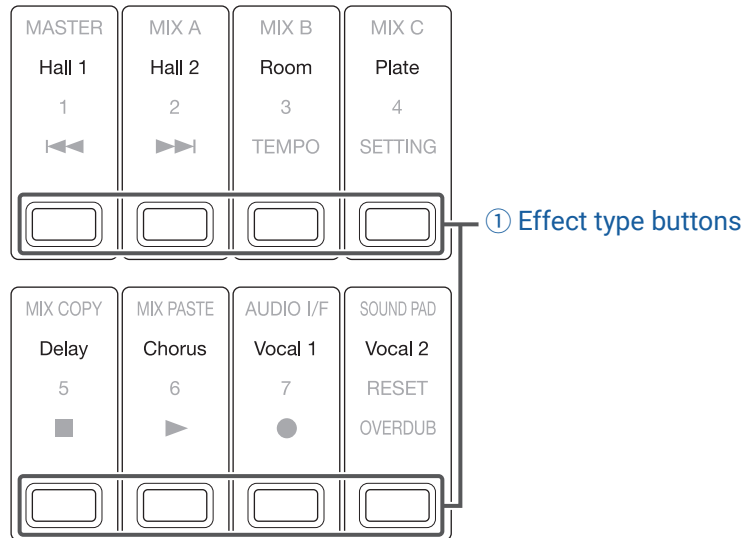

### ① Effect type buttons

The currently selected effect type appears lit.

Press a button to change the effect. The selected effect will be shown on the display. Its parameters can be changed using the Selection encoder.

( → [“Send effect specifications” on page 111](#) )

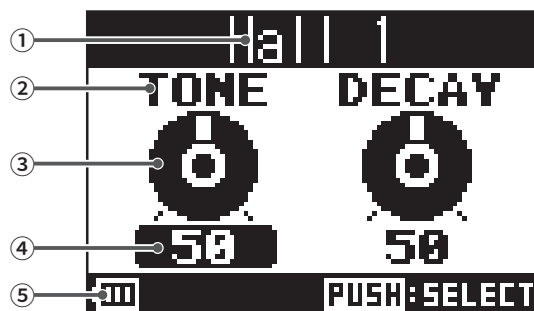

No.	Item	Explanation
①	Effect type	This shows the selected effect type.
②	Parameter	This shows the name of an adjustable effect parameter.
③	Parameter knob	This shows a parameter knob. The knob position shows the parameter setting value.
④	Parameter setting value	This shows the parameter setting value. It appears highlighted when selected.
⑤	Remaining battery charge (when battery-powered)	This shows the remaining battery charge. When the remaining battery charge becomes low, replace the batteries or connect an AC adapter.

## SCENE mode

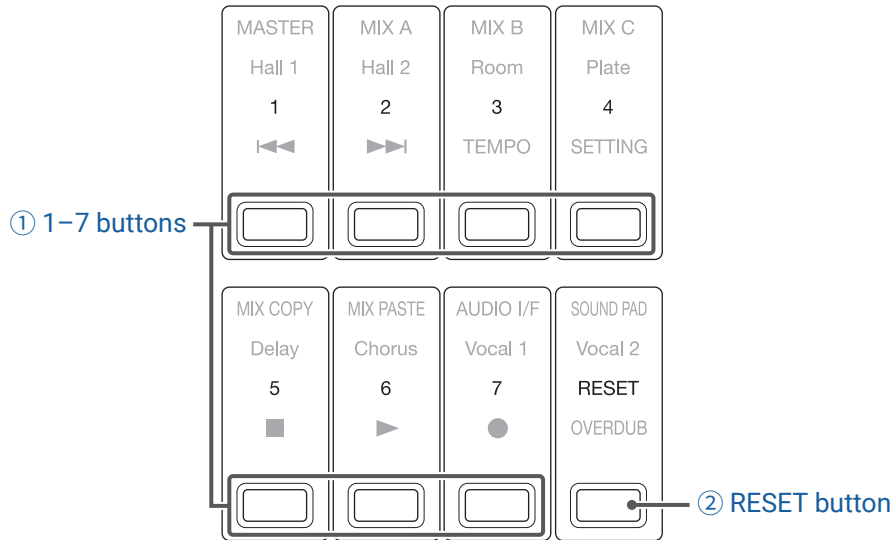

### ① 1-7 buttons

Use these buttons to select the scene used to save the current mixer settings and to recall saved scenes. Press these buttons to open screens where SAVE, RECALL and CANCEL can be selected.

### ② RESET button

Press this button to reset the current mixer settings to the factory defaults. Press this button to open a screen where RECALL and CANCEL can be selected.

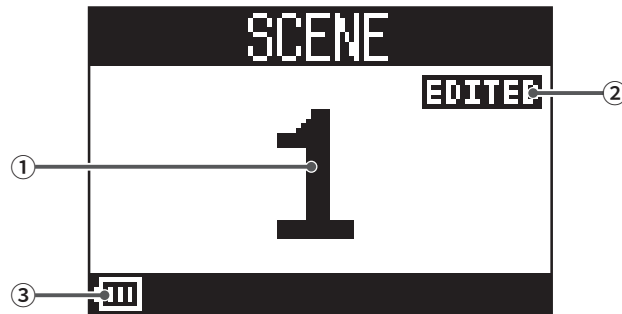

No.	Item	Explanation
①	Scene number	This shows the number of the selected scene. "NOT SELECTED" will appear when none is selected.
②	EDITED status	This appears if the selected scene has been changed.
③	Remaining battery charge (when battery-powered)	This shows the remaining battery charge. When the remaining battery charge becomes low, replace the batteries or connect an AC adapter.



## RECORDER mode

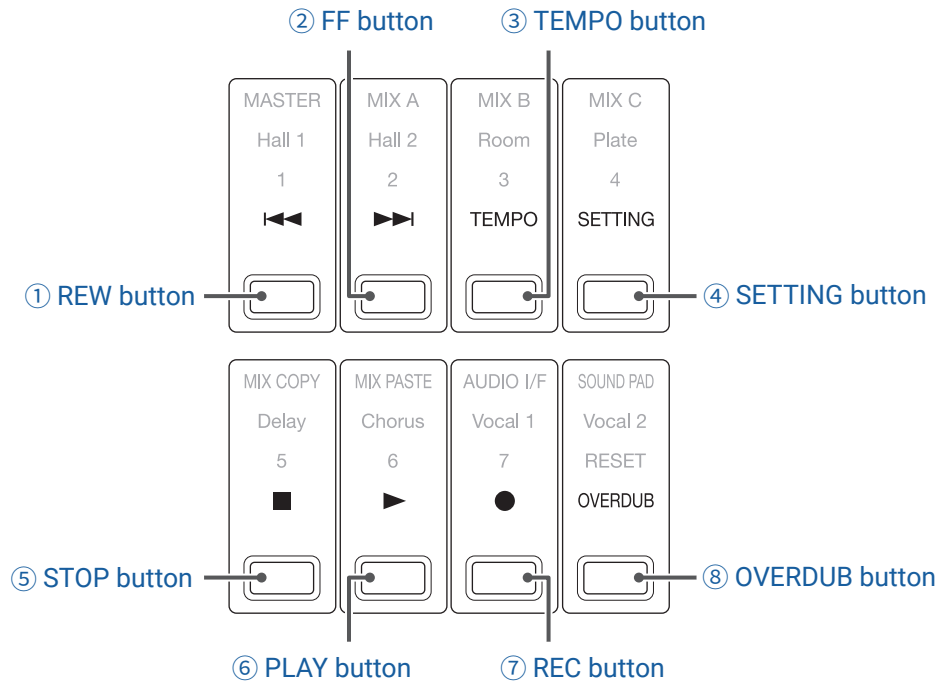

### ① REW button

Press to move to the previous mark.

Press when at the beginning to move to the previous project. Press and hold to search backward. (The longer pressed, the faster the speed becomes.)

### ② FF button

Press to move to the next mark.

If it is the last mark, this moves to the next project. Press and hold to search forward. (The longer pressed, the faster the speed becomes.)

### ③ TEMPO button

This sets the tempo of the metronome built into the recorder.

The tempo will be detected from the average value when this button is pressed repeatedly.

When the METRONOME setting is enabled, during recording and playback and when the Delay effect, which synchronizes with tempo, is selected, the button blinks at a tempo of 40.0–250.0 bpm.

### ④ SETTING button

Press to open the SETTING screen.

### ⑤ STOP button

This stops the recorder.

### ⑥ PLAY button

Press to start recorder playback.

- During playback, it lights green.
- When playback is paused, it blinks green.

### ⑦ REC button

This puts the recorder in recording standby.

- During recording, it lights red.
- When recording is paused, it blinks red.

### ⑧ OVERDUB button

This sets whether recording is overdubbed in the current project or whether a new project is created and new recording conducted. When on, this button lights and overdubbing occurs in the current project.

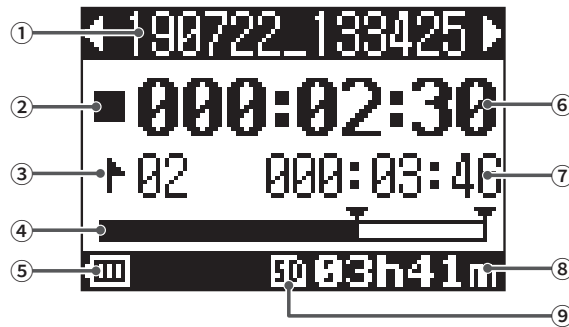

No.	Item	Explanation
①	Project name	This shows the project name. " < " appears if there is another project before this one in the folder. " > " appears if there is another project after this one in the folder.
②	Status icon	This shows the status as follows. ■: Stopped ▬▬: Paused ●: Recording ▶: Playing back
③	Mark	This shows the mark number and the status as follows. ▬: At mark (A mark has been added at the counter location.) ┆: Not at mark (No mark has been added at the counter location.)
④	Progress bar	The progress bar shows the amount of time from the beginning to the end of the project.
⑤	Remaining battery charge (when battery-powered)	This shows the remaining battery charge. When the remaining battery charge becomes low, replace the batteries or connect an AC adapter.
⑥	Counter	This shows the time in hours, minutes and seconds.
⑦	Longest file time in project	This shows the length of the longest file in the project.
⑧	Remaining recordable time	This shows the remaining recordable time. This will change automatically according to the number of channels that have recording enabled with  .
⑨	SD card icon	This is shown when an SD card is detected.

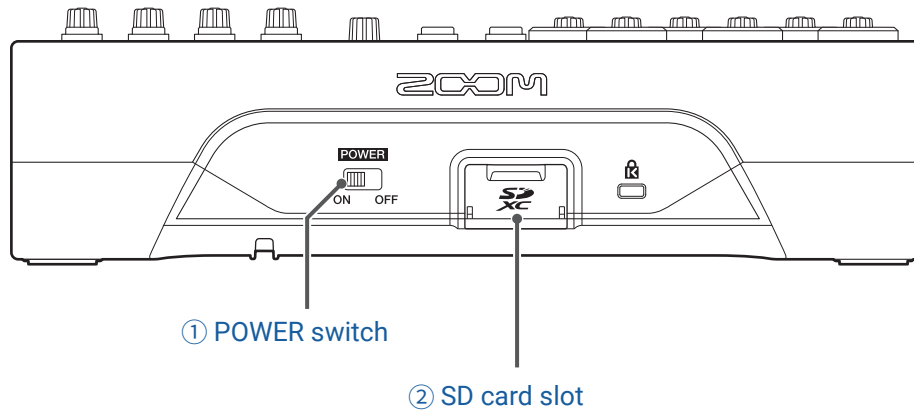

## ① POWER switch

This turns the **L-8** power on and off.

Switch to ON to turn the power on. Switch to OFF to turn the power off.

When the POWER switch setting is changed to OFF, the current mixer settings are automatically saved in the **L-8** and in the settings file in the project folder on the SD card.

## ② SD card slot

This slot is for SD cards.

The **L-8** supports cards that conform to SDHC and SDXC specifications.

---

### HINT

SD cards can be tested for usability with the **L-8**. (→ [“Testing SD card performance” on page 93](#))

---

# Bottom

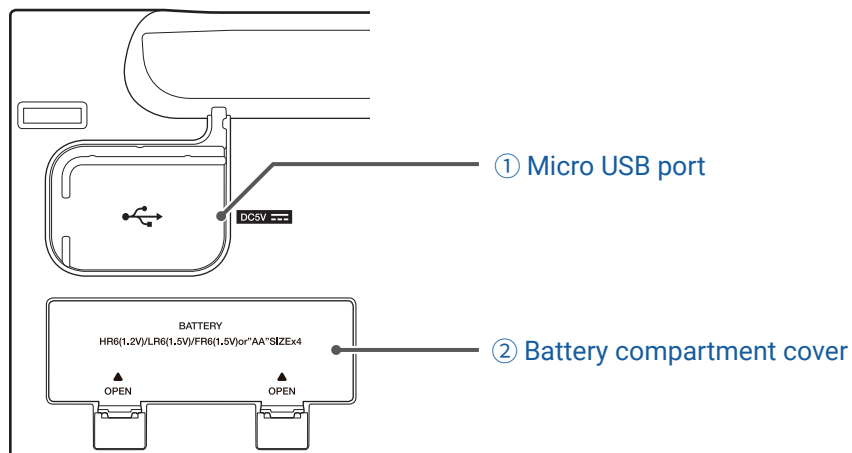

## ① Micro USB port

This Micro USB 2.0 port can be used to connect an AC adapter or computer. A mobile battery, for example, can also be connected to run on bus power.

## ② Battery compartment cover

Remove when installing or removing batteries.

The **L-8** can run on 4 AA batteries.

# Equipment connection examples

## Podcasting

Mics with tabletop stands

Headphones

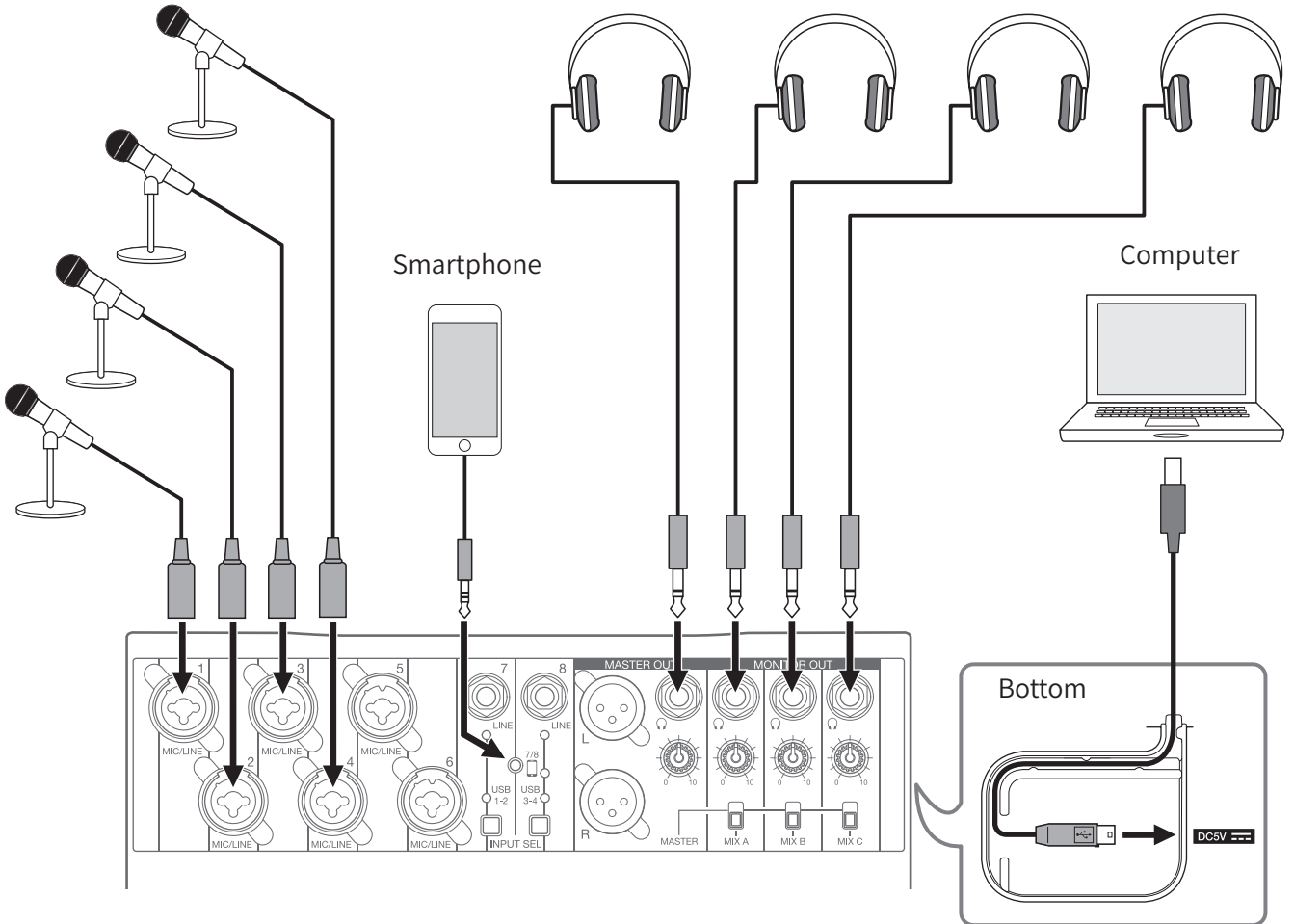

# Live PA system

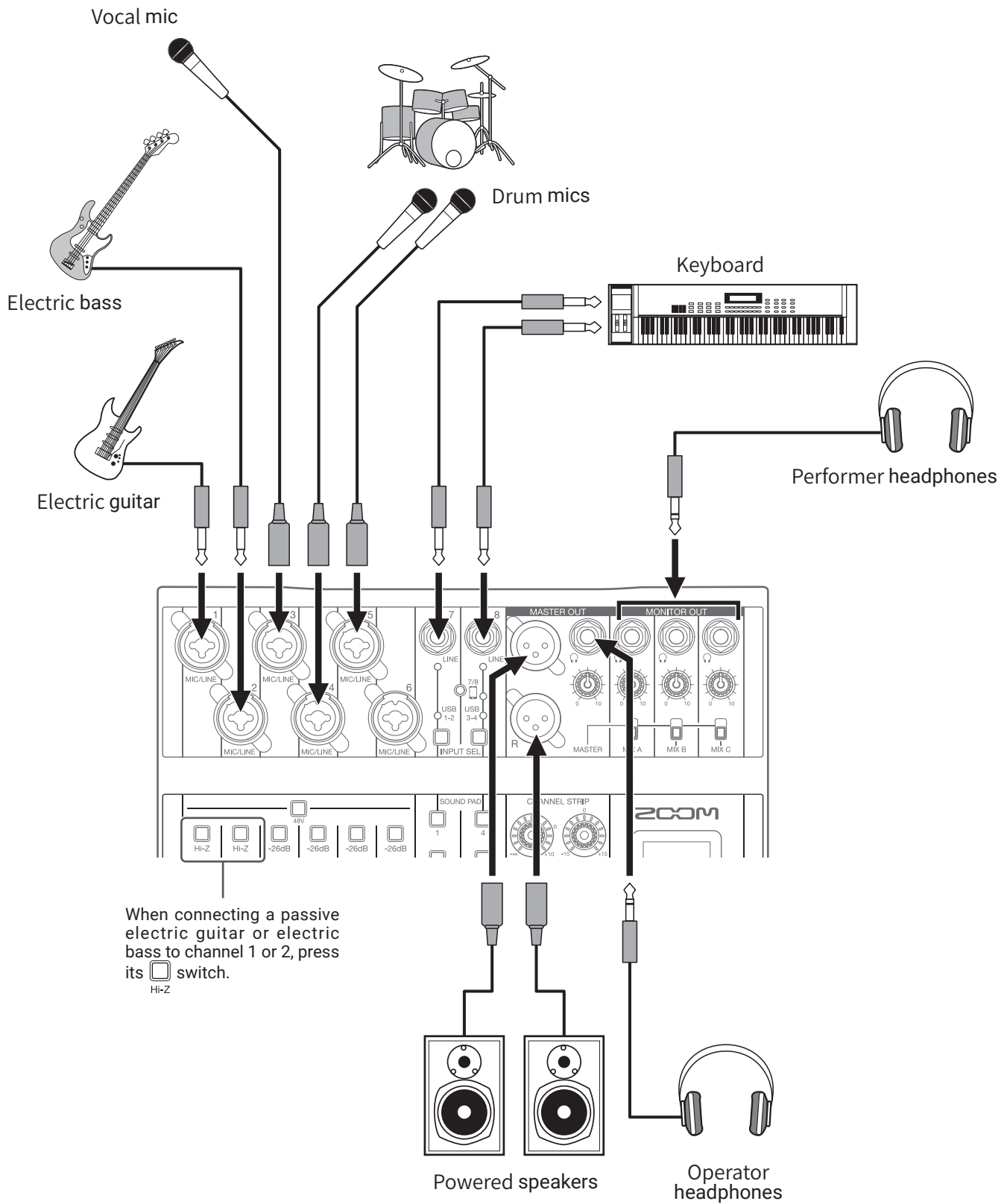

# Preparations

## Providing power

### Using an AC adapter

1. Connect the cable of the dedicated AD-17 AC adapter to the Micro USB port.

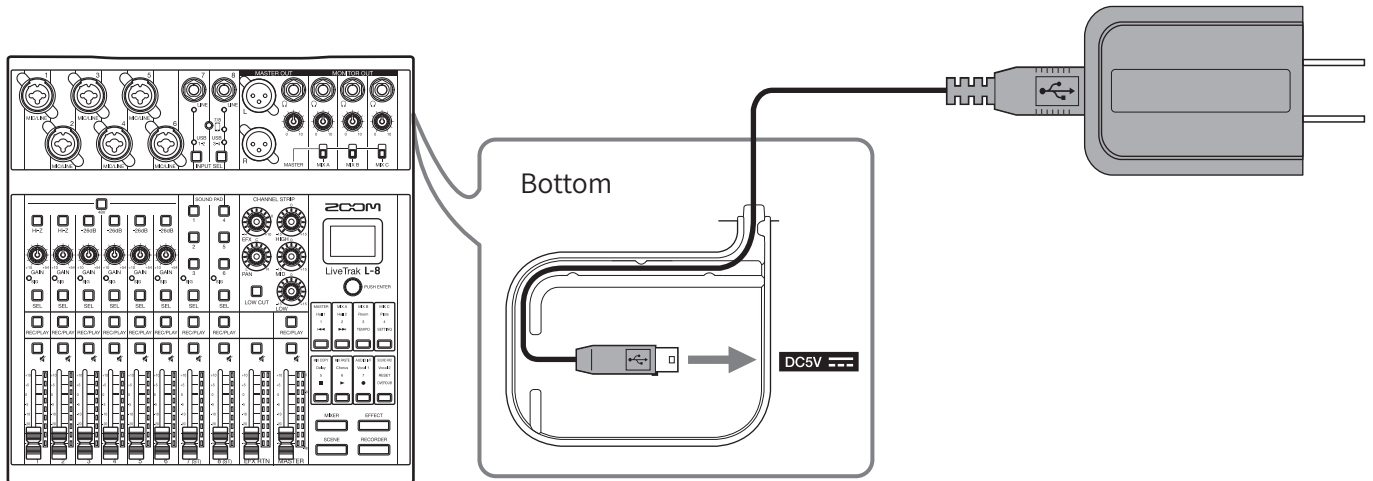

2. Plug the dedicated AC adapter into an outlet.

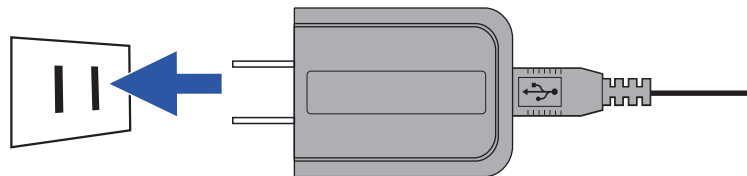

#### HINT

- When connected to a computer, power can be supplied by USB.
- A mobile battery can be connected instead of a dedicated AC adapter.

## Using batteries

---

1. Open the battery compartment cover on the bottom of the product and insert 4 AA batteries.

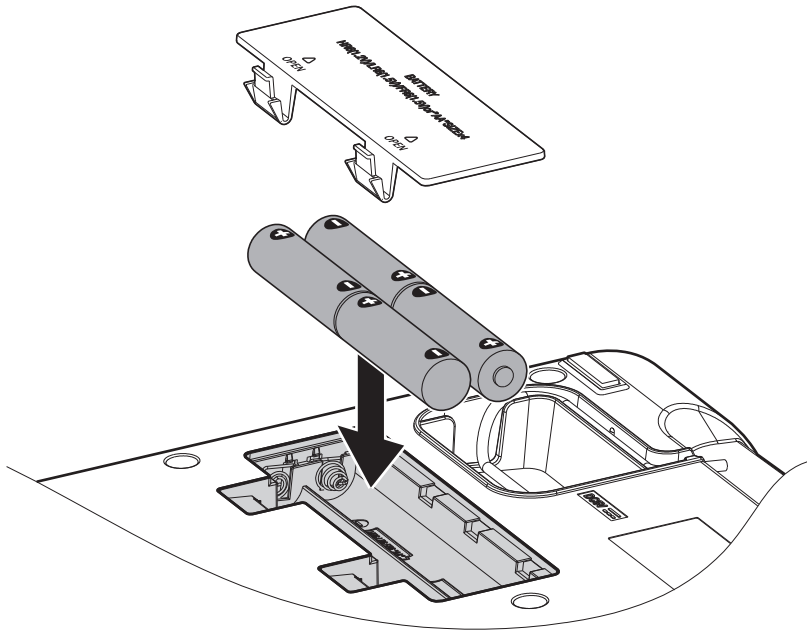

2. Replace the battery cover.

### NOTE

- Use only one type of battery (alkaline, NiMH or lithium) at a time.
- If the remaining battery power indicator drops to 0, turn the power off immediately and install new batteries.
- After installing the batteries, set the battery type correctly. (→ [“Setting the type of batteries used” on page 101](#))



# Turning the power on and off

## Turning the power on

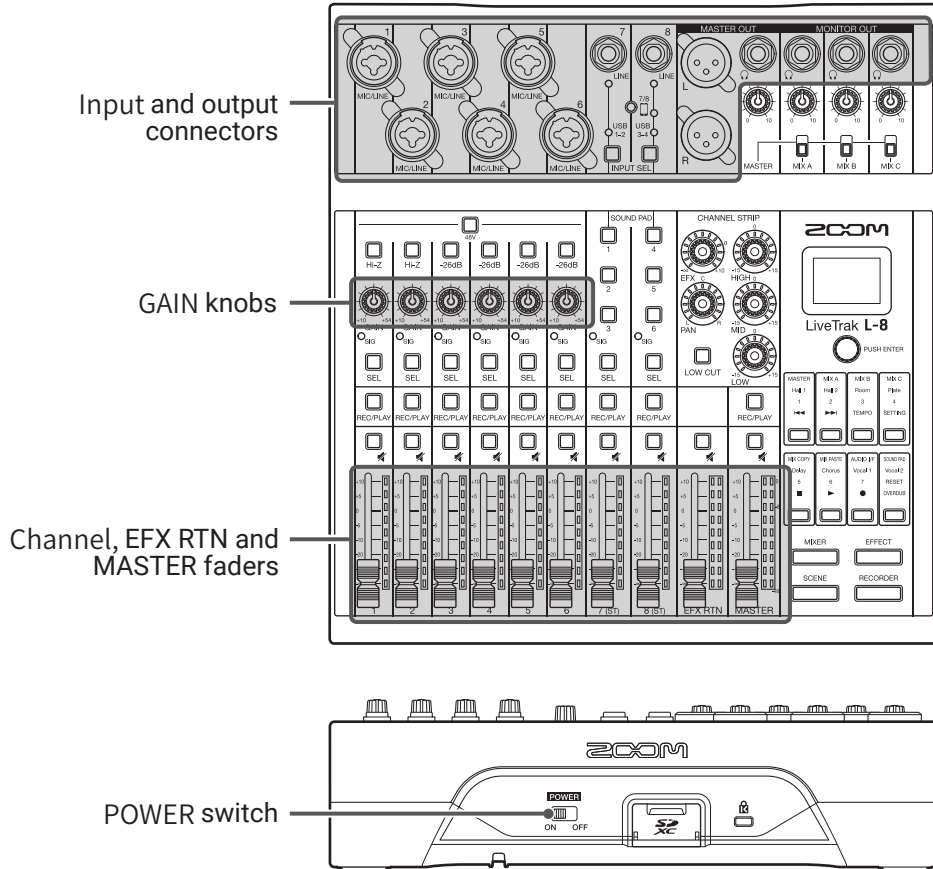

1. Confirm that the output devices connected to the **L-8** are turned off.

2. Confirm that  is set to OFF.

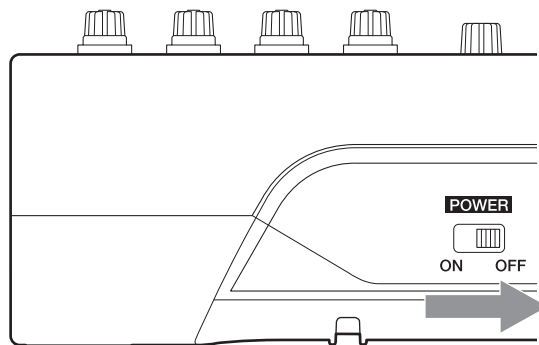

3. Set all  knobs and faders to their minimum values.

## 4. Connect instruments, mics, speakers and other equipment.



### HINT

Equipment connection examples ( → [“Equipment connection examples” on page 21](#))

## 5. Set to ON.

## 6. Turn on the output devices connected to the **L-8**.

### NOTE

- When using a passive guitar or bass guitar, connect it to channel 1 or 2, and turn  on. ( → [“Top” on page 5](#))
- When using a condenser mic, turn  on. ( → [“Top” on page 5](#))
- The power will automatically turn off if the **L-8** is unused for 10 hours. To keep the power on at all times, disable the automatic power saving function. ( → [“Disabling the automatic power saving function” on page 98](#))

## Turning the power off

## 1. Minimize the volume of output devices connected to the **L-8**.

## 2. Turn off the power of output devices connected to the **L-8**.

## 3. Set to OFF.

The following screen appears and the power turns off.



### NOTE

When the power is turned off, the current mixer settings are saved in the project on the SD card. If they cannot be saved to the SD card, they will be saved in the **L-8**.

# Using the SETTING screen

Use the SETTING screen to make **L-8** recorder function settings, for example. This is an explanation of the basic operations.

Open the SETTING screen: Press , and then press 

This opens the SETTING screen.

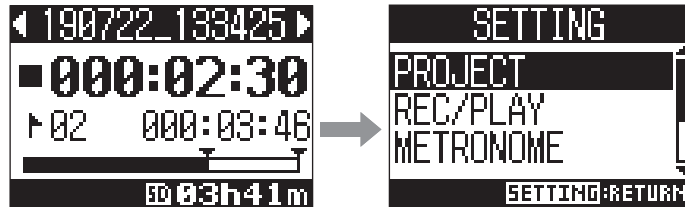

Select setting items and parameters: Turn 

This moves the cursor.

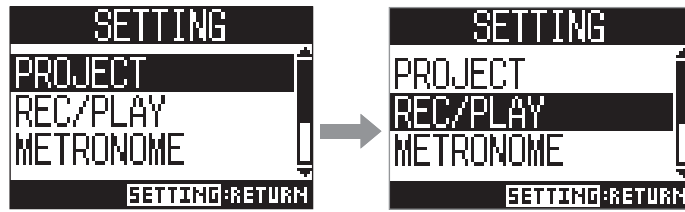

Confirm setting items and parameters: Press 

This opens the selected item screen or parameter setting screen.

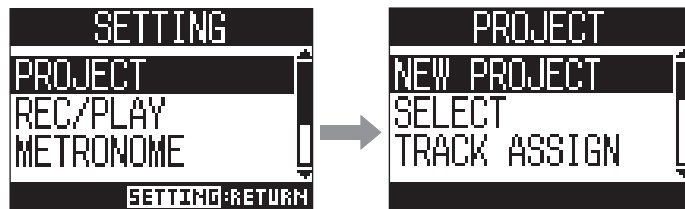

Return to previous screen: Press 

This opens the selected item screen or parameter setting screen.

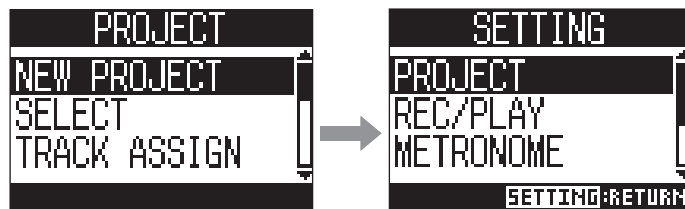

On the following pages, SETTING screen operations are shown in the following way.  
For example, "After selecting 'METRONOME', select 'CLICK'" becomes:  
Select **METRONOME** > **CLICK**.

# Mixer

## Outputting input sounds from output devices

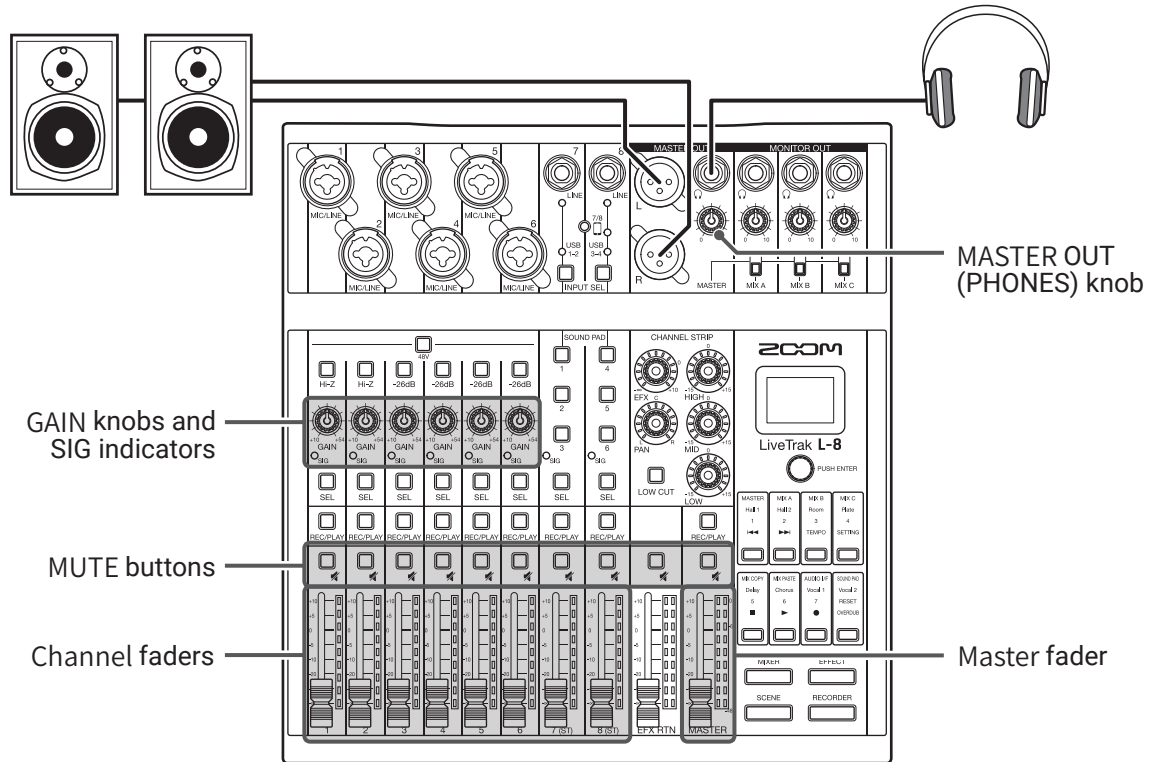

1. Use  to adjust the input signals while inputting sound from instruments and mics.

### NOTE

Set them so that the SIG indicators do not light red.



2. Turn  off (unlit) for the MASTER and the channels with sound you want to output.

3. Set the MASTER fader to 0.

4. Use the channel faders to adjust the volumes.

5. Use the MASTER fader to adjust the overall volume.

6. Use  to adjust the headphone volume.

# Switching channel 7 and 8 inputs

Channels 7 and 8 can use the following inputs.

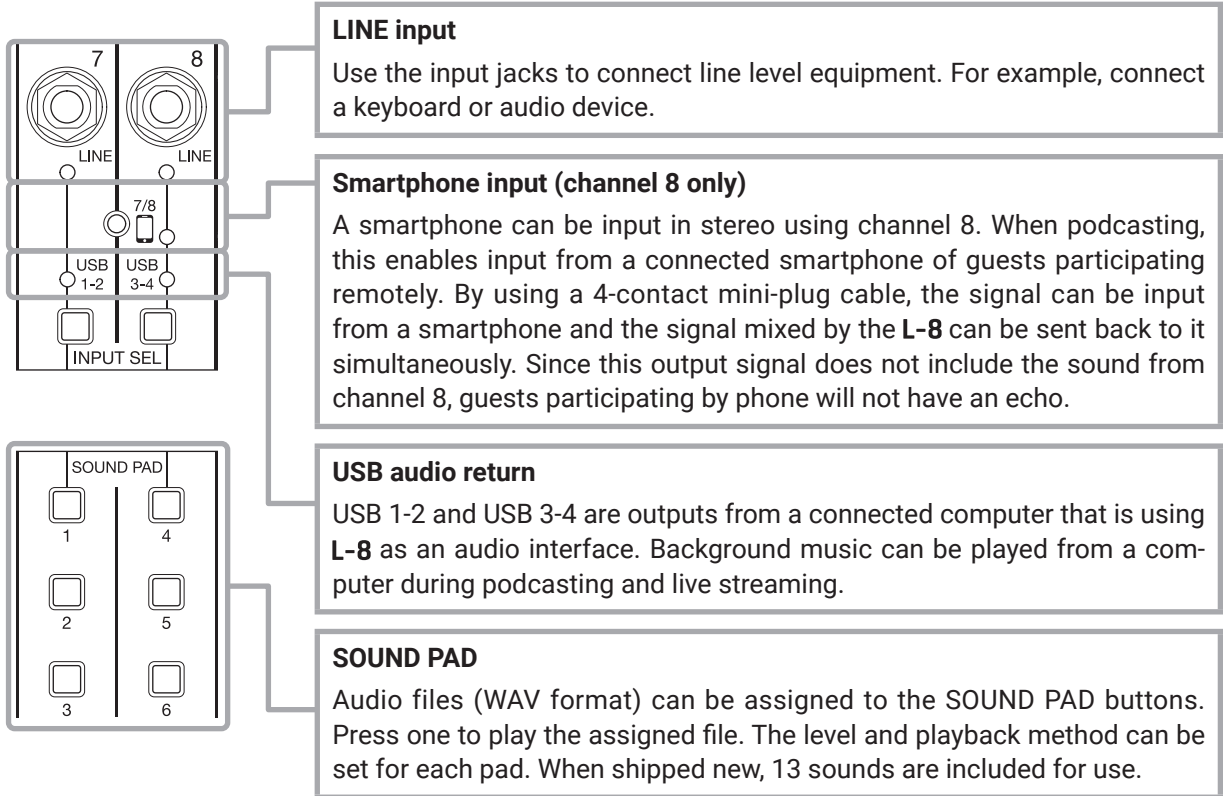

## Switching inputs

1. Press  for channel 7/8 to select the input. The LED for the selected input lights.

- **Channel 7**

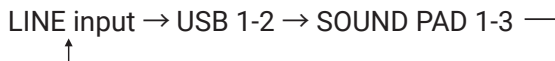

- **Channel 8**

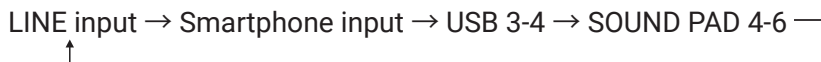

**NOTE**



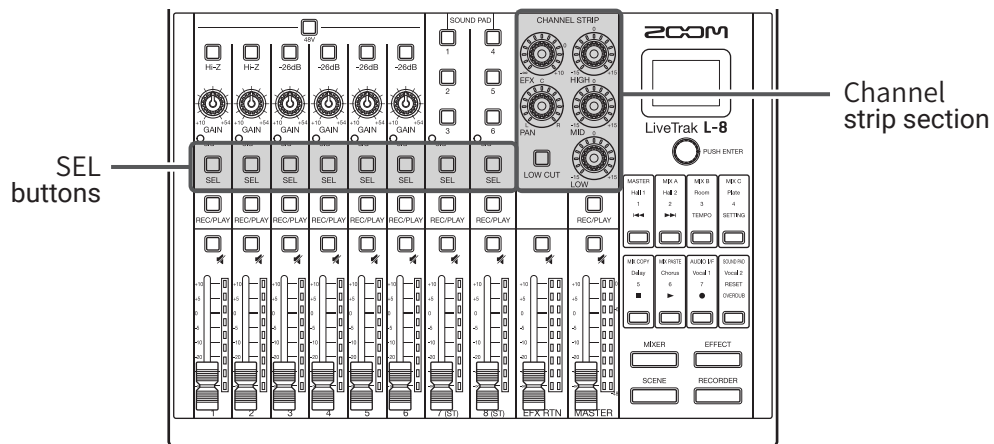

Channel 8 smartphone input and channel 7 LINE input cannot be selected at the same time. Doing so will cause the channel 7 LINE indicator to blink.

# Adjusting the tone and panning



**1.** To enable tone and panning adjustment on a channel, press  to light it.

**2.** Use the knobs and buttons in the channel strip section to adjust the tone and panning.

Adjusting the tone:  ,  ,  , 

Adjusting the panning: 

## HINT

Details about each knob and button ( → [“CHANNEL STRIP section” on page 8](#) )

# Using the built-in effects

The **L-8** has 8 types of send effects that can be used in 1 effect channel.

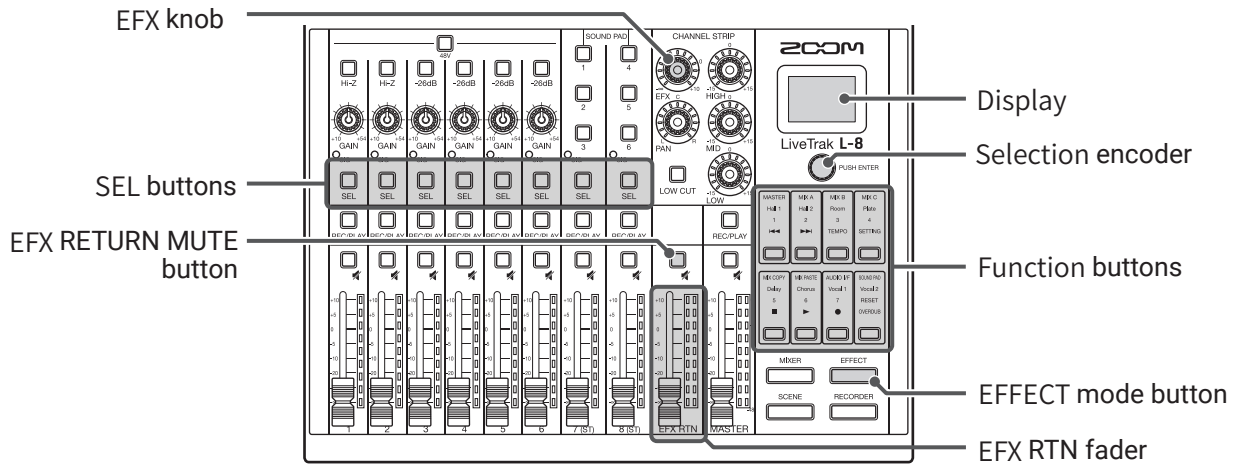

1. Press  so that it lights.  
The currently selected effect type is shown on the display.

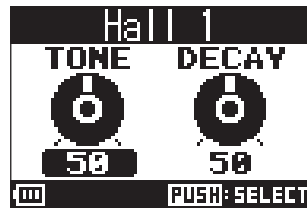

2. Press a  function button to select that effect.



The button for the selected effect lights.

3. Set the EFX RTN  to OFF (unlit).



4. Set the EFX RTN fader to 0.

5. Press  for a channel that you want to use the effect on to light it.

6. Use  to adjust the amount for each channel.

7. Use the EFX RTN fader to adjust the overall effect amount.

8. Use  to adjust the effect parameters.

- Adjust parameter: Turn 
- Select parameter: Press 

**NOTE**

The parameters of each effect type that can be adjusted using  are listed here ( → [“Send effect specifications” on page 111](#)).



# Using scene functions

Scene functions can be used to save up to 7 sets of current mixer settings as scenes and to recall these saved settings at any time.

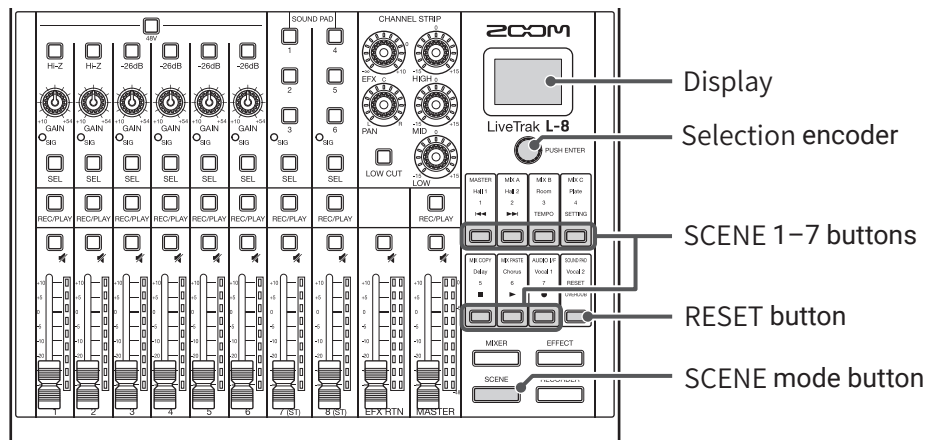

## Saving scenes

1. Press  so that it lights.  
This opens the SCENE screen.

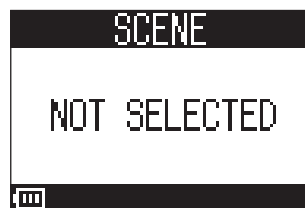

2. Press the  button (SCENE 1-7) to select the save destination.

3. Turn  to select **SAVE**, and press .

To not save the scene, turn , select **CANCEL**, and press .

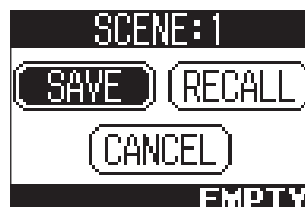

## NOTE

- The **L-8** can store 7 scenes.
- If a button that already has a scene saved is selected, that scene will be overwritten.
- The following items are saved with scenes.
  - Fader positions (each channel, EFX 1/2 RTN and MASTER)
  - MUTE ON/OFF (each channel, EFX 1/2 RTN and MASTER)
  - LOW CUT
  - EQ HIGH
  - EQ MID
  - EQ LOW
  - SEND EFX
  - PAN
  - EFX TYPE
  - EFX parameters
  - INPUT SEL settings

## Recalling scenes

1. Press  so that it lights.  
This opens the SCENE screen.

2. Press the  button (SCENE 1–7) for the scene to recall.

3. Turn  to select **RECALL**, and press .

To not recall the scene, turn , select **CANCEL**, and press .

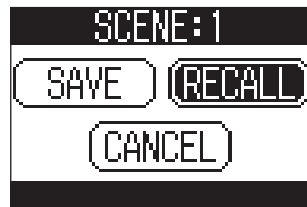

## NOTE

- If the actual channel fader position differs from the channel fader position shown, the volume will not change until the fader is moved to the same position. ( → [“Input channel section” on page 5](#) )
- “Empty” will appear at the bottom right of the display if the scene has not been saved.

# Resetting mixer settings

---

1. Press  so that it lights.  
This opens the SCENE screen.

2. Press .

3. Turn  to select **RECALL**, and press .

The current mixer settings are reset to their factory defaults.

To not reset the scene, turn , select **CANCEL**, and press .



# Setting signals output from MONITOR OUT A–C

The MONITOR OUT A–C jacks can be set to output the same mix as the MASTER OUT or different mixes.

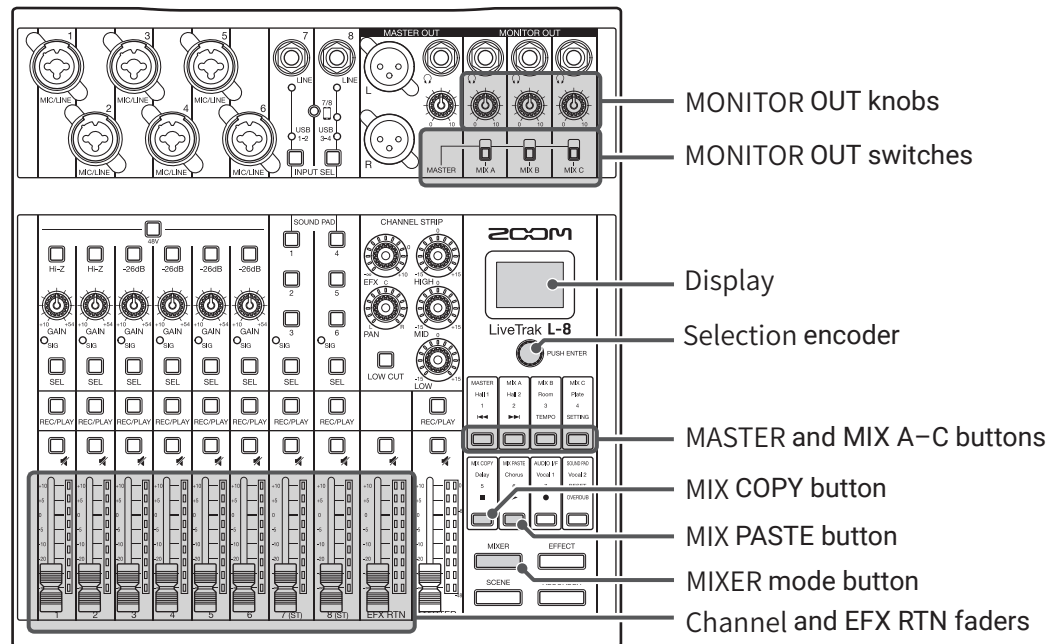

## Adjusting the MONITOR OUT A–C mixes

1. Press  so that it lights.  
This opens the MIXER screen.

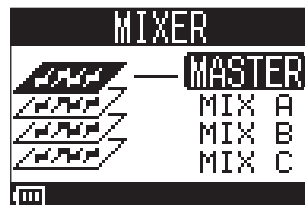

2. Press a  –  button to select the output to mix.

The selected output button lights and operation of all the channel faders is enabled.

### NOTE

The level meters show the fader positions. If the actual channel fader position differs from the channel fader position shown, the volume will not change until the fader is moved to the same position.

### HINT

The  can also be turned to select MIX A, MIX B or MIX C.

3. Use the channel and EFX RTN faders to adjust the volumes.

## Adjusting the MONITOR OUT A–C volumes

1. Turn  for MONITOR OUT A–C.

## Selecting MONITOR OUT A–C output signals

1. Use the MONITOR OUT switch for an output to select its output signal.

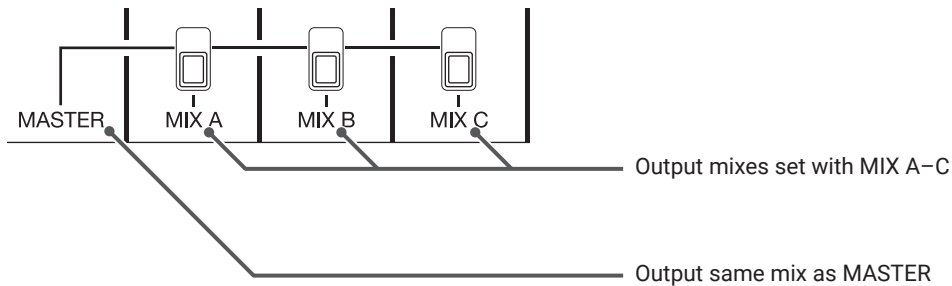



### NOTE

- Each output mix is saved with the scene and project.
- The parameters that can have separate settings for the MASTER and MIX A–C are as follows.
  - Fader positions (each channel)
  - EFX RTN fader positions

## Copying a mix

1. Press  so that it lights.  
This opens the MIXER screen.

2. Press ,  –  for the mix that you want to copy.

3. Press .



4. Press ,  –  for the mix destination.

5. Press .

This copies the mix from the source to the destination.



# Connecting smartphones

The **L-8** has a smartphone connection jack. By connecting a smartphone to this jack using a 4-contact mini-plug (TRRS) cable, the audio signal from the smartphone can be input on **L-8** channel 8. Moreover, the **L-8** mix output signal can be input to the smartphone. This feature enables guests to participate in podcasts by phone.

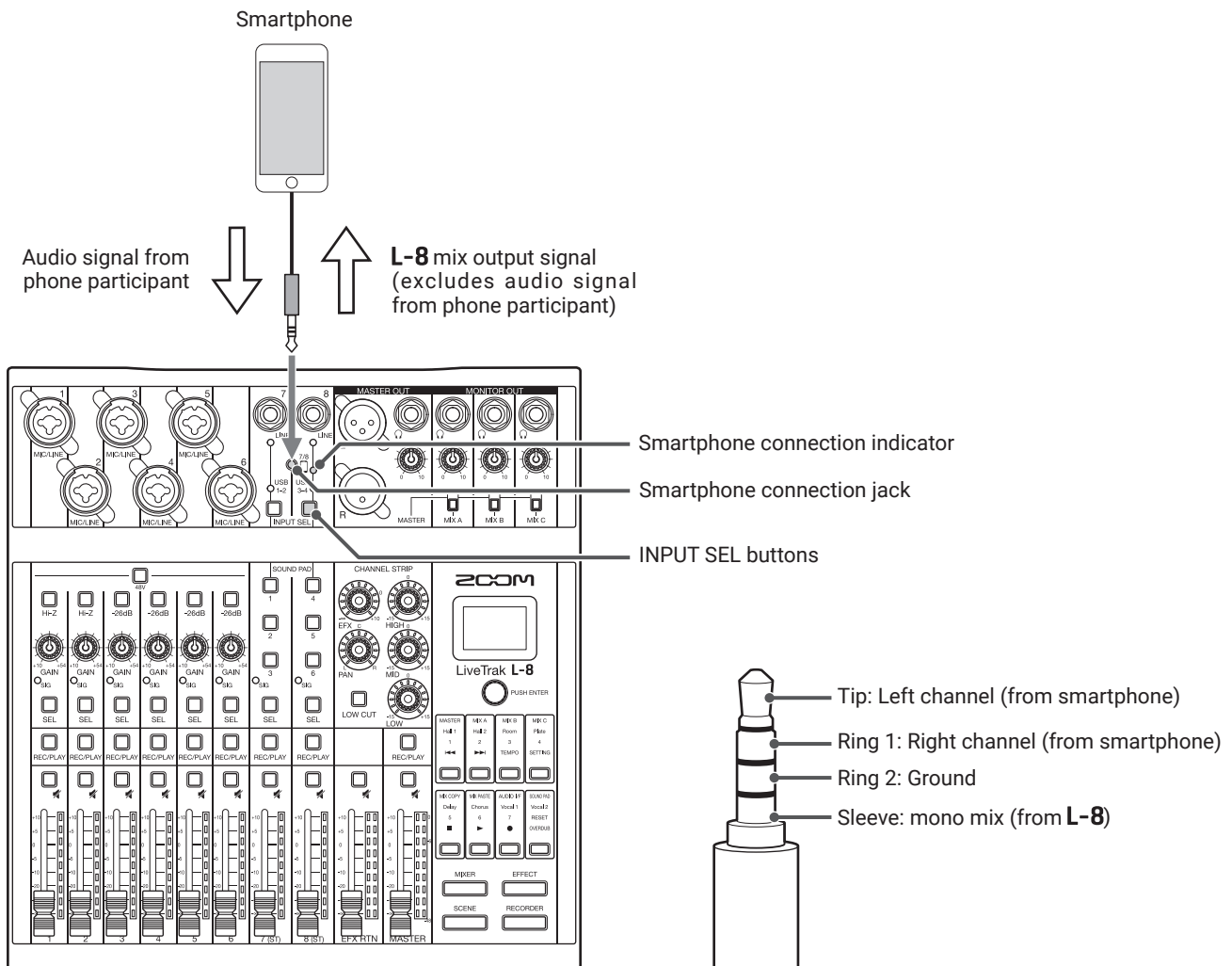

**1.** Connect a smartphone to the smartphone connection jack on the **L-8**.

**2.** Press  for channel 8 to light the smartphone input indicator ( → [“Switching channel 7 and 8 inputs” on page 29](#)).

## HINT

- The **L-8** returns the output signal to the smartphone, but this output signal does not include the sound from the smartphone, so guests participating by phone will not have an echo.
- A stereo mini-plug cable can be used instead of a 4-contact mini-plug (TRRS) cable to connect a smartphone. In this case, the audio signal from the smartphone will be input to the **L-8**, but the **L-8** mix output signal will not be input to the smartphone.

# Recording and playback

## Preparing to record

### Inserting SD cards

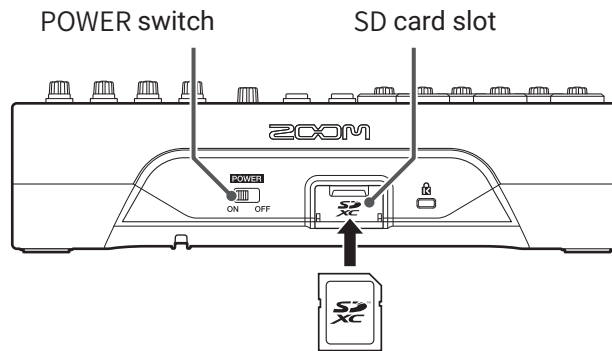

1. Set  to OFF.

2. Open the SD card slot cover, and insert an SD card all the way into the slot.

To remove an SD card, push it further into the slot and then pull it out.

#### NOTE





- Disable write-protection on the SD card before inserting it.
- Always set  to OFF before inserting or removing an SD card.  
Inserting or removing a card while the power is on could result in data loss.
- When inserting an SD card, be sure to insert the correct end with the top side up as shown.
- If an SD card is not loaded, recording and playback are not possible.
- Formatting an SD card ( → [“Formatting SD cards” on page 92](#) )
- Use an SD card that is Class 10 or higher.
- Format an SD card before recording to it at 96 kHz. Without formatting first, skipping could occur when recording.

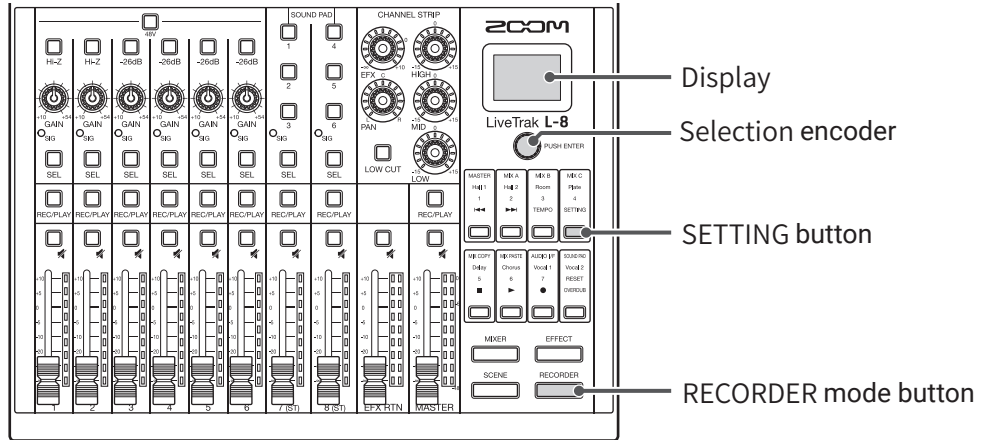

# Creating new projects

The **L-8** manages recording and playback data in units called projects.



1. Press  so that it lights.  
This opens the RECORDER screen.
2. Press  so that it lights.  
This opens the SETTING screen.
3. Use  to select **PROJECT > NEW PROJECT**.
4. Turn  to select **YES**, and press .

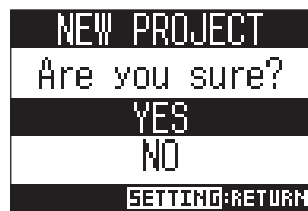

## NOTE

- See "[Projects](#)" on page 66 for information about projects.
- When a new project is created, it will start with the current mixer settings.

## HINT

When the **L-8** power is turned on, it will automatically load the last used project.

# Recording/overdubbing and playing recordings

The **L-8** has recorder functions that enable simultaneous recording of up to 12 tracks and simultaneous playback of up to 10 tracks.

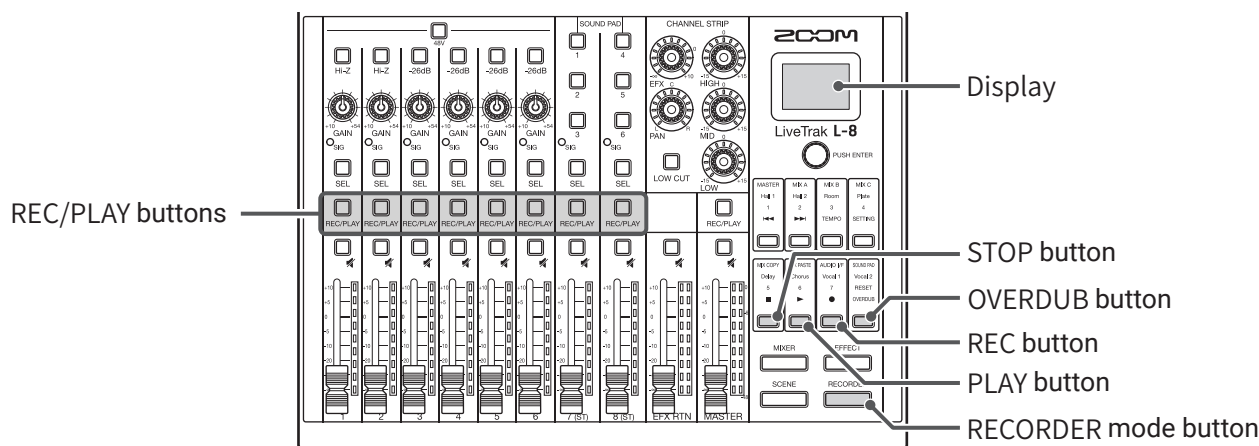

The input signals of each channel and the master fader output signal can be recorded and played.

## Recording



1. Press  so that it lights.  
This opens the RECORDER screen.

2. Use  to turn overdubbing on or off.

-  lit (on): Overwrite the current project
-  unlit (off): Create a new project and record in it

3. Press  for the channels you want to record until their buttons light red.

4. Press  to light it and start recording standby.

### HINT

If the current project already has a recorded file, and  is off, pressing  will create a new project and then start recording standby.

5. Press  to light it and start recording.

6. Press  to stop recording.

**NOTE**

- The channel 7 and 8 recording tracks are stereo.
- Punching in/out ( → [“Redoing parts of recordings \(punching in/out\)”](#) on page 45)
- Starting recording automatically ( → [“Starting recording automatically”](#) on page 48)
- Capturing audio before recording starts ( → [“Pre-recording before recording starts”](#) on page 50)
- When recording stops, “Please wait” appears on the display. Do not turn the power off or remove the SD card while this message appears. Doing so could cause data loss or malfunction.

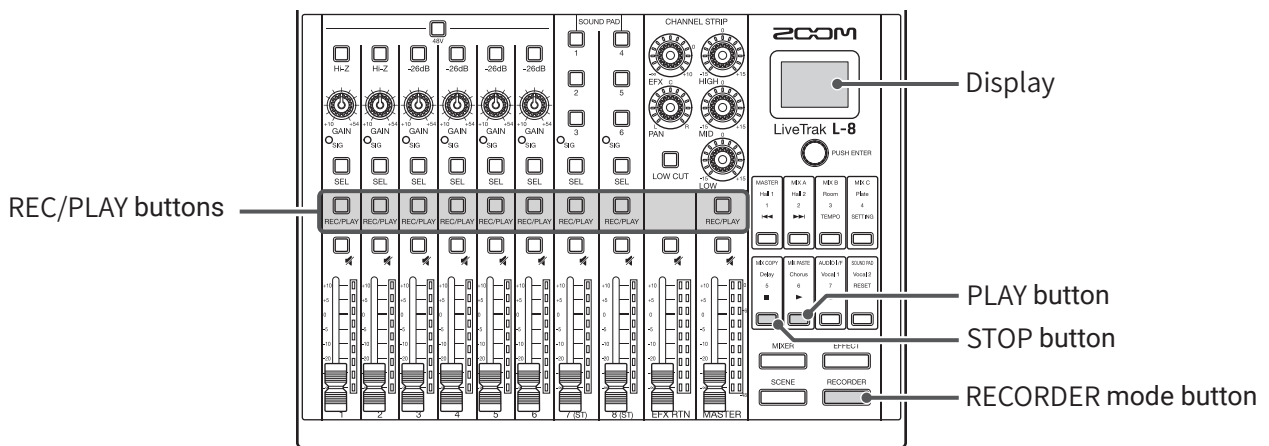

## Playing recordings



1. Press  so that it lights.  
This opens the RECORDER screen.

2. Press  for the channels you want to play until their buttons light green.

3. Press  to start playback.

-  lit: playing back
-  blinking: paused

4. Press  to stop playback.

**NOTE**



- The channel 7 and 8 playback tracks are stereo.
- Playback signals are inserted before the equalizer section, so their EQ and panning settings can be adjusted during playback. ( → [“Mixer block diagram”](#) on page 112)
- Selecting projects for playback ( → [“Selecting projects for playback”](#) on page 51)
- Changing the playback mode ( → [“Changing the playback mode”](#) on page 90)
- Other channels cannot be played back when the MASTER channel is playing back.

# Adding marks

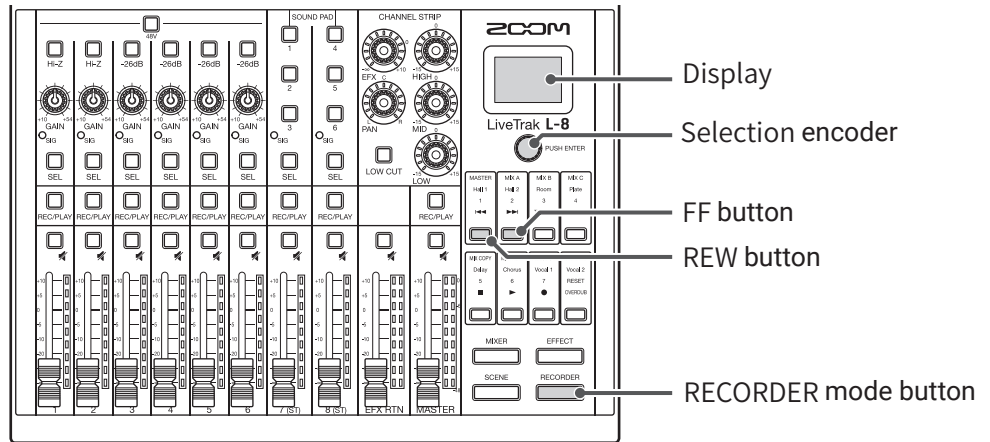

Adding marks at desired positions with the recorder makes moving to those positions easy.



## Adding marks during recording and playback

1. Press  so that it lights.  
This opens the RECORDER screen.
2. Press  during recording/playback.

## Moving in mark order

1. Press  so that it lights.  
This opens the RECORDER screen.
2. Use these buttons to move in mark order.  
Move to next mark: Press   
Move to previous mark: Press 

### NOTE

Checking and deleting marks in projects ( → [“Checking, deleting and moving to marks” on page 71](#))

### HINT

- A maximum of 99 marks can be added to one project.
- A mark can be deleted by pressing  when at the mark position.

# Redoing parts of recordings (punching in/out)

Punching in/out is a function that can be used to rerecord parts of already recorded tracks. "Punching in" is switching track status from playback to recording. "Punching out" is switching track status from recording to playback.

With the **L-8**, punching in/out can be conducted using buttons on its top.

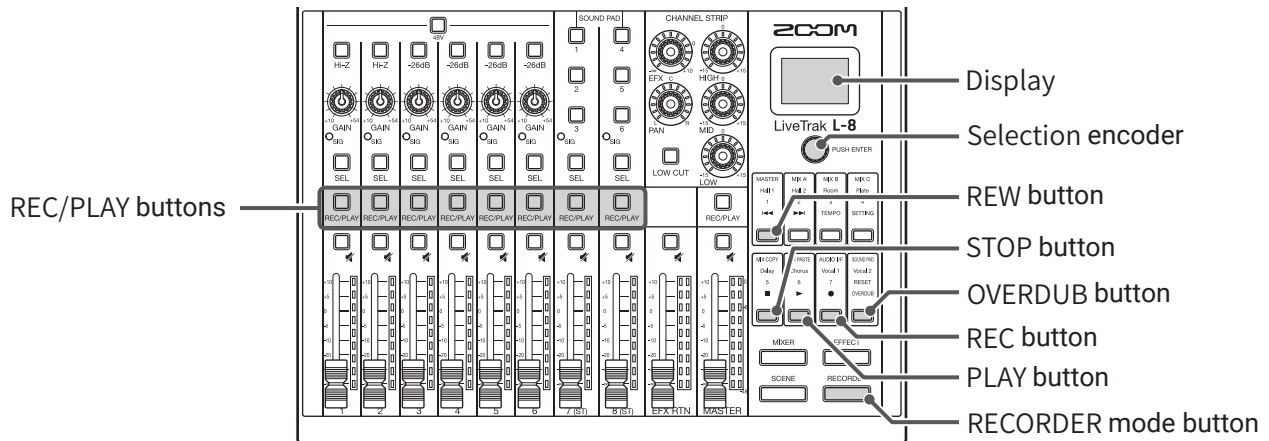

1. Press  so that it lights.  
This opens the RECORDER screen.



---

2. Press  to turn it on (lighting it).

---

3. Press  repeatedly for the channels to redo until they light red.

---

4. Press  or turn  left to move to before the part to be rerecorded.

---

5. Press  to start playback.

---

6. Press  at the position where you want to start rerecording (punch in).

---

7. Press  to end rerecording (punch out).

## NOTE

- Punching in/out overwrites recordings.
- Punching in/out can be done up to 10 times each time playback is started.

8. Press  to stop playback.

# Mixing down tracks

A final stereo mix can be recorded to the master track.

Signals are sent to the master track after passing through the master fader.

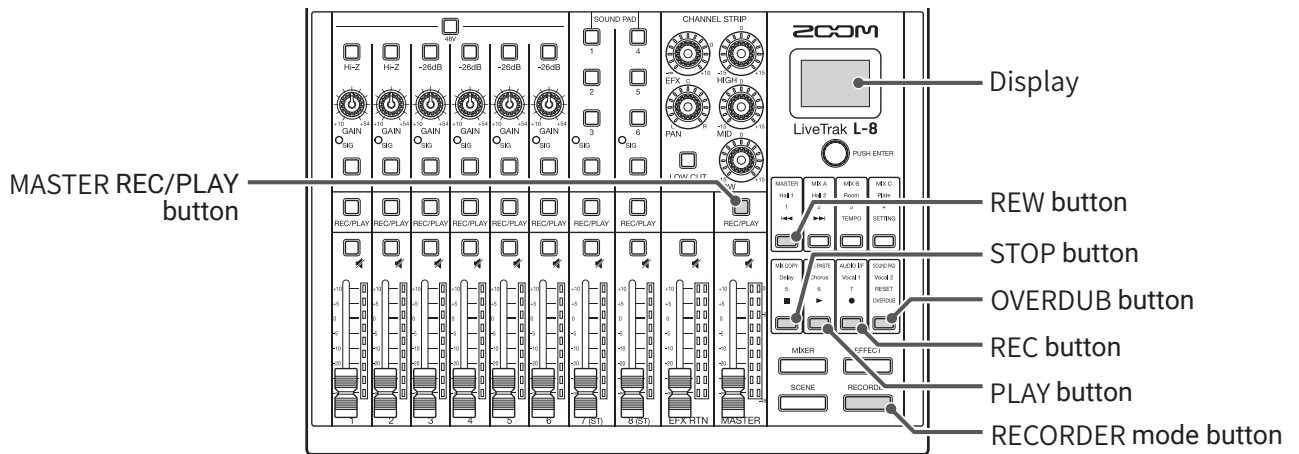

## Mixing down to the master track

1. Press  so that it lights.  
This opens the RECORDER screen.

2. Press  to turn it on (lighting it).

### NOTE

- Adjust the volume and panning of each recorded track before starting.
- When mixing down, set the sampling rate to 44.1 kHz or 48 kHz.  
If the sampling rate is 96 kHz,  cannot be set to ON.

3. Press the MASTER  repeatedly until it lights red.

4. Press  to return to the recording beginning.

5. Press  to start recording standby.

6. Press  to start recording.

7. Press  to end mixing down.

## Playing the master track

---

1. Press  so that it lights.  
This opens the RECORDER screen.

2. Press the MASTER  repeatedly until it lights green.

3. Press .

### NOTE

- To stop master track playback, press MASTER  repeatedly until it becomes unlit.
- When the master track is playing, other tracks will not be played back.
- To listen to playback of the master track through headphones connected to MONITOR OUT PHONES A–C jacks, set the MONITOR OUT A–C switches to MASTER.

# Starting recording automatically

Recording can be started and stopped automatically in response to the level after passing through the master fader.

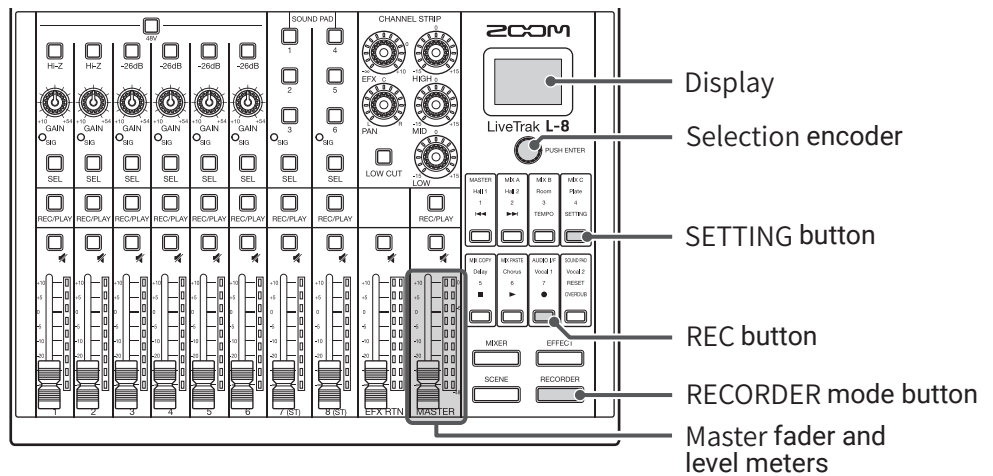

1. Press  so that it lights.  
This opens the RECORDER screen.



---

2. Press  so that it lights.  
This opens the SETTING screen.

---

3. Use  to select **REC/PLAY** > **AUTO REC** > **ON/OFF**.

---

4. Turn  to select **ON**, and press .

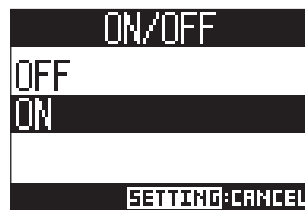

## NOTE

Making additional settings for automatic recording ( → [“Changing automatic recording settings” on page 86](#))

5. Press  repeatedly to open the RECORDER screen.

## HINT

Press  to return to the RECORDER screen.



6. Press  to light it and start recording standby.

The MASTER level meters will blink at the level that will cause automatic recording to start.

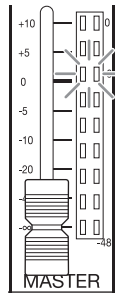

---

**HINT**

Recording starts automatically when the input exceeds the set level (shown by the MASTER level meters). Recording can be set to stop automatically when the input goes below a set level. ( → [“Setting automatic stopping” on page 87](#))

---

7. Press  to end recording standby or stop recording.

**NOTE**

- This function cannot be used with the PRE REC, METRONOME or PRE COUNT functions. When AUTO REC is turned on, these other functions will be disabled.
- When the OVERDUB function is enabled, the AUTO REC function will be disabled.

# Pre-recording before recording starts

Input signals can be captured for up to 2 seconds before recording is started (pre-recording). Setting this in advance can be useful when a performance starts suddenly, for example.

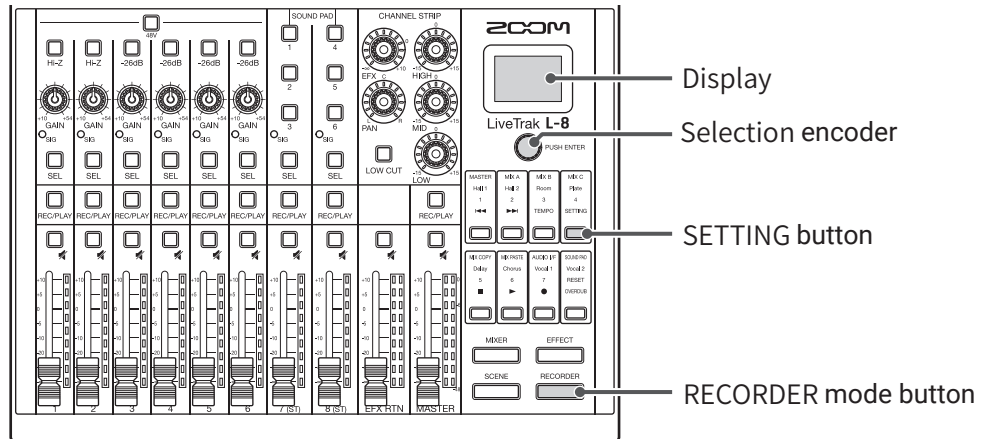

1. Press  so that it lights.  
This opens the RECORDER screen.



---

2. Press  so that it lights.  
This opens the SETTING screen.

---

3. Use  to select **REC/PLAY** > **PRE REC**.

---

4. Turn  to select **ON**, and press .







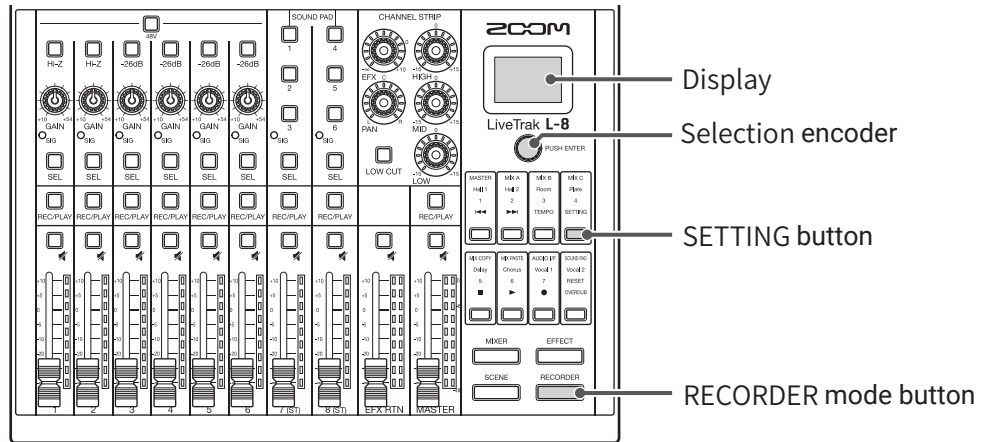

## NOTE

- This function cannot be used with the AUTO REC, METRONOME, PRE COUNT or OVERDUB functions.
- When AUTO REC or PRE COUNT is turned on, PRE REC will be disabled.
- The PRE REC function continues to be enabled even when recording is paused.

# Selecting projects for playback

Projects saved on SD cards can be loaded.



1. Press  so that it lights.  
This opens the RECORDER screen.
2. Press  so that it lights.  
This opens the SETTING screen.
3. Use  to select PROJECT > SELECT.
4. Turn  to select the project to load, and press .



## NOTE

- When a project is loaded, the mixer settings saved in that project are also loaded.
- If actual channel fader positions differ from the channel fader positions of the loaded project, the level meters will show the recalled fader positions. The volume will not be changed until the actual fader position becomes the same as the recalled position.
- When switching to a different project, the project mixer settings of the current project are saved to the settings file in the project folder.

# SOUND PAD functions

Audio files (WAV format) can be assigned to the SOUND PAD 1-6 buttons. Press one to play the assigned file. The level and playback method can be set for each pad. These are useful, for example, for playing effect sounds during podcasting and streaming as well as during live theater and music performances.

## NOTE

When the **L-8** sample rate is set to 96 kHz, the SOUND PAD function cannot be used.

## Playing sounds with SOUND PAD buttons

When shipped new from the factory, the **L-8** contains 13 sounds, 6 of which are already assigned to SOUND PAD buttons.

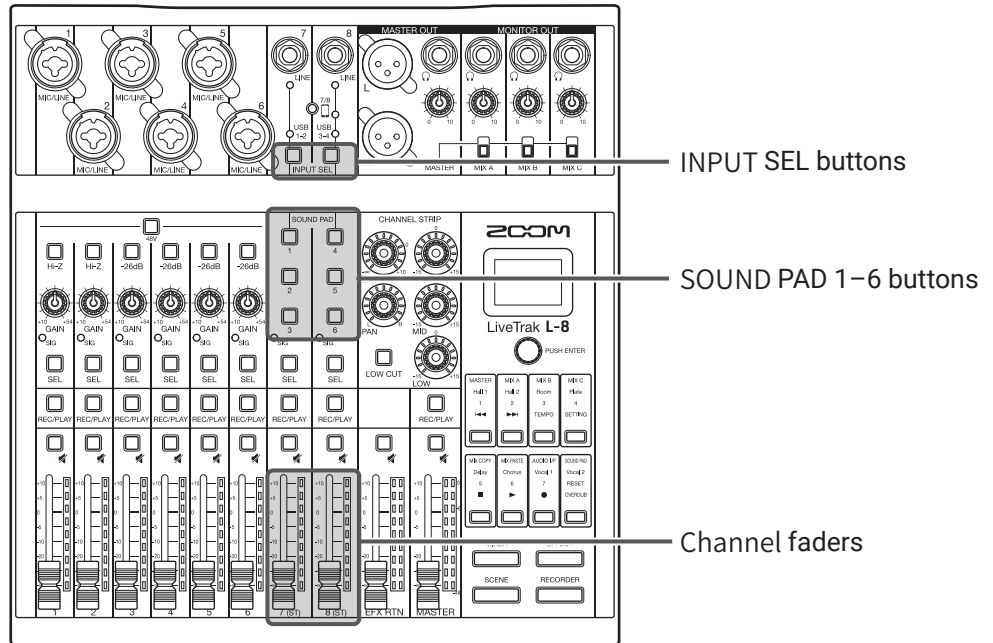

1. Press  for channel 7 or 8, to switch its input to the SOUND PAD buttons, which light if they have sounds assigned to them.
  - SOUND PAD 1, 2 and 3 are input on channel 7.
  - SOUND PAD 4, 5 and 6 are input on channel 8.

2. Press a SOUND PAD.

This plays the sound assigned to that SOUND PAD.

The volume can be adjusted using the channel 7 and 8 faders.

The audio quality can be adjusted ( → [“Adjusting the tone and panning” on page 30](#)) and an effect can be applied ( → [“Using the built-in effects” on page 31](#)) in the same way as other channels.

## NOTE

SOUND PAD playback on a channel can be stopped by pressing  4 times in a row.

# Assigning audio files to SOUND PAD buttons

Built-in sounds and audio files saved on an SD card can be assigned to SOUND PAD buttons. Moreover, the **L-8** can record sounds directly for assignment to SOUND PAD buttons. (The MASTER mix sound is recorded.)

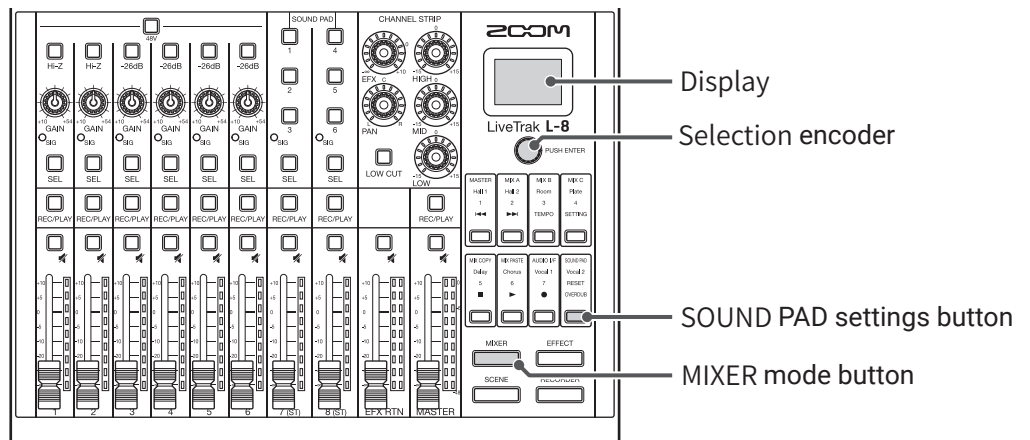

## Assigning built-in sounds and audio files stored on the SD card

### NOTE

Before assigning an audio file stored on an SD card, use a computer to store the file on the card in any directory other than the PROJECT folder.

(→ [“Card reader” on page 82](#))

The SOUND PAD function supports the following file types.



- File format: WAV
- Sample rate: 44.1/48 kHz
- Bit rate: 16/24-bit
- Channels: mono/stereo

The audio file sample rate must match the **L-8** SAMPLE RATE setting.

1. Press  so that it lights.  
This opens the MIXER screen.



2. Press  so that it lights.  
This opens the SOUND PAD screen.

3. Turn  PUSH ENTER to select the SOUND PAD (1–6) for sound file assignment, and press  PUSH ENTER.

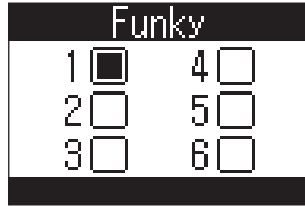

**HINT**

A SOUND PAD can also be selected for audio file assignment by pressing it.



4. Turn  PUSH ENTER to select **SOUND ASSIGN**, and press  PUSH ENTER.



5. To assign a built-in sound:

Turn  PUSH ENTER to select **PRESET SOUND**, and press  PUSH ENTER.

To assign an audio file stored on an SD card:

Turn  PUSH ENTER to select **SD CARD (WAV)**, and press  PUSH ENTER.



The built-in sound sources or the audio files stored on the SD card are shown on the list.

**NOTE**

Select **NONE** to not assign any audio file to a SOUND PAD.

6. Turn  PUSH ENTER to select the audio file to assign, and press  PUSH ENTER.

This assigns the audio file to the selected SOUND PAD.

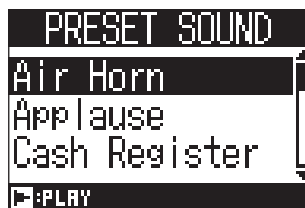



**HINT**

Audio files can be auditioned by selecting them and pressing .

## Directly recording and assigning sounds to SOUND PAD buttons

1. Press  so that it lights.  
This opens the MIXER screen.

2. Press  so that it lights.  
This opens the SOUND PAD screen.

3. Turn  to select the SOUND PAD (1–6) for sound file assignment, and press .

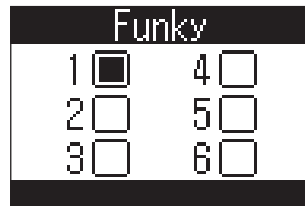

### HINT

A SOUND PAD can also be selected for audio file assignment by pressing it.

4. Turn  to select **SOUND ASSIGN**, and press .



5. Turn  to select **REC**, and press .

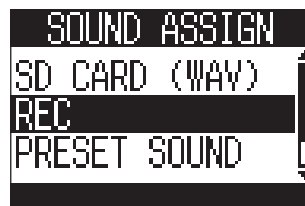

6. Press .

This starts recording. The MASTER OUT mix sound is recorded. Press it again to stop recording and assign the recorded audio file to the selected SOUND PAD.



**NOTE**

- The recorded audio file is saved to the “SOUND\_PAD” folder with a name that combines the pad number, date and a sequential number. (File name example: P1\_0101\_001.WAV)
- Up to 1000 can be saved.
- The sample rate of the audio file depends on the sample rate set on the **L-8**.
- The bit rate depends on the recording setting.
- The maximum recording length is 2 hours.
- During recording, the PRE REC, AUTO REC, METRONOME and LATENCY ADJUST settings are not applied.

---

**HINT**

During recording, all SOUND PAD buttons can be used to play their sounds.

---



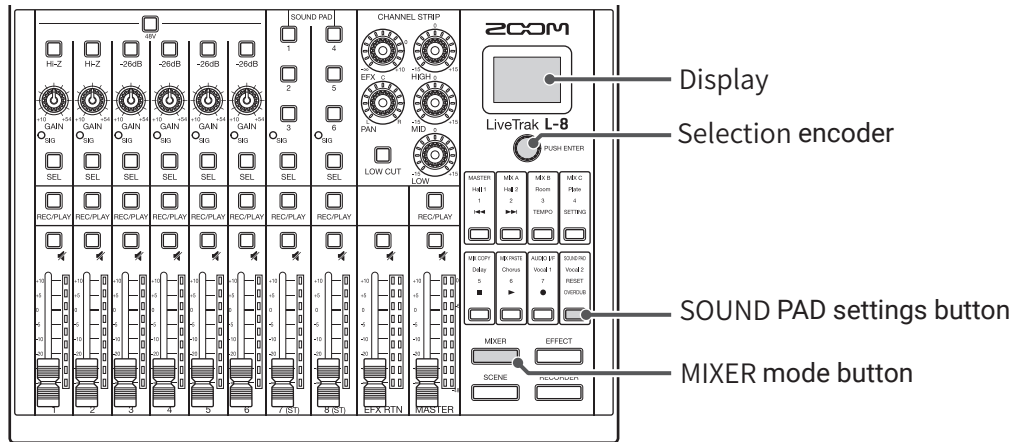

# Changing SOUND PAD playback methods

For each SOUND PAD, the sound playback method used when it is pressed can be changed.



1. Press  so that it lights.  
This opens the MIXER screen.

2. Press  so that it lights.  
This opens the SOUND PAD screen.

3. Turn  to select the SOUND PAD (1-6) for playback method setting, and press .

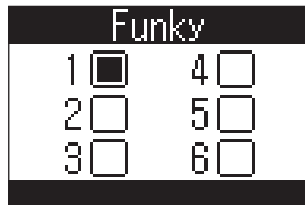



## HINT

A SOUND PAD can also be selected for playback method setting by pressing it.

4. Turn  to select **PLAY MODE**, and press .



5. Turn  to select the playback method, and press .





Setting	Explanation
ONE SHOT	Press the SOUND PAD to play the file once to its end and then stop. Press the SOUND PAD during playback to restart playback from the beginning.
LOOP	Pressing the pad alternately starts and stops playback. Loop playback will continue until stopped.
HOLD	Loop playback will continue while the SOUND PAD is being pressed. Playback will stop when it is released.

# Changing SOUND PAD playback levels

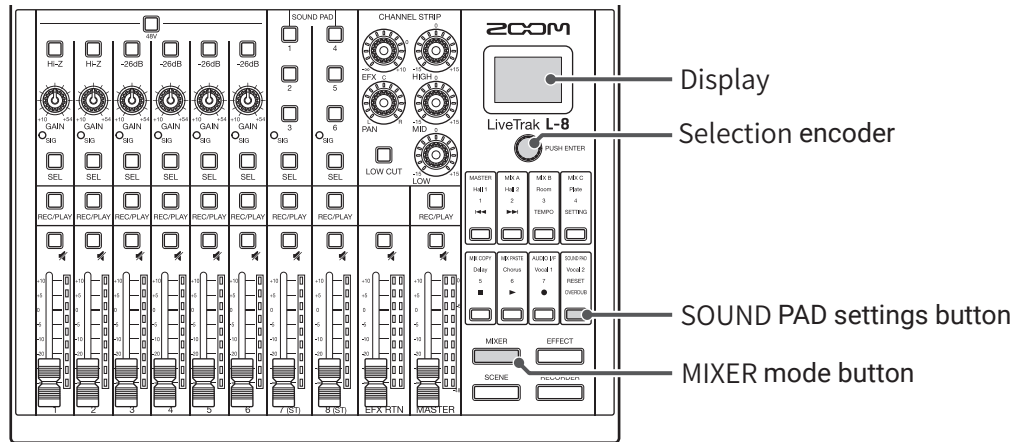
For each SOUND PAD, volume levels used when it is pressed can be changed.



1. Press  so that it lights.  
This opens the MIXER screen.

2. Press  so that it lights.  
This opens the SOUND PAD screen.

3. Turn  to select a SOUND PAD (1-6) for volume level adjustment, and press .

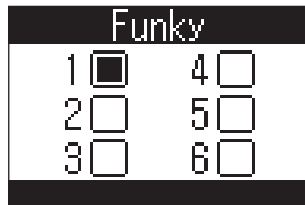



## HINT

A SOUND PAD can also be selected for volume level adjustment by pressing it.

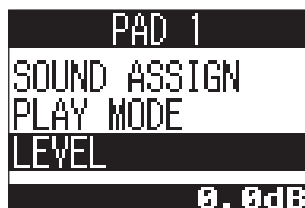
4. Turn  to select **LEVEL**, and press .



5. Turn  PUSH ENTER to adjust the volume, and press  PUSH ENTER.

The audio level can be set to  $-\infty$  or in a range from  $-48.0$  to  $+10.0$  dB (in 0.5dB increments).



# Metronome

The **L-8** metronome has adjustable volume, a selectable sound, and a precount function. The volume can also be adjusted separately for each output. Metronome settings are saved separately with each project.

## Enabling the metronome

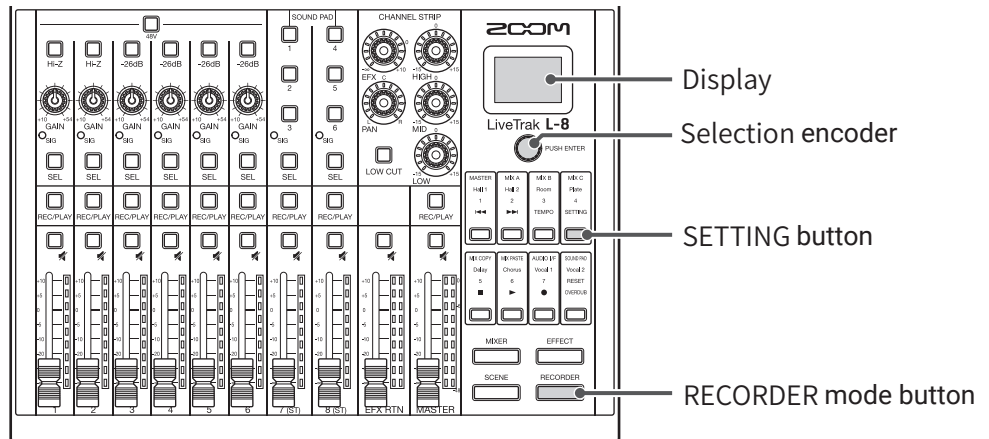

1. Press  so that it lights.  
This opens the RECORDER screen.



---

2. Press  so that it lights.  
This opens the SETTING screen.

---

3. Use  to select **METRONOME** > **CLICK**.

---

4. Turn  to select when the metronome makes sound, and press .



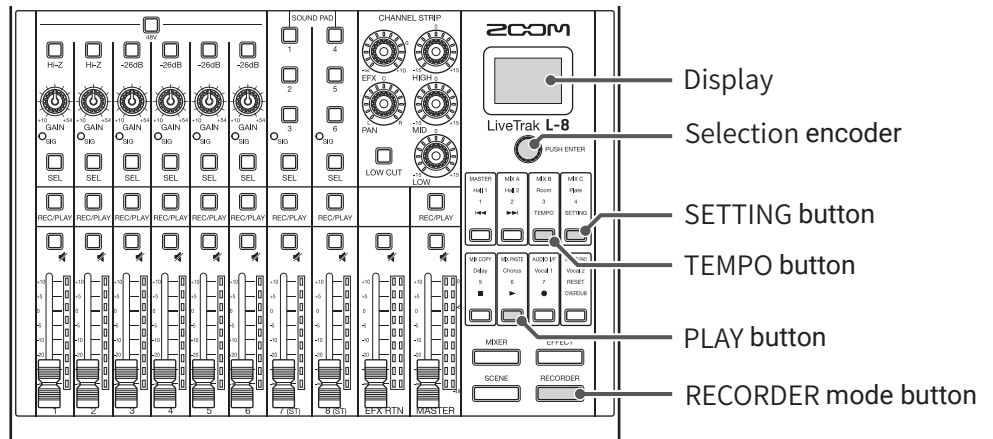

Setting	Explanation
OFF	The metronome does not make sound.
REC AND PLAY	The metronome sounds during recording and playback.
REC ONLY	The metronome sounds only during recording.
PLAY ONLY	The metronome sounds only during playback.

# Changing metronome settings





## Changing the metronome tempo

1. Press  so that it lights.  
This opens the RECORDER screen.

2. Press  so that it lights.  
The current tempo is shown on the display.

3. Do one of the following to change the tempo.

- Turn  PUSH ENTER
- Press  repeatedly at the tempo you want to set



## Setting the precount

A metronome count can be sounded before starting recording/playback.

1. Press  so that it lights.  
This opens the RECORDER screen.

2. Press  so that it lights.  
This opens the SETTING screen.

3. Use  to select METRONOME > PRE COUNT.

4. Turn  to select the precount behavior, and press .

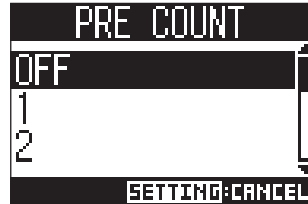

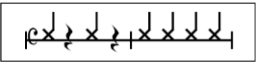

Setting	Explanation
OFF	No precount will sound.
1-8	Before recording/playback, the precount will sound for the set number of times (1-8).
SPECIAL	Before recording/playback, the precount will sound as shown below. 

#### NOTE



- The precount is enabled even during playback.
- This function cannot be used with the AUTO REC function. When AUTO REC is turned on, PRE COUNT will be disabled.
- This function cannot be used with the PRE REC function. When PRE COUNT is turned on, PRE REC will be disabled.

## Changing the metronome sound

1. Press  so that it lights.  
This opens the RECORDER screen.

2. Press  so that it lights.  
This opens the SETTING screen.

3. Use  to select METRONOME > SOUND.

4. Turn  to select the tone, and press .



---

**HINT**

The options are BELL, CLICK, STICK, COWBELL and HI-Q.

---





**NOTE**

Use  to play the metronome and check the sound.

---

## Changing the metronome pattern

---

1. Press  so that it lights.  
This opens the RECORDER screen.
2. Press  so that it lights.  
This opens the SETTING screen.
3. Use  to select METRONOME > PATTERN.
4. Turn  to select the pattern, and press .



---

**HINT**

The options are 1/4–8/4 and 6/8.

---

**NOTE**



Press  to play the metronome and check the pattern.

---

## Changing the metronome volume

---



The metronome volume can be adjusted separately for the MASTER OUT and the MONITOR OUT A–C outputs.

1. Press  so that it lights.  
This opens the RECORDER screen.
  2. Press  so that it lights.  
This opens the SETTING screen.
-



3. Use  to select METRONOME > LEVEL > MASTER or MONITOR OUT A-C.

---

4. Turn  to adjust the volume, and press .



---

**HINT**

Set from 0 to 100.

---

**NOTE**

Press  to play the metronome and check the volume.

# Projects

The **L-8** manages recording and playback data in units called projects.

The following data is saved in projects.

- Audio data
- Mixer settings
- Send return effect settings
- Mark information
- Metronome settings

## Changing project names

The name of the currently loaded project can be changed.

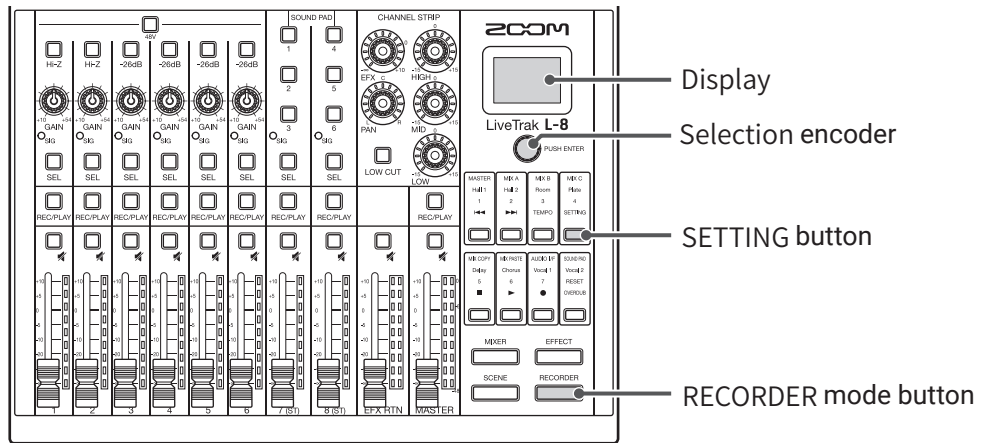

1. Press  so that it lights.  
This opens the RECORDER screen.

---

2. Press  so that it lights.  
This opens the SETTING screen.



---

3. Use  to select **PROJECT > RENAME**.

---

4. Edit the name.



- Move cursor or change character: Turn 
- Select character to change/confirm change: Press 

#### NOTE

- The default project name is the date and time of creation. For example, if a project was created at 6:48:20 p.m. on Thursday, March 14, 2019, the project name would be "190314\_184820" (YYMMDD\_HHMMSS).
- Project names have 13 characters.
- The following characters can be used in project and file names.  
(space) ! # \$ % & ' ( ) + , - 0 1 2 3 4 5 6 7 8 9 ; = @  
A B C D E F G H I J K L M N O P Q R S T U V W X Y Z [ ] ^ \_ `   
a b c d e f g h i j k l m n o p q r s t u v w x y z { ~ }
- Projects can be ordered numerically or alphabetically.
- Project/file names cannot be only spaces.
- The project name is the same as the project folder name on the SD card.





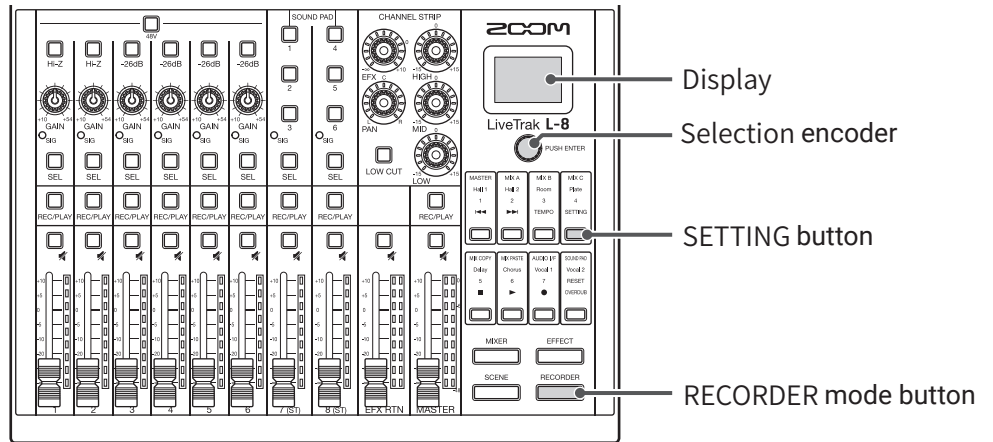

---

5. Turn  PUSH ENTER to select **OK**, and press  PUSH ENTER.

# Deleting projects

Projects inside the selected folder can be deleted.



1. Press  so that it lights.  
This opens the RECORDER screen.
2. Press  so that it lights.  
This opens the SETTING screen.
3. Use  to select **PROJECT > DELETE**.
4. Turn  to select the project you want to delete, and press .
5. Turn  to select **YES**, and press .





## NOTE

Projects cannot be deleted if protection is ON.

# Protecting projects

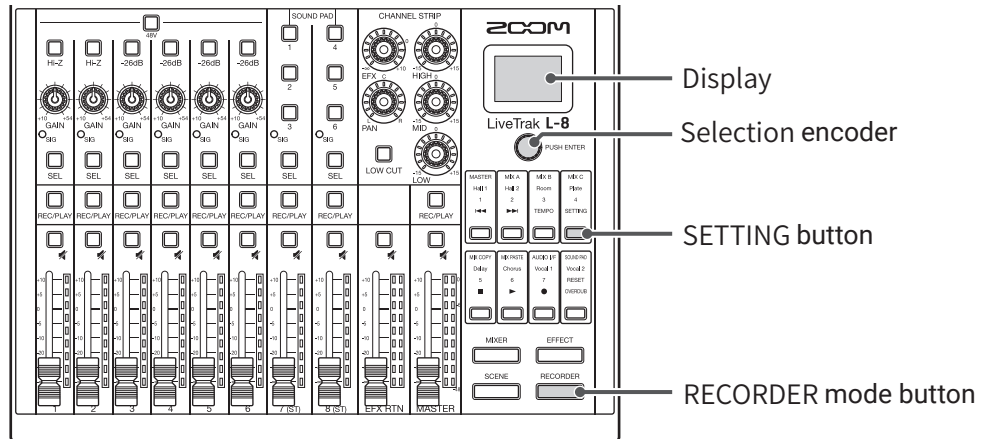
The currently loaded project can be write-protected, preventing the project from being saved, deleted or having its content changed.



1. Press  so that it lights.  
This opens the RECORDER screen.



---

2. Press  so that it lights.  
This opens the SETTING screen.

---

3. Use  to select **PROJECT > PROTECT**.

---

4. Turn  to select **ON**, and press .





## NOTE

- Projects cannot be used for recording if protection is ON. Turn protection OFF to record.
- When protection is OFF for a project, it will always be saved to the SD card when the power is turned off or another project is loaded. We recommend turning protection ON to prevent accidentally saving changes to a musical project after it has been completed.

# Checking project information

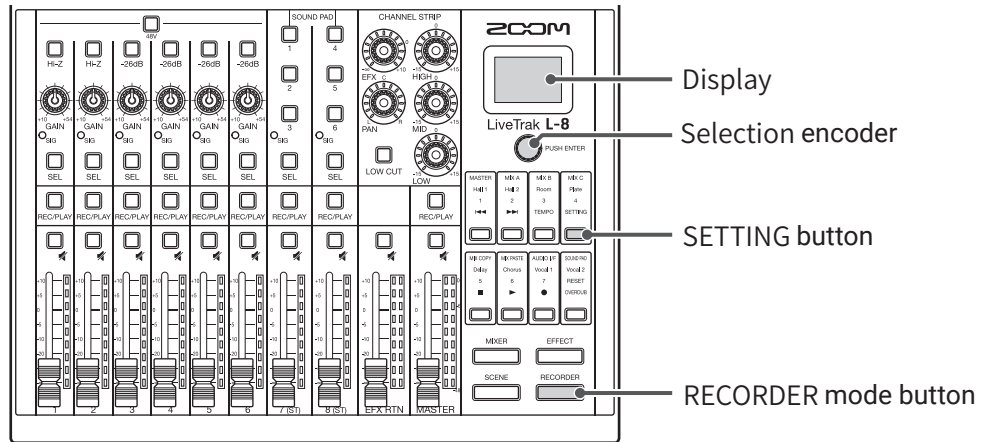
Various information about the currently loaded project can be viewed.



**1.** Press  so that it lights.  
This opens the RECORDER screen.

**2.** Press  so that it lights.  
This opens the SETTING screen.

**3.** Use  to select **PROJECT**.

**4.** Turn  to select **INFORMATION**, and press .





Item shown	Explanation
NAME	Project name
DATE	Project creation date (YYYY/MM/DD HH:MM:SS)
FMT	Recording format
SIZE	Project size
TIME	Project length (HHH:MM:SS)
FILE	Information about tracks and files

# Checking, deleting and moving to marks

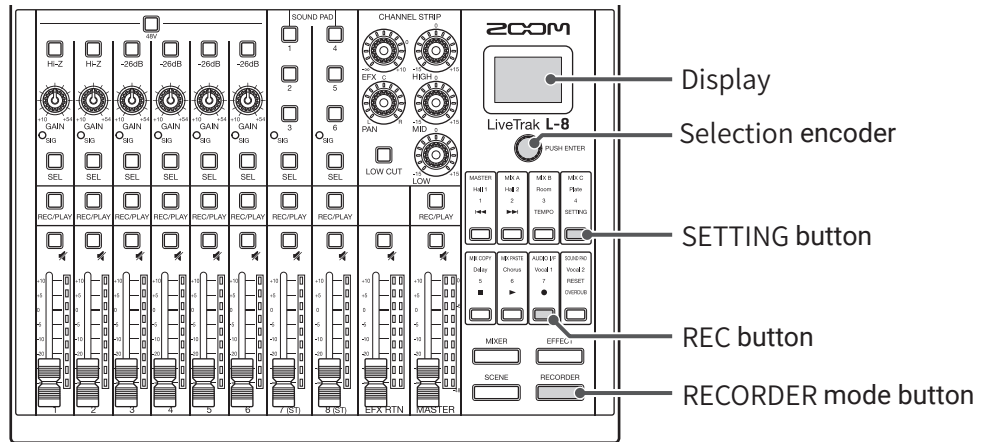
A list of marks in the currently loaded project can be opened, allowing them to be checked, moved to and deleted.





**1.** Press  so that it lights.  
This opens the RECORDER screen.

**2.** Press  so that it lights.  
This opens the SETTING screen.

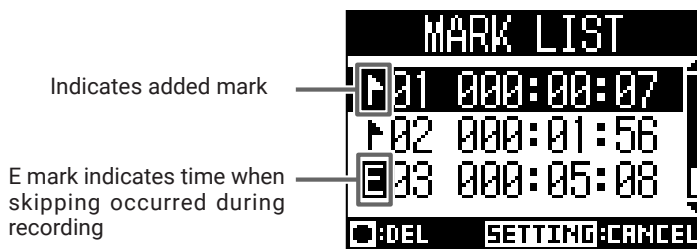
**3.** Use  to select **PROJECT > MARK LIST**.  
A list of marks appears.



**4.** Select a mark and move to or delete it.

- Select a mark: Turn 
- Move to a mark: Press 
- Delete a mark: Press 

# Audio files

The **L-8** creates the following types of audio files according to the recording channel.

- Channels 1–6: mono WAV files
- Channels 7, 8 and MASTER: stereo WAV files

The file format depends on the sampling rate ( → [“Changing the sampling rate” on page 97](#)) and quantization bit depth ( → [“Changing the recording format” on page 85](#)) used by the unit.

The **L-8** can also play audio files created using DAW software ( → [“Assigning audio files to tracks” on page 74](#)).

## NOTE

- The names given to audio files depend on their channels.
  - Channels 1–6: TRACK01–TRACK06
  - Channels 7–8: TRACK07\_ST, TRACK08\_ST
  - MASTER: MASTER
- If the file size exceeds 2 GB during recording, a new file will be created automatically in the same project and recording will continue without pause. When this happens, numbers like “\_01” and “\_02” will be added to the ends of the file names.

## Deleting audio files

Audio files that are not needed can be deleted.

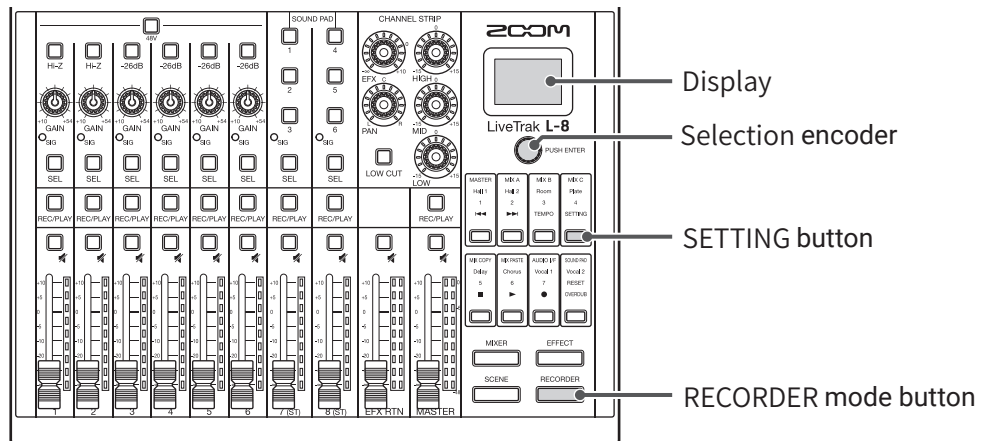



1. Press  so that it lights.  
This opens the RECORDER screen.

2. Press  so that it lights.  
This opens the SETTING screen.

3. Use  to select **PROJECT > FILE DELETE**.



4. Turn  to select the file to delete, and press .

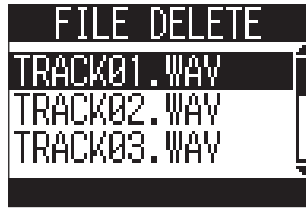

5. Turn  to select YES, and press .



**NOTE**

Audio files cannot be deleted if protection is ON for their projects.

# Assigning audio files to tracks

Audio files can be imported from projects or elsewhere to existing projects and assigned to channels.

## NOTE

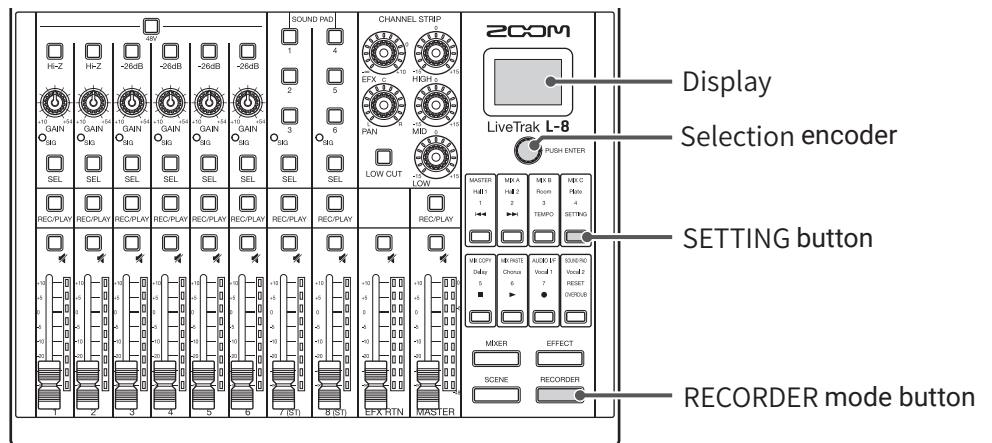

- To load audio files from an SD card, first use a computer to store the files on the card in any directory other than the PROJECT folder. ( → [“Card reader” on page 82](#))  
The following audio file types are supported.
  - File format: WAV
  - Sample rate: 44.1/48/96 kHz
  - Bit rate: 16/24-bit
  - Channels: Mono/stereo
- The sample rate of the audio files must match the sample rate of the project.
- Channels 1–6 can have mono files assigned to them. The 7, 8 and MASTER channels can have stereo files assigned to them.
- Audio files cannot be assigned if protection is ON for their projects.



**1.** Press  so that it lights.  
This opens the RECORDER screen.



**2.** Press  so that it lights.  
This opens the SETTING screen.

**3.** Use  to select **PROJECT > TRACK ASSIGN**.

4. Use  to select the file to assign, and press .





- To assign from a project: select **PROJECT** > the project that has the file to assign
- To assign a file from the SD card: select **SD CARD (WAV)**

5. Turn  to select the file to assign, and press .



#### HINT

Audio files can be auditioned by selecting them and pressing .

6. Turn  to select the channel where the file is to be assigned, and press .

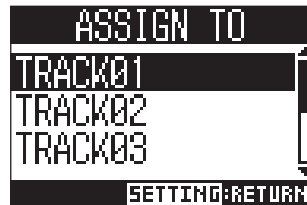

#### NOTE

- Only mono WAV files can be assigned to the 1–6 channels and only stereo WAV files can be assigned to the 7, 8 and MASTER channels.
- Files cannot be assigned to channels that already have files assigned to them.
- When files are assigned, their file names will automatically be changed according to their assigned channels.

# Audio interface

---

The **L-8** can be used as a 12-in/4-out USB audio interface. Each input channel signal is always output to the corresponding USB audio channel before the low-cut filter and equalizer are applied. Channels 1–8 and the stereo signal output from the master fader are sent to the computer (12 channels total).

## NOTE

Audio interface functions cannot be used when the sampling rate is set to 96 kHz.

## Installing the driver

1. Download the "ZOOM L-8 Driver" from [zoomcorp.com](http://zoomcorp.com) to the computer.

## NOTE

- The latest "ZOOM L-8 Driver" can be downloaded from the above website.
- Download the driver for the operating system that you are using.

- 
2. Launch the installer and install the driver.

Follow the instructions that appear on screen to install the ZOOM L-8 Driver.

## NOTE

See the Installation Guide included in the driver package for detailed installation procedures.

# Connecting to a computer

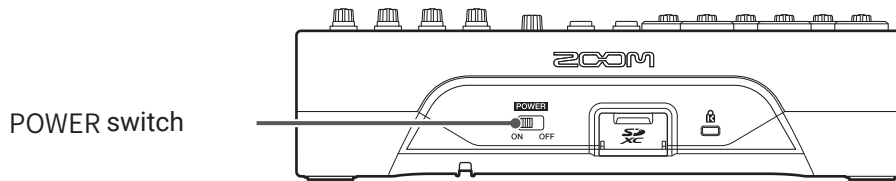
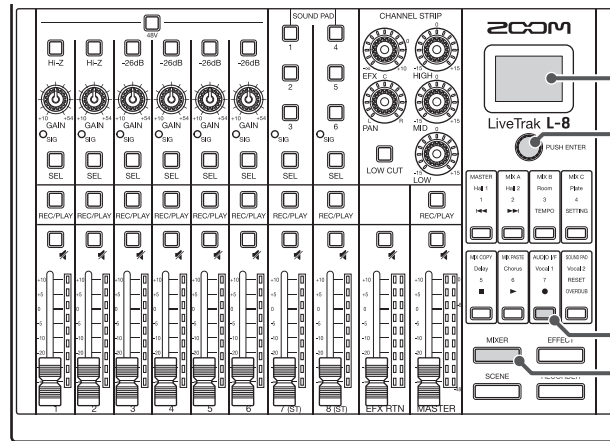

1. Use a USB cable to connect the Micro USB port to a computer.

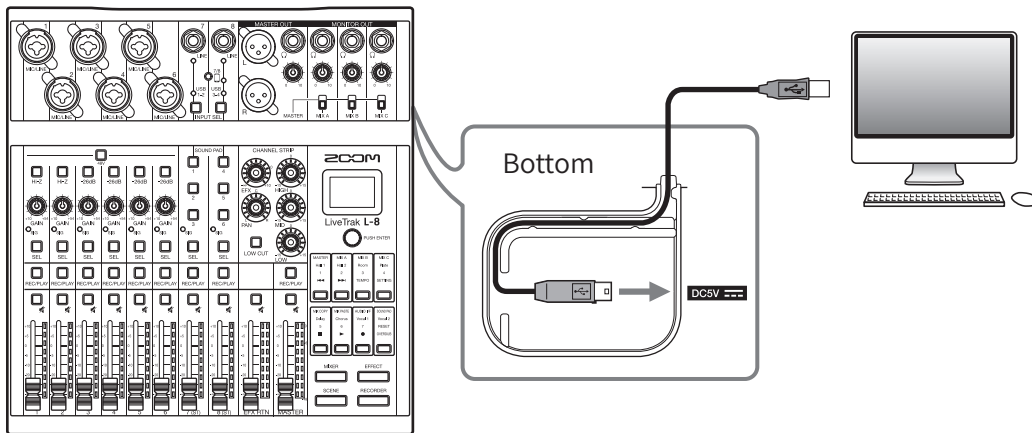

2. Set  to ON.

3. Press  so that it lights.  
This opens the MIXER screen.

4. Press  so that it lights.  
This opens the AUDIO I/F screen.



5. Turn  PUSH ENTER to select **PC/Mac**, and press  PUSH ENTER.



Setting	Explanation
PC/Mac	Select this when connected to a Windows PC or Mac.
iOS	Select this when connected to an iOS device or other type of class-compliant device.

**NOTE**

PC/Mac will be selected when the power is turned on. This setting is not saved.

6. Turn  PUSH ENTER to select YES, and press  PUSH ENTER.

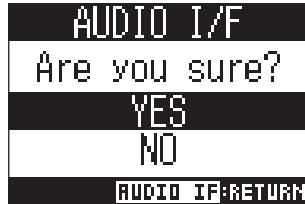



7. Select the **L-8** as the input and output device on the connected computer.

**NOTE**

The USB input signals will be shown in order on the computer as MASTER L, MASTER R, CH1, CH2... CH7 L, CH7 R, CH8 L and CH8 R.

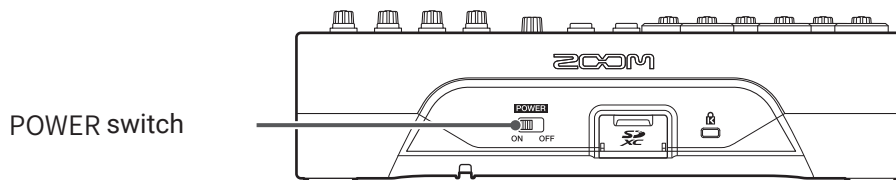
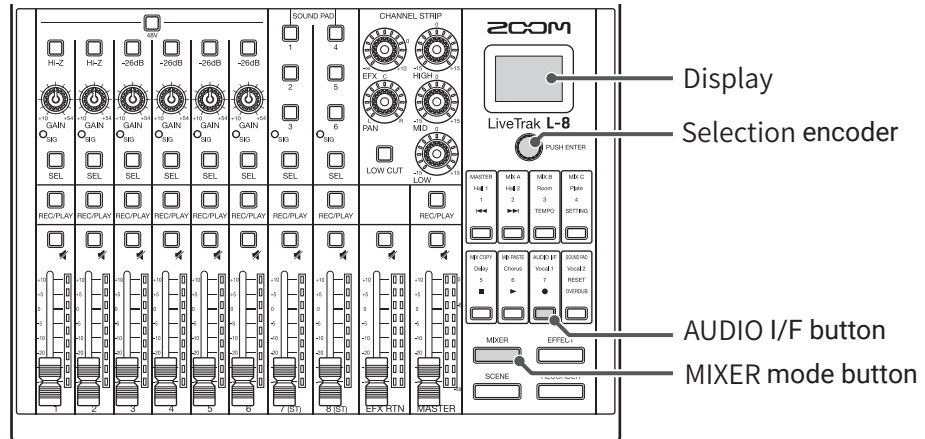
# Connecting to an iOS device



1. Set  to ON.



---

2. Press  so that it lights.  
This opens the MIXER screen.

---

3. Press  so that it lights.  
This opens the AUDIO I/F screen.

---

4. Turn  to select **iOS**, and press .



Setting	Explanation
PC/Mac	Select this when connected to a Windows PC or Mac.
iOS	Select this when connected to an iOS device or other type of class-compliant device.

## NOTE

PC/Mac will be selected when the power is turned on. This setting is not saved.

5. Turn  PUSH ENTER to select YES, and press  PUSH ENTER.

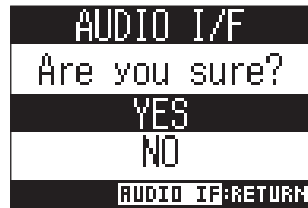

6. Use a USB cable to connect the iOS device to the Micro USB port.

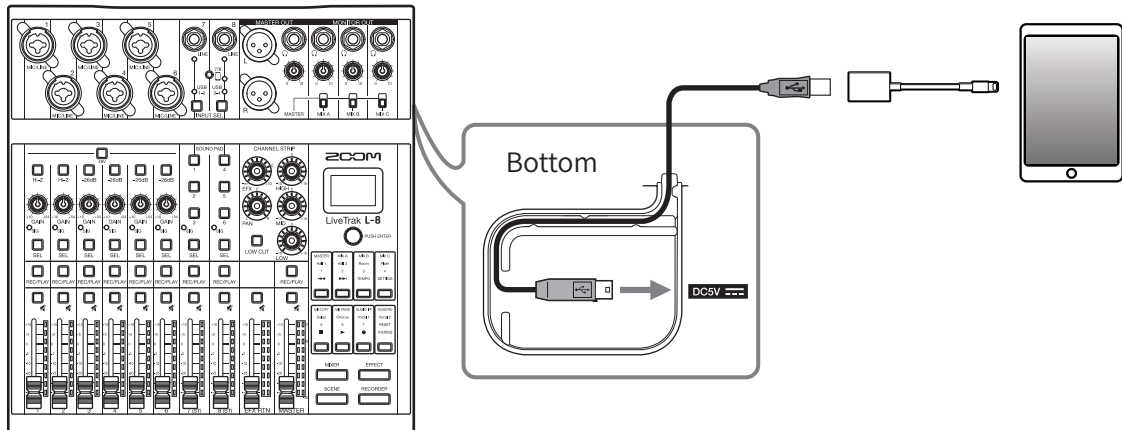

**NOTE**

When connecting to an iOS device, use a Lightning to USB camera adapter (or Lightning to USB 3 camera adapter).

7. Select the **L-8** as the input and output device on the connected iOS device.

**NOTE**

The USB input signals will be shown in order on the iOS device as MASTER L, MASTER R, CH1, CH2... CH7 L, CH7 R, CH8 L and CH8 R.



# Inputting return signals from the computer on channels 7/8

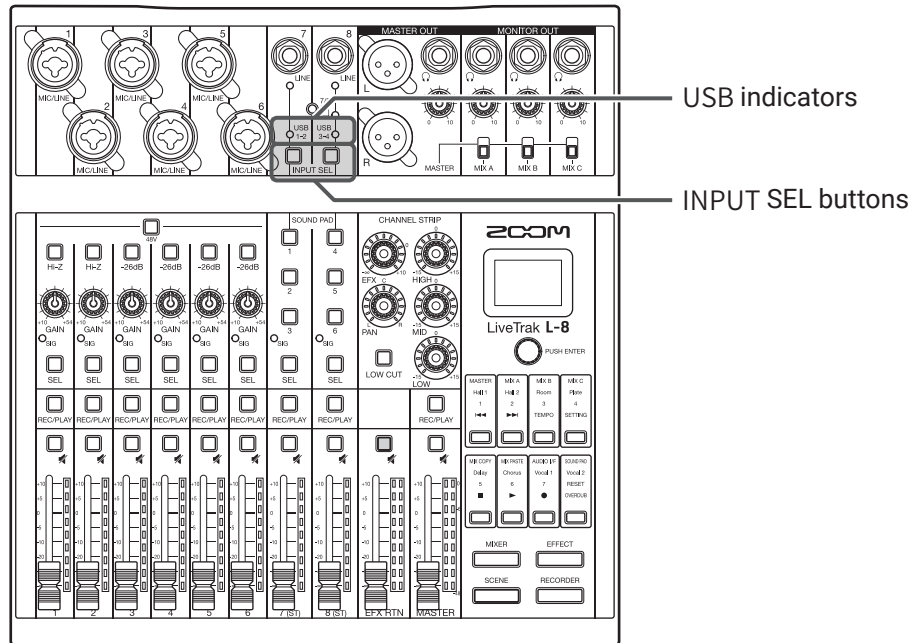

1. Press  on the channel used for input, lighting  USB 1-2 or  USB 3-4.

The signal input on the channel is switched to the USB audio channel signal (before EQ).

# Card reader

## SD card folder structure

The folder structure on SD cards used by the **L-8** is as follows.

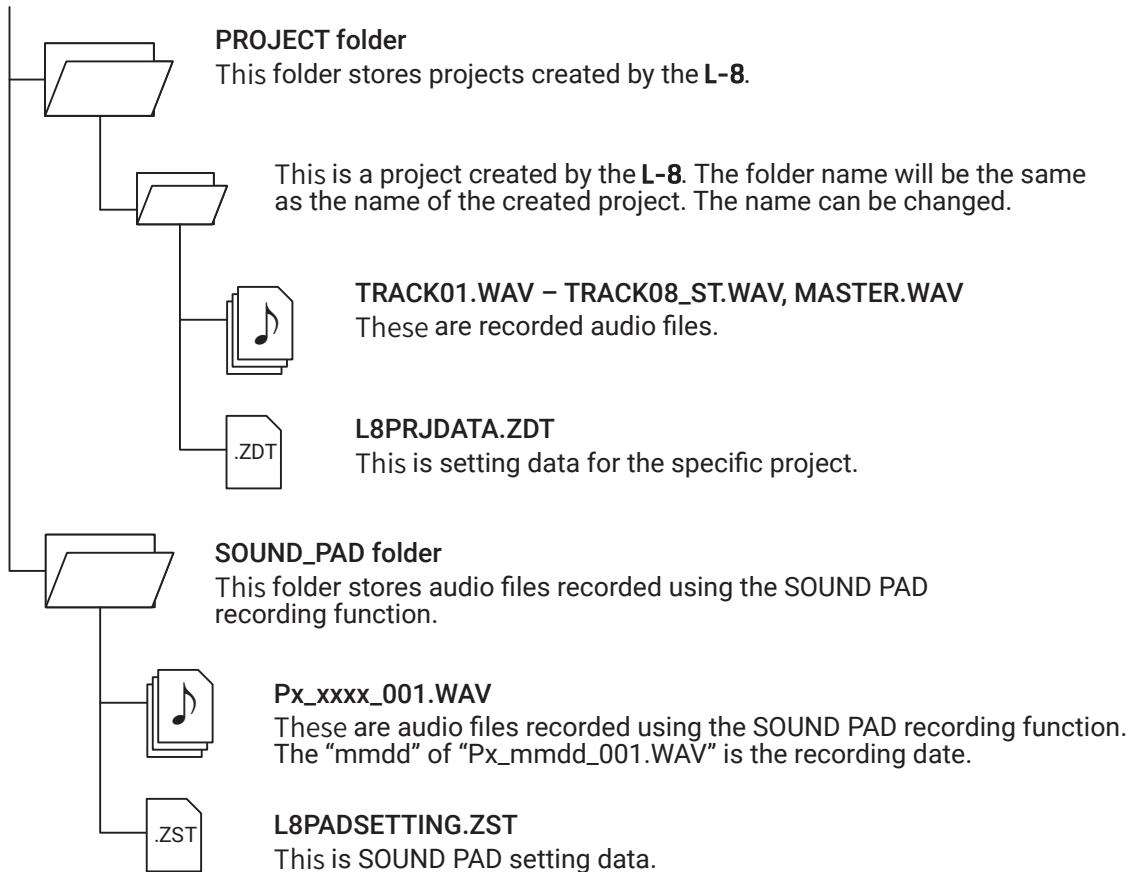

### NOTE

To assign audio files from an SD card to SOUND PAD buttons and tracks, save them somewhere outside the PROJECT folder.

# Using card reader functions

When connected to a computer, data on the SD card can be checked and copied.

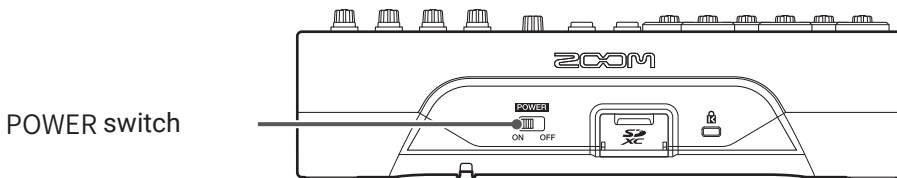
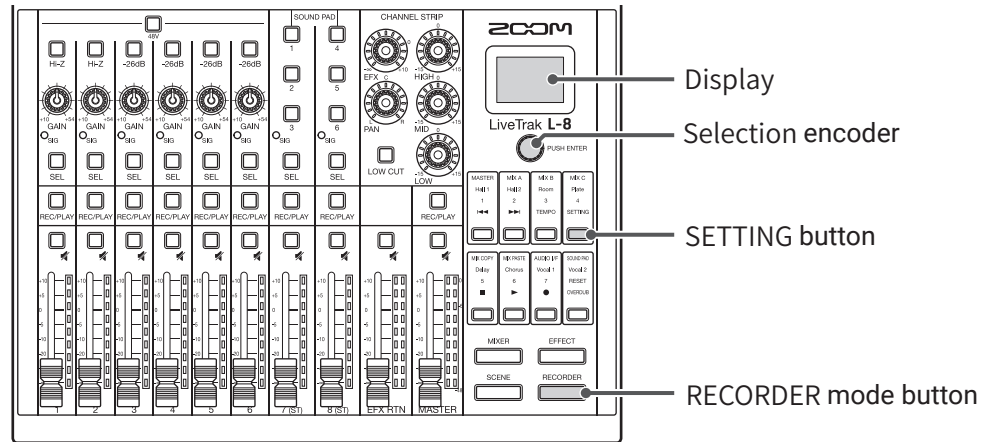

1. Use a USB cable to connect the Micro USB port to a computer.

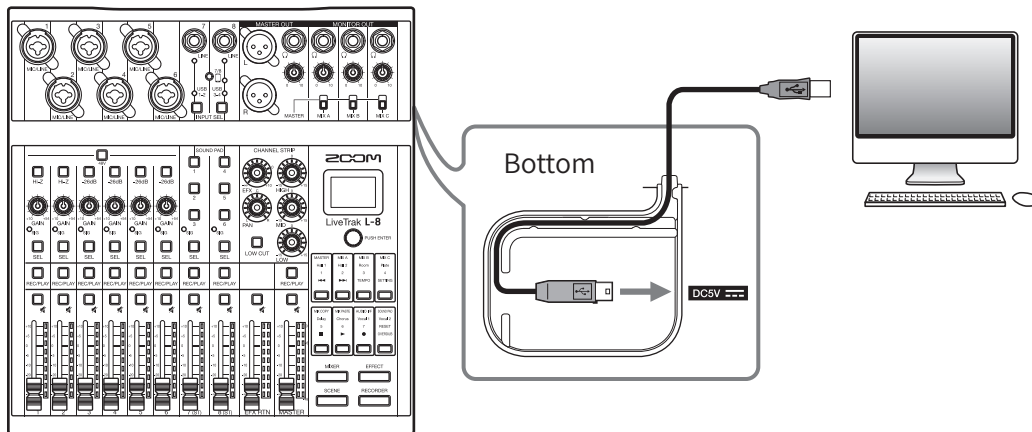

2. Set **POWER** to ON.

3. Press **RECORDER** so that it lights.  
This opens the RECORDER screen.

4. Press **SETTING** so that it lights.  
This opens the SETTING screen.

5. Use **PUSH ENTER** to select **SD CARD** > **CARD READER**.

6. Turn  PUSH ENTER to select YES, and press  PUSH ENTER.

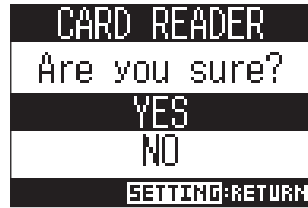

**NOTE**





When operating as a CARD READER, other functions and buttons cannot be used.

# Recording and playback settings

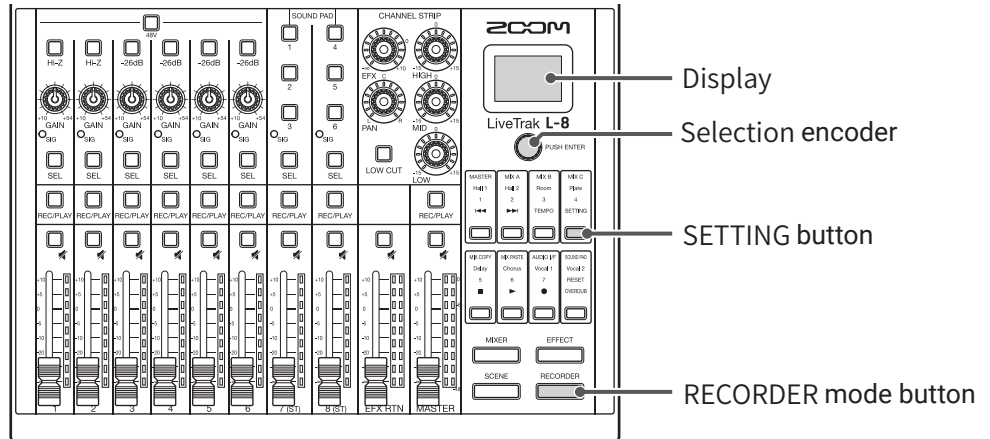
## Changing the recording format

The recording format can be changed in consideration of audio quality and file size.



1. Press  so that it lights.  
This opens the RECORDER screen.
2. Press  so that it lights.  
This opens the SETTING screen.
3. Use  to open REC/PLAY > REC FORMAT.
4. Turn  to change the format, and press .



### HINT



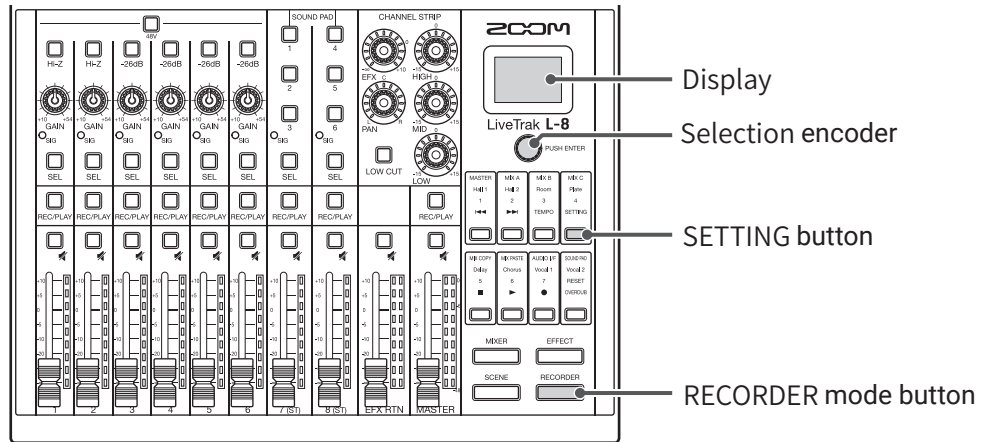

When overwriting a recording, recording will occur at the bit depth of the original file. For example, a file recorded at 16-bit cannot be overwritten with 24-bit recording.

# Changing automatic recording settings

The conditions for automatically starting and stopping recording can be set.



## Setting the automatic recording start level

1. Press  so that it lights.  
This opens the RECORDER screen.
2. Press  so that it lights.  
This opens the SETTING screen.
3. Use  to open **REC/PLAY** > **AUTO REC** > **START LEVEL**.
4. Turn  to adjust the start level, and press .

Recording will start automatically when the level of the MASTER fader output signal exceeds the set level.



### HINT



This can be set from -48 to 0 dB.

## Setting automatic stopping

1. Press  so that it lights.  
This opens the RECORDER screen.

2. Press  so that it lights.  
This opens the SETTING screen.

3. Use  to open **REC/PLAY** > **AUTO REC** > **AUTO STOP**.



4. Turn  to select the automatic stopping time, and press .



### HINT

This can be set to OFF or between 0 and 5 seconds.

5. Turn  to select **STOP LEVEL**, and press .

6. Turn  to set the stop level, and press .



Recording will stop automatically when the level of the MASTER fader output stays below the set level for the amount of time set in step 4.

### NOTE

If you start recording after setting automatic recording starting and stopping, the level set in step 6 will be shown on the MASTER level meters.

# Showing recording levels on level meters

The levels of signals recorded to the recorder can be shown on the level meters of each channel.

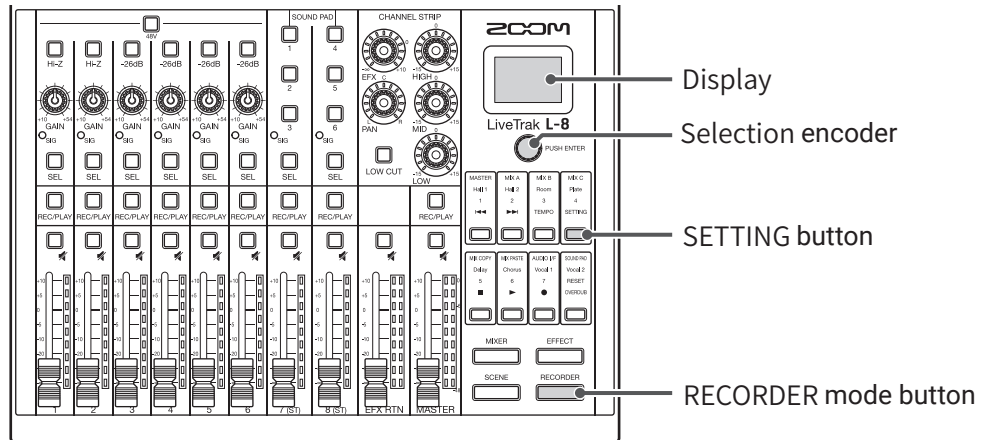

1. Press  so that it lights.  
This opens the RECORDER screen.



---

2. Press  so that it lights.  
This opens the SETTING screen.

---

3. Use  to open REC/PLAY > REC LV METER.

---

4. Turn  to select ON, and press .



If recorded signal levels are higher than post fader levels, the recorded signal levels are shown lit dimly on the level meters.





# Compensating for latency during input and output

The **L-8** can compensate for latency that occurs during input and output if you want to listen to its output signal while overdubbing.

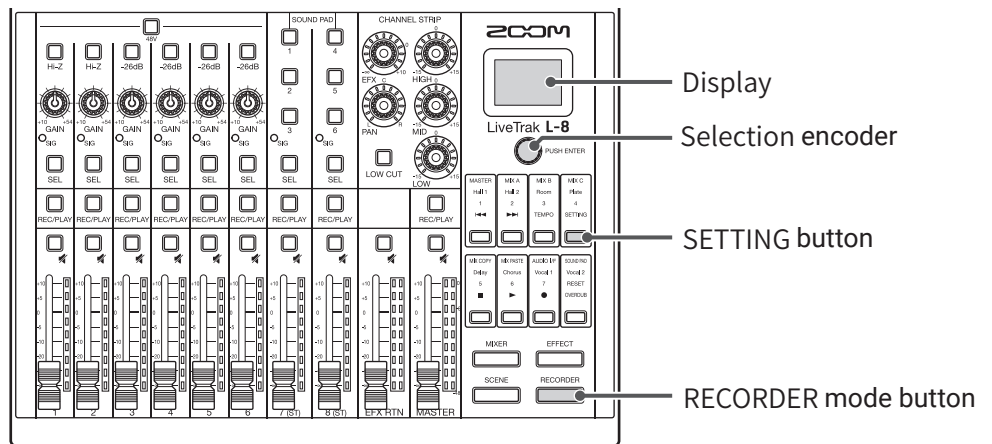
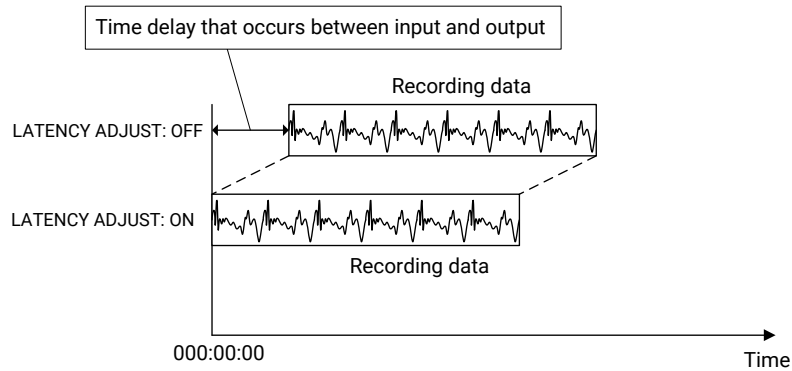

Use this menu item to set whether the latency that occurs during input and output is automatically compensated for or not when OVERDUB is ON. When automatic compensation is enabled, the recording data is shifted by the amount of latency that occurs during input and output.



1. Press  so that it lights.  
This opens the RECORDER screen.

2. Press  so that it lights.  
This opens the SETTING screen.

3. Use  to open **REC/PLAY** > **LATENCY ADJUST**.

4. Turn  to select **ON**, and press .

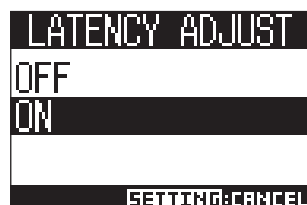

# Changing the playback mode

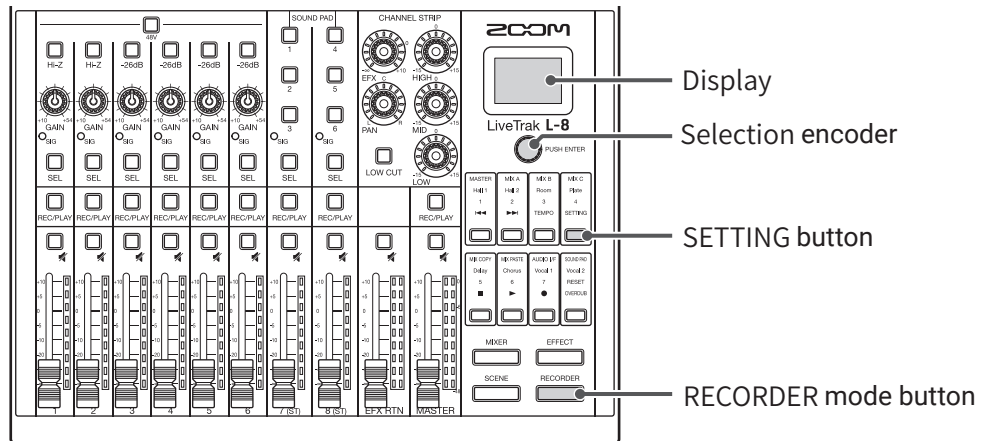

1. Press  so that it lights.  
This opens the RECORDER screen.



---

2. Press  so that it lights.  
This opens the SETTING screen.

---

3. Use  to open REC/PLAY > PLAY MODE.

---

4. Turn  to select the play mode, and press .





Setting	Explanation
OFF	Only the selected project plays back. Playback continues even when the end of a file is reached.
PLAY ONE (single playback)	Only the selected project plays back. Playback stops when the end of a file is reached.
PLAY ALL (all playback)	Every project from the selected one to the last one will be played back.
REPEAT ONE (single repeat playback)	The selected project will be played repeatedly.
REPEAT ALL (all repeat playback)	All projects will be played back repeatedly.

# SD card settings

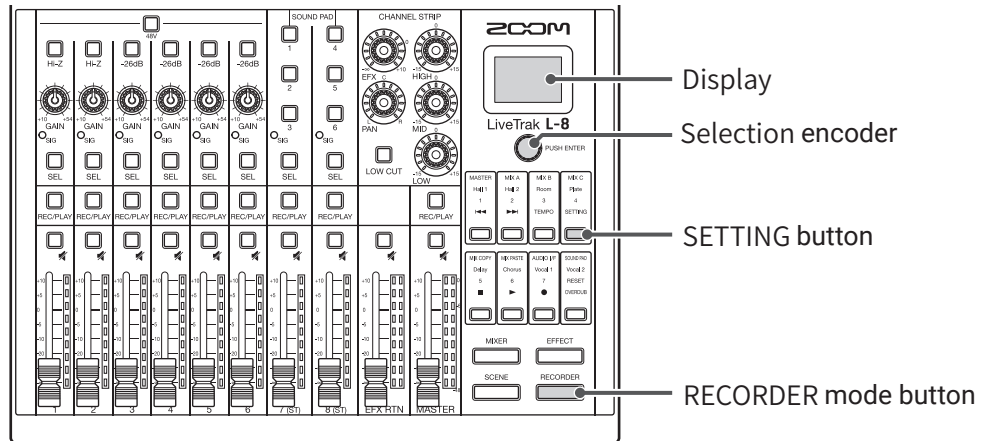
## Checking the open space on SD cards



1. Press  so that it lights.  
This opens the RECORDER screen.
2. Press  so that it lights.  
This opens the SETTING screen.
3. Use  to open **SD CARD** > **REMAIN**.  
This shows the open space on the card.

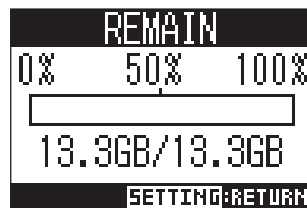



### NOTE

The **L-8** shows less than the actual open space in order to maintain space to prevent SD card writing performance from degrading.

# Formatting SD cards

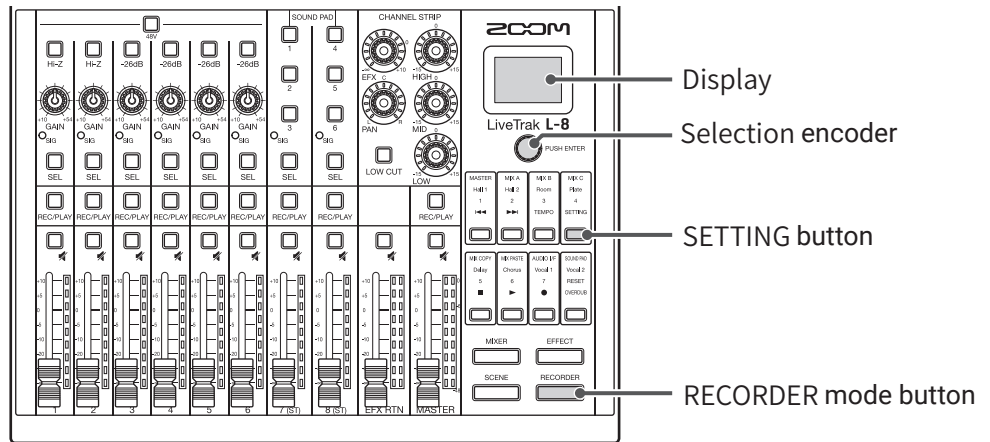
Formatting SD cards for use with the **L-8**.



1. Press  so that it lights.  
This opens the RECORDER screen.



---

2. Press  so that it lights.  
This opens the SETTING screen.

---

3. Use  to open **SD CARD** > **FORMAT**.

---

4. Turn  to select **YES**, and press .

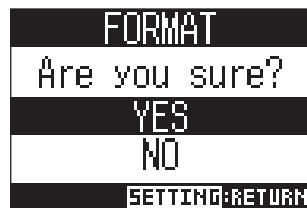

## NOTE



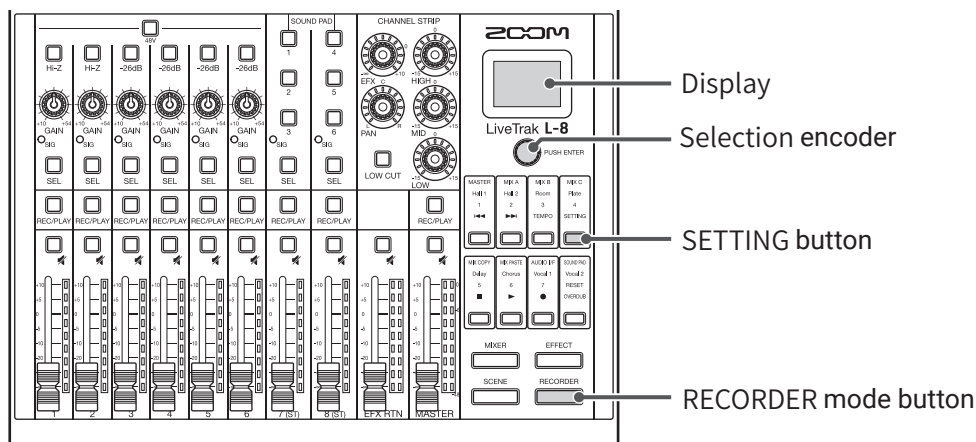

- Before using SD cards that have just been purchased or that have been formatted on a computer, they must be formatted by the **L-8**.
- Be aware that all data previously saved on the SD card will be deleted when it is formatted.
- Format an SD card before recording to it at 96 kHz.

# Testing SD card performance

SD cards can be tested to confirm whether they can be used with the **L-8**.  
A basic test can be done quickly, while a full test examines the entire SD card.



## Conducting a quick test

1. Press  so that it lights.  
This opens the RECORDER screen.
2. Press  so that it lights.  
This opens the SETTING screen.
3. Use  to open **SD CARD** > **CARD TEST**.
4. Turn  to select **QUICK TEST**, and press .



5. Turn  to select **YES**, and press .

The card performance test will start. The test should take about 30 seconds.

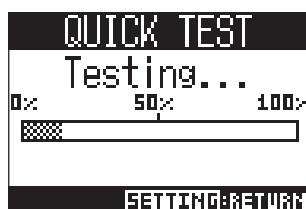

The result of the test will be shown when it completes.

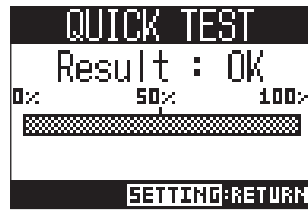



6. Press  anytime to stop the test.

**NOTE**



Even if a performance test result is "OK", there is no guarantee that writing errors will not occur. This information is just to provide guidance.

## Conducting a full test

1. Press  so that it lights.  
This opens the RECORDER screen.

2. Press  so that it lights.  
This opens the SETTING screen.

3. Use  to open **SD CARD** > **CARD TEST**.

4. Turn  to select **FULL TEST**, and press .
- The amount of time required will be shown.



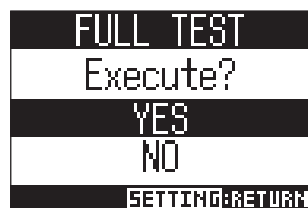

5. Turn  to select **YES**, and press .

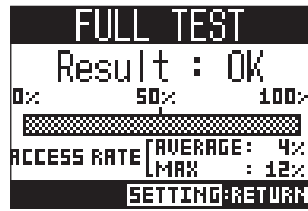

The result of the test will be shown when it completes.

If the access rate MAX reaches 100%, the card will fail (NG).



6. Press  anytime to stop the test.



**NOTE**

Even if a performance test result is "OK", there is no guarantee that writing errors will not occur. This information is just to provide guidance.

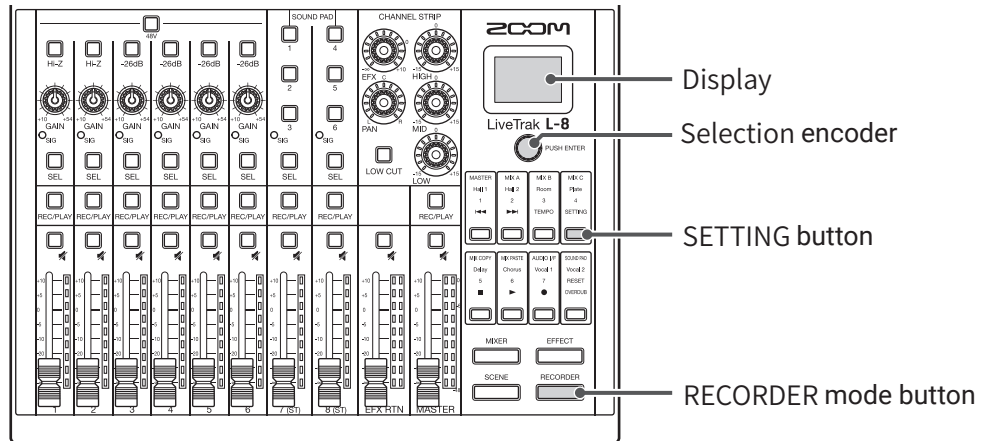

# Making various settings

## Setting the date and time

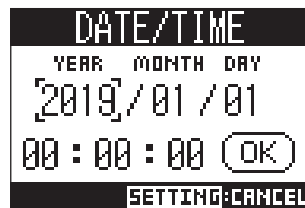

1. Press  so that it lights.  
This opens the RECORDER screen.
2. Press  so that it lights.  
This opens the SETTING screen.
3. Use  to select **SYSTEM > DATE/TIME**.
4. Setting the date and time



- Move cursor/change value: Turn  PUSH ENTER
- Select item/confirm change: Press  PUSH ENTER

5. Turn  PUSH ENTER to select **OK**, and press  PUSH ENTER.

The first time you turn the power on after purchase, you must set the date/time.



# Changing the sampling rate

The file format used when recording to the recorder depends on this setting.

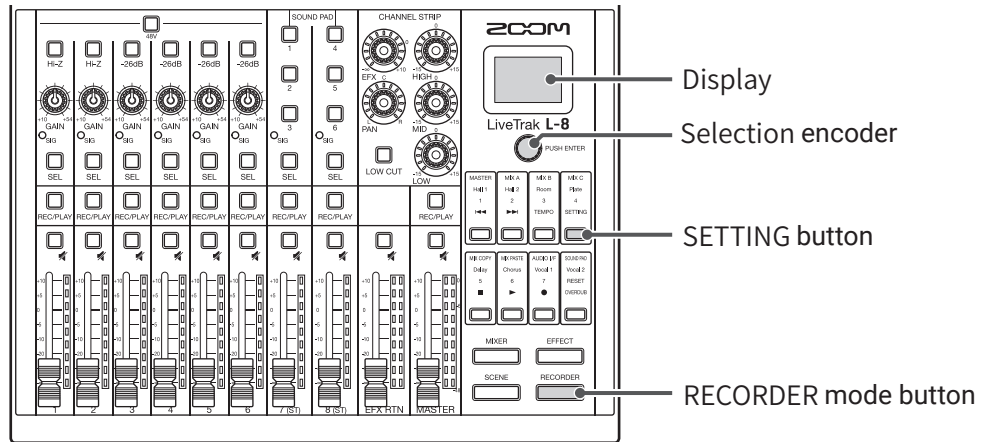

1. Press  so that it lights.  
This opens the RECORDER screen.



---

2. Press  so that it lights.  
This opens the SETTING screen.

---

3. Use  to select **SYSTEM** > **SAMPLE RATE**.

---

4. Turn  to select the sample rate, and press .



## HINT

This can be set to 44.1 kHz, 48 kHz or 96 kHz.

## NOTE

- Format an SD card before recording to it at 96 kHz. Without formatting first, skipping could occur when recording.
- When 96 kHz is selected, some **L-8** functions are limited. The limited functions are as follows.
  - SEND EFX: disabled
  - EQ: disabled
  - OVERDUB: disabled
  - Audio interface: disabled
  - SOUND PAD: disabled
  - MONITOR OUT: output signal same as MASTER only
- If a project is loaded that has a different sampling rate than the **L-8** setting, recording and playback will not be possible.

# Disabling the automatic power saving function

The power will automatically turn off if the **L-8** is unused for 10 hours.

To keep the power on at all times, disable the automatic power saving function.

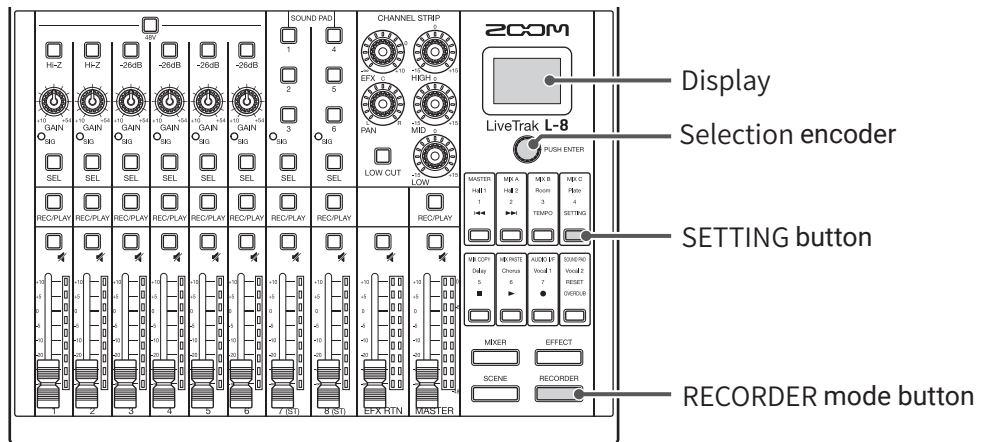

1. Press  so that it lights.  
This opens the RECORDER screen.



---

2. Press  so that it lights.  
This opens the SETTING screen.

---

3. Use  to select **SYSTEM > AUTO POWER OFF**.

---

4. Turn  to select **OFF**, and press .

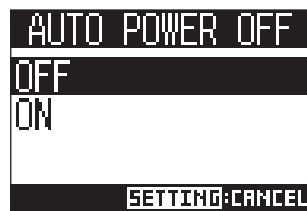



## NOTE

This setting is saved in the **L-8**.

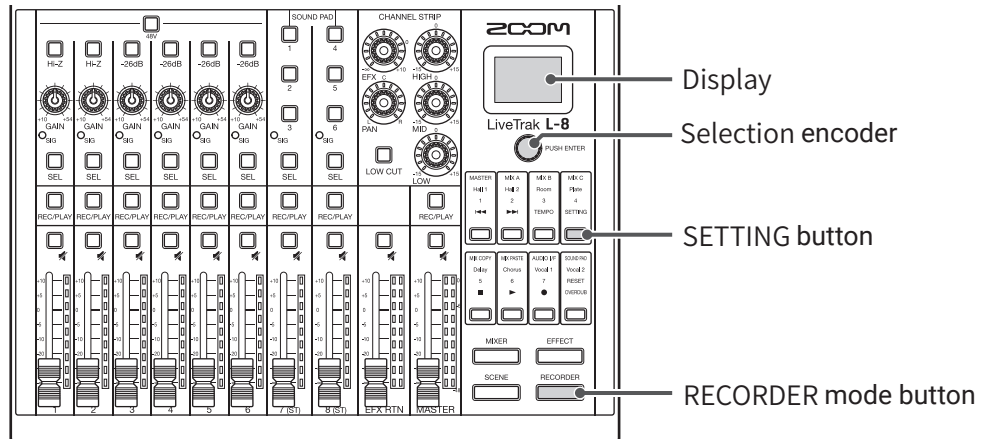

# Adjusting the display contrast



1. Press  so that it lights.  
This opens the RECORDER screen.

2. Press  so that it lights.  
This opens the SETTING screen.

3. Use  to select **SYSTEM > LCD CONTRAST**.

4. Turn  to select the setting value, and press .



## HINT

This can be set from 1 to 10.

# Setting the display backlight

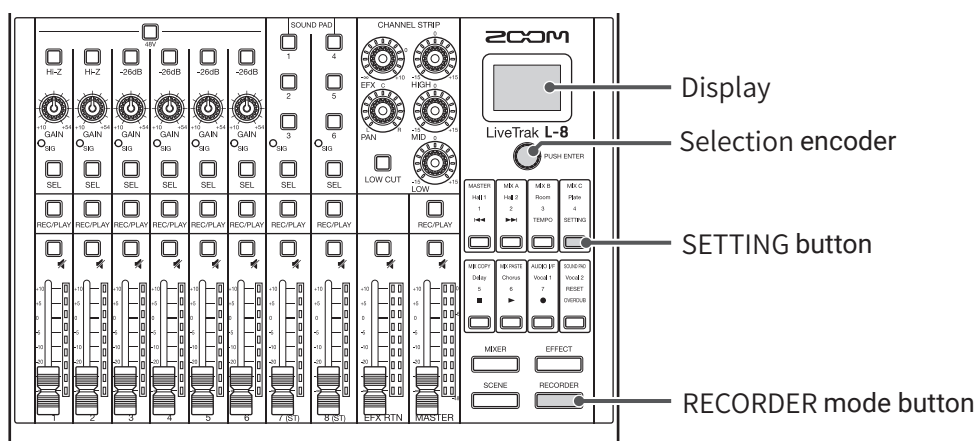

1. Press  so that it lights.  
This opens the RECORDER screen.



---

2. Press  so that it lights.  
This opens the SETTING screen.

---

3. Use  to select **SYSTEM > LCD BACKLIGHT**.

---

4. Turn  to select the setting value, and press .



Setting	Explanation
ON	Backlight always lit
OFF	Backlight always unlit
15sec	Backlight turns off after 15 seconds without operation
30sec	Backlight turns off after 30 seconds without operation

## NOTE

Even when the backlight is off, conducting an operation will cause it to light.

# Setting the type of batteries used

Set the type of battery used correctly so that the amount of remaining battery charge can be shown accurately.

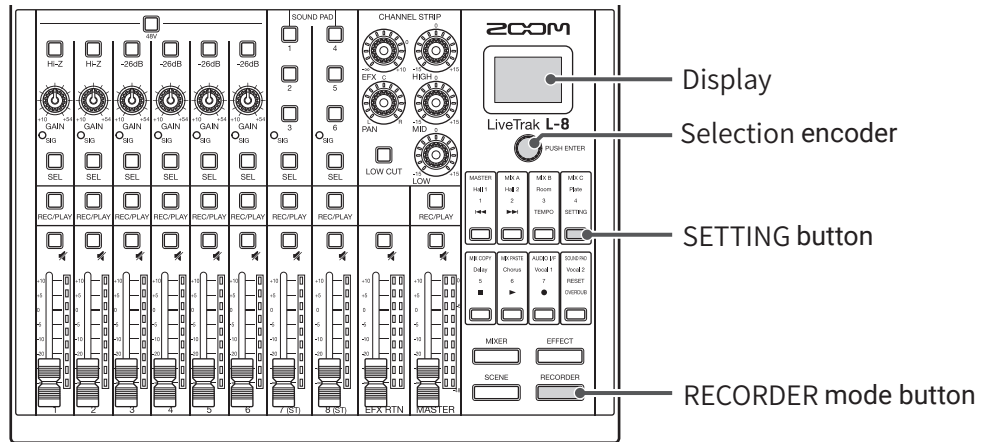

1. Press  so that it lights.  
This opens the RECORDER screen.



---

2. Press  so that it lights.  
This opens the SETTING screen.

---

3. Use  to select **SYSTEM** > **BATTERY**.

---

4. Turn  to select the setting value, and press .



Setting	Explanation
Alkaline	Alkaline batteries
Ni-MH	Nickel-metal hydride batteries
Lithium	Lithium batteries

# Setting the battery saving mode

To prevent battery consumption during operation on batteries, indicator and button illumination can be dimmed after 15 seconds without operation.

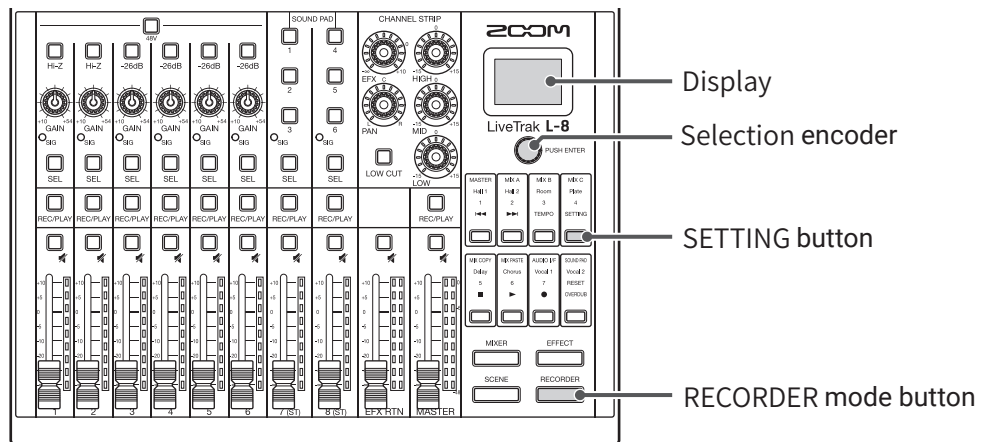

1. Press  so that it lights.  
This opens the RECORDER screen.



---

2. Press  so that it lights.  
This opens the SETTING screen.

---

3. Use  to select **SYSTEM > BATTERY SAVING**.

---

4. Turn  to select the setting value, and press .

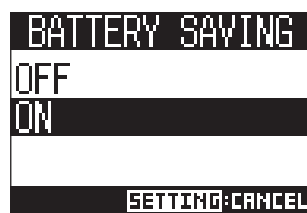

Setting	Explanation
ON	This turns the battery saving mode on.
OFF	This turns the battery saving mode off.

## NOTE





Even when the battery saving mode is on, the following indicators and buttons stay lit.

- SIG indicators
- USB indicators
- LINE input indicators
- Smartphone connection indicator

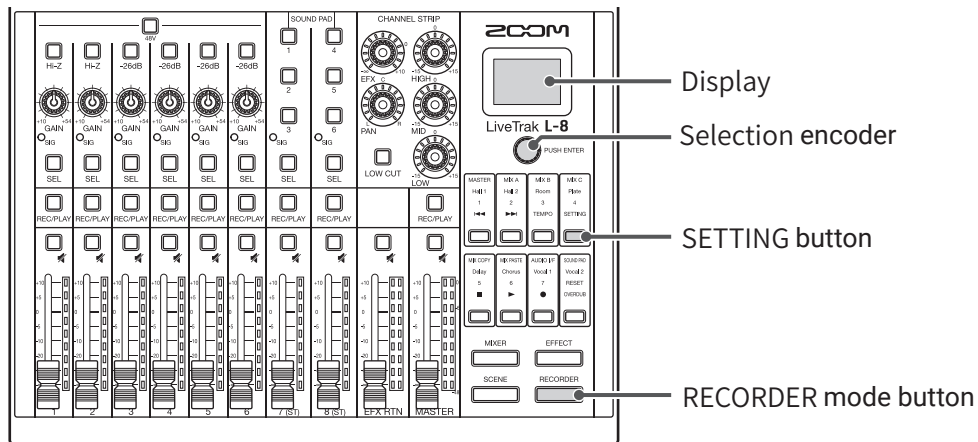
# Restoring settings to factory defaults

The factory default settings can be restored.



1. Press  so that it lights.  
This opens the RECORDER screen.
2. Press  so that it lights.  
This opens the SETTING screen.
3. Use  to select **SYSTEM** > **FACTORY RESET**.
4. Turn  to select **YES**, and press .

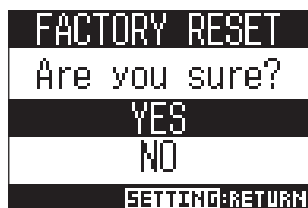



## NOTE

This does not reset mixer settings. ( → [“Resetting mixer settings”](#) on page 35)

# Checking the firmware versions

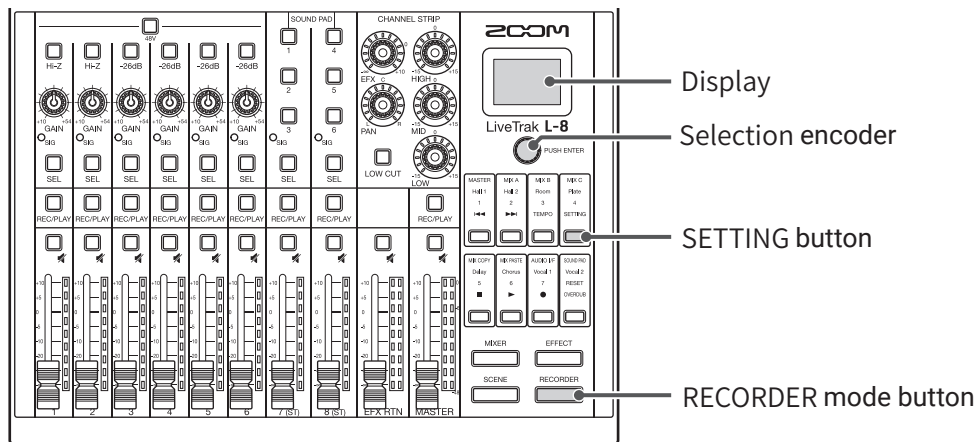
The **L-8** firmware versions can be viewed.



1. Press  so that it lights.  
This opens the RECORDER screen.

2. Press  so that it lights.  
This opens the SETTING screen.

3. Use  to select **SYSTEM > VERSION**.  
This shows the firmware versions.





# Updating the firmware

The **L-8** firmware can be updated to the latest versions.

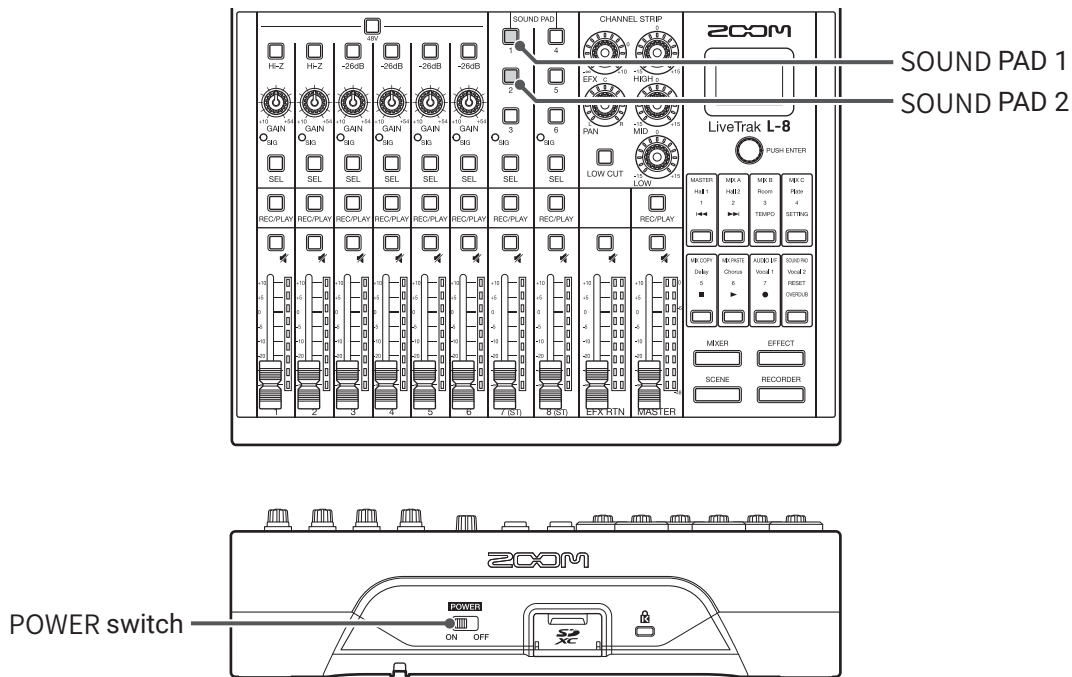



1. Copy the firmware update file to the root directory on an SD card.

## NOTE

Files for the latest firmware updates can be downloaded from the ZOOM website ([zoomcorp.com](http://zoomcorp.com)).

2. Insert the SD card into the **L-8**.

3. While pressing  (SOUND PAD), set  to ON.

## NOTE

Firmware updates are not possible when operating on battery power.

4. Press  (SOUND PAD).

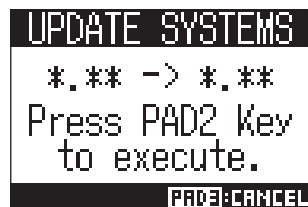

## NOTE

During the firmware update, do not turn the power off or remove the SD card. Doing so could cause the **L-8** to become unstartable.

5. After the firmware update completes, turn the  off.



**NOTE**

In the unlikely event that a firmware update should fail while in progress, conduct the procedures from the beginning to update the firmware again.





# Troubleshooting

---

## General



### There is no sound or output is very quiet

---

- Check the speaker connections and volume settings on the speakers.
- Check instrument and mic connections.
- When using a condenser mic, turn  on.
- Confirm that  is lit green.
- Confirm that  is unlit.
- Raise all the channel faders and the master fader, and confirm that the level meters are lit.
- Confirm that the MASTER  is unlit or lit red.

### Recorded audio is too loud, too quiet or silent

---

- Adjust input gains and confirm that  is lit green.
- When using a condenser mic, turn  on.
- When recording to an SD card, confirm that  is lit red.

### Recording is not possible

---

- When recording to an SD card, confirm that  is lit red.
- Confirm that the SD card has open space.
- When recording to an SD card, confirm that the project is not protected (to prevent overwriting).

### “Write Error” appears and recording is not possible/ stopping recording takes too much time

---

- SD cards can become worn out. Speed can decrease after repeated writing and erasing.
- Formatting the card with the **L-8** might improve this. ( → [“Formatting SD cards” on page 92](#) )
- If formatting an SD card does not improve this, we recommend replacing the card. Please check the list of cards that have been confirmed to work on the ZOOM website.

#### NOTE

This list is provided as a guideline to help find suitable cards. It is not a guarantee of specific SD card recording performance for SDHC/SDXC cards that have been confirmed to work.

## Playback sound cannot be heard or is quiet

---

- When playing data from an SD card, confirm that  is lit green.
- Raise the faders on the playback channels, and confirm that the level meters are lit.

## The sounds of devices connected to input jacks are distorted

---

- Confirm that  $\bigcirc_{\text{SIG}}$  are not lighting red. If one is lighting, lower its input gain.  can also be turned on.
- Confirm that level meters are not lighting to their highest levels. If a level meter is lighting to its highest level, lower its fader.

## A send effect is not working

---

- Confirm that the EFX RTN  is unlit.
- Raise the EFX RTN fader, and confirm that the EFX RTN level meters are lit.
- Check the send amounts of channels that are to have effects used on them.

## There is no sound or output is very quiet from MONITOR OUT A–C

---

- Confirm the mixes of each output.
- Confirm that the output volume of each output is raised (MONITOR OUT A–C knobs).
- Check the MONITOR OUT A–C switch settings.

## Audio files cannot be assigned to SOUND PAD buttons or tracks

---

- Check the format of the audio file to be assigned. ( → [“Assigning audio files to SOUND PAD buttons” on page 53](#), → [“Assigning audio files to tracks” on page 74](#))
- If the audio file is stored on an SD card, store it outside the PROJECT folder.

## EQ, built-in effect or audio interface functions cannot be used

---

- Confirm that the sampling rate is set to 44.1 kHz or 48 kHz.

## SOUND PAD functions cannot be used



---

- Confirm that INPUT SEL is set to SOUND PAD.
- Confirm that the level meters for channels 7 and 8 are lit.
- Confirm that files are assigned.
- Confirm that the sampling rate is set to 44.1 kHz or 48 kHz.

## Audio interface

### Cannot select or use the L-8

---

- Confirm that the **L-8** is connected to the computer correctly.
- Press  >  to open the AUDIO I/F screen, and confirm that the connected device type is correct.
- Quit all the software that is using the **L-8**, and turn the **L-8** off and on again.
- Reinstall the driver.
- Connect the **L-8** directly to a USB port on the computer. Do not connect it through a USB hub.



### Sound skips during playback or recording

---

- If the audio buffer size of the software being used can be adjusted, increase the buffer size.
- Connect the **L-8** directly to a USB port on the computer. Do not connect it through a USB hub.
- Turn the automatic sleep function and other computer power saving settings off.

### Cannot play or record

---



- Confirm that the **L-8** is connected to the computer correctly.
- Confirm that the Sound setting of the computer being used is set to "ZOOM L-8".
- Confirm that **L-8** is set for input and output in the software that you are using.
- Confirm that  and  as well as the level meters are lit.
- Quit all the software that is using the **L-8**, and disconnect and reconnect the USB cable connected to the **L-8**.

# Specifications

<b>Number of input and output channels</b>	<b>Inputs</b>	MIC/LINE	6
		LINE	2
	<b>Output</b>	MASTER OUT	1
		MASTER OUT (PHONES)	1
MONITOR OUT (PHONES)		3	
<b>Inputs</b>	<b>MIC/LINE</b>	Type	XLR/TRS combo jacks (XLR: 2 HOT, TRS: TIP HOT)
		Input gain	+10 – +54 dB/–3 – +41 dB (when Hi-Z ON)
		Input impedance	XLR: 3 kΩ TRS: 3 kΩ/1 MΩ (when Hi-Z ON)
		Maximum input level	–2 dBu when –26dB switch OFF (at 0 dBFS) +24 dBu when –26dB switch ON (at 0 dBFS)
		Phantom power	+48 V
	<b>LINE</b>	Type	TS phone jack
		Input impedance	10 kΩ
		Maximum input level	+3 dBu
	<b>Smartphone connection jack</b>	Type	TRRS mini jack (4-contact/TIP: L, RING 1: R, RING 2: GND, SLEEVE: MIC)
		Input impedance	10 kΩ
		Maximum input level	+3 dBu
	<b>Output</b>	<b>MASTER OUT</b>	Type
Maximum output level			+14.5 dBu
Output impedance			100 Ω
<b>MASTER OUT (PHONES)</b>		Type	Standard stereo phone jack
		Maximum output level	10 mW + 10 mW (60Ω load)
		Output impedance	10 Ω
<b>MONITOR OUT (PHONES)</b>		Type	Standard stereo phone jack
		Maximum output level	10 mW + 10 mW (60Ω load)
		Output impedance	10 Ω
<b>Buses</b>	MASTER	1	
	MONITOR	3	
	SEND EFX	1	
<b>Channel strip</b>	LOW CUT	75 Hz, 12 dB/OCT	
	EQ	HIGH: 10 kHz, ±15 dB, shelving MID: 2.5 kHz, ±15 dB, peaking LOW: 100 Hz, ±15 dB, shelving	
<b>Level meter</b>		9 segments	
<b>Send effects</b>		8 types	
<b>Recorder</b>	Maximum simultaneous recording tracks	12 at 44.1/48/96 kHz	
	Maximum simultaneous playback tracks	10	
	Recording format	WAV 44.1/48/96 kHz, 16/24-bit, mono/stereo	
	Recording media	4GB–32GB SDHC-compliant cards (Class 10 or higher) 64GB–512GB SDXC-compliant cards (Class 10 or higher)	
<b>Audio interface</b>	44.1/48 kHz	Recording: 12 channels      Playback: 4 channels	
	Bit depth	24-bit	
	Interface	USB 2.0	
<b>Card reader</b>	Class	Mass storage      USB 2.0 High Speed	
<b>Sampling frequency</b>		44.1/48/96 kHz	
<b>Frequency response</b>		20 Hz – 20 kHz: –1 dB at 44.1 kHz 20 Hz – 40 kHz: –3 dB at 96 kHz (when GAIN at 3 o'clock)	
<b>Equivalent input noise</b>		–121 dBu or less (IHF-A) at +54dB/150Ω input	
<b>Display</b>		LCD with backlight (96×64 resolution)	
<b>Power</b>		4 AA batteries (alkaline, lithium, or rechargeable NiMH) AC adapter (ZOOM AD-17): DC 5V/1A Supports USB bus power	
<b>Estimated continuous recording time using batteries</b>		Recording 44.1kHz/16-bit/4ch audio to SD card (when 48V is OFF, LCD BACKLIGHT is 15sec, BATTERY SAVING is ON and headphone impedance is 62Ω): Alkaline batteries: about 1.5 hours NiMH batteries (1900 mAh): about 3 hours Lithium batteries: about 5 hours • The above values are approximate. • Continuous battery operation times were determined using in-house testing methods. They will vary greatly according to use conditions.	
<b>Power consumption</b>		5 W	
<b>External dimensions</b>		268 mm (W) × 282 mm (D) × 74 mm (H)	
<b>Weight (main unit only)</b>		1.56 kg	

# Send effect specifications

No.	Type	Explanation	Parameter 1	Parameter 2	Tempo sync
1	Hall 1	Hall reverb with a bright tone	TONE	DECAY	
2	Hall 2	Hall reverb with a long time for early reflections	TONE	DECAY	
3	Room	Dense room reverb	TONE	DECAY	
4	Plate	Plate reverb simulation	TONE	DECAY	
5	Delay	Digital delay with a clear tone	TIME	FEEDBACK	●
6	Chorus	Stereo chorus with a clear wide quality	TONE	RATE	
7	Vocal 1	Effect that combines delay suitable for ballads with plate reverb	TIME	DECAY	
8	Vocal 2	Effect suitable for rock that combines delay with room reverb	TIME	DECAY	

Note: The delay effect can be synchronized to the project tempo. To synchronize them, press  > , and set the tempo. Quarter notes will be synchronized to the tempo.

# Mixer block diagram

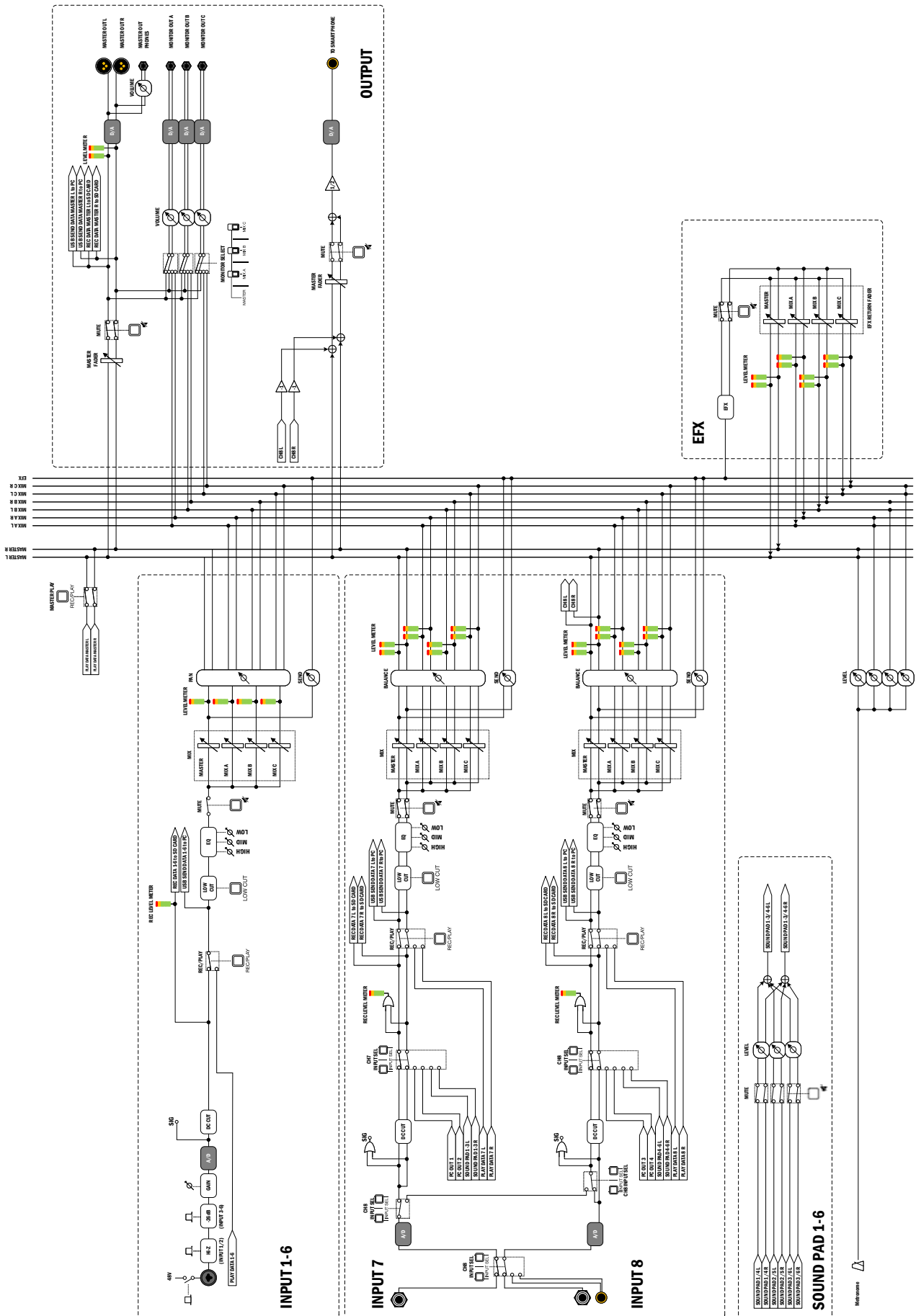





4-4-3 Kanda-surugadai, Chiyoda-ku, Tokyo 101-0062 Japan  
[zoomcorp.com](http://zoomcorp.com)