



Messaging Software

User Manual

FOR

PC & REMOTE OPERATIONS

(REV. 2.0)

Note: Jan 29, 2007

This manual is applied to the model of
M500N-7 series

Note: Specifications are subject to change
without notice

Contents

1: General information	3
1.1: Using a remote control to operate your sign	3
1.2: Using a computer to operate your sign	3
1.3: Attaching your sign to a surface	3
2: Basic sign operation	4
2.1: Turning a sign on and off	4
2.2: System requirement	4
2.3: Software operation	4
2.4: Remote control operation	6
3: Beginning messaging	8
3.1: Example 1- A simple message in seven easy steps	8
3.2: Example 2- Insert text, time, date, symbol, graphic, character and carton	8
3.2.1: Software operation	8
3.2.2: Remote control operation	9
3.3: Example 3- Create / Delete messages into different file names	11
3.3.1: Software operation	11
3.3.2: Remote control operation	12
3.4: Example 4- Adjustment of methods, fonts or colors	12
3.4.1: Software operation	12
3.4.2: Remote control operation	13
3.5: Example 5- Insert beep, speed or pause	13
3.5.1: Software operation	13
3.5.2: Remote control operation	13
4: Advanced messaging	14
4.1: Example 6- Setting time or date	14
4.1.1: Software operation	14
4.1.2: Remote control operation	14
4.2: Example 7- Programming filename messages in sequence	15
4.2.1: Software operation	15
4.2.2: Remote control operation	16
4.3: Example 8- Creating your own custom graphics & logo	16
4.3.1: Software operation	16
4.3.2: Remote control operation	18
4.4: Example 9- Displaying your own custom graphics & logo	20
4.4.1: Software operation	20
4.4.2: Remote control operation	20
5: Other timer options	21
5.1.1: Software operation	21
5.1.2: Remote control operation	22
Appendix A: Additional programming tips	23
Appendix B: Listing of color	25
Appendix C: Listing of international characters	25
Appendix D: Listing of symbol characters	26
Appendix E: Change password	26
Troubleshooting	27

1: General Information

You can operate the sign in two ways:

- ⌘ By using a hand-held remote control
- ⌘ By using personal computer

1.1: Using a remote control to operate your sign

A remote control is a hand-held keyboard used to operate the sign. This manual shows you how to program messages on your sign using a remote control.

1.2: Using a computer to operate your sign

To do this, you'll need special connectors and computer software as following shown:

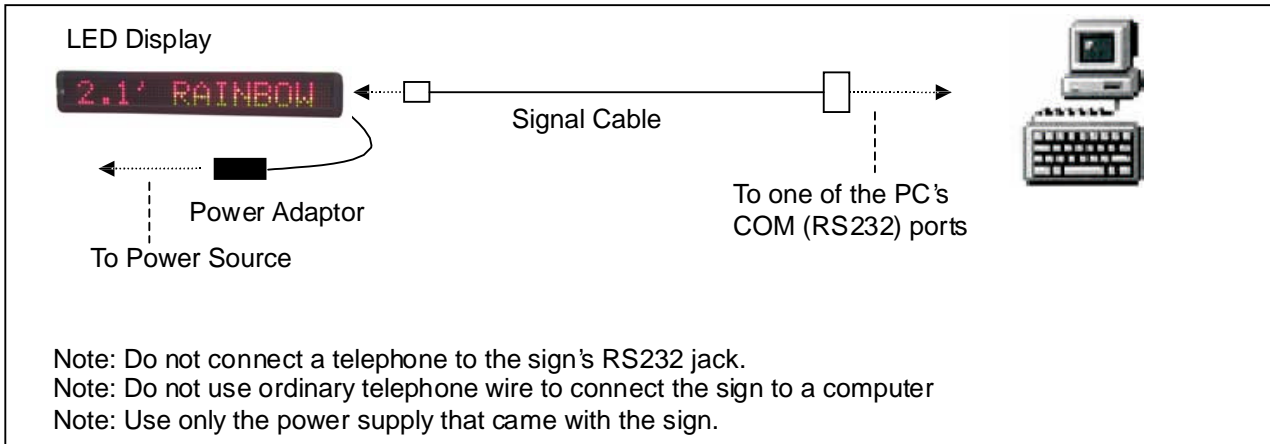

1.3: Attaching your sign to a surface

Your sign can be mounted to a wall.

Note: This sign is intended for indoor use only.

Note:

- ⌘ Do not mount or attach the power supply to anything.
- ⌘ Do not let the power supply hang loose.
- ⌘ Place the power supply on a flat surface where no chemicals or liquid, such as water, will contact it.
- ⌘ Plug the power supply into an easily accessible electrical outlet

Wall mount

1. Attach the mounting brackets to the wall or surface.
2. Attach the sign to mounting brackets using hardware as shown below.
3. Plug the power cord into the sign and into an outlet.

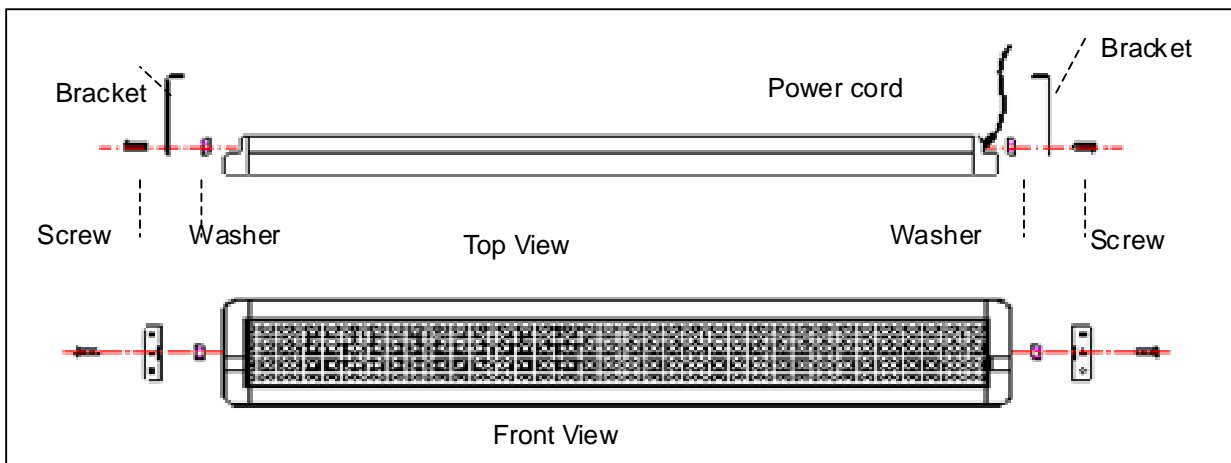

2: Basic Sign Operation

2.1: Turning a sign on and off

When you plug in the sign's power supply, the sign starts up automatically. On the other hands, in order to turn the sign off, you can unplug the power supply or use the remote control.

2.2: System requirement

The computer must be Pentium 200 or above, 32M memories, 2M or above display memory, 100M empty hard disk. The computer must be installed window 95 or above version. The display mode is designed for 800x600, 16-bit or 24-bit colors.

2.3: Software operation

Messaging Software allows you to send messages to your sign using a computer. Please follow the steps to activate your software:

- Turn on your computer and start Windows 98/2000/XP.
- Insert the software CD disk into CD-ROM, or you can copy the software into your PC for the easy operation.
- Double click the  icon to activate the programming software, this is what should appear on your computer screen:

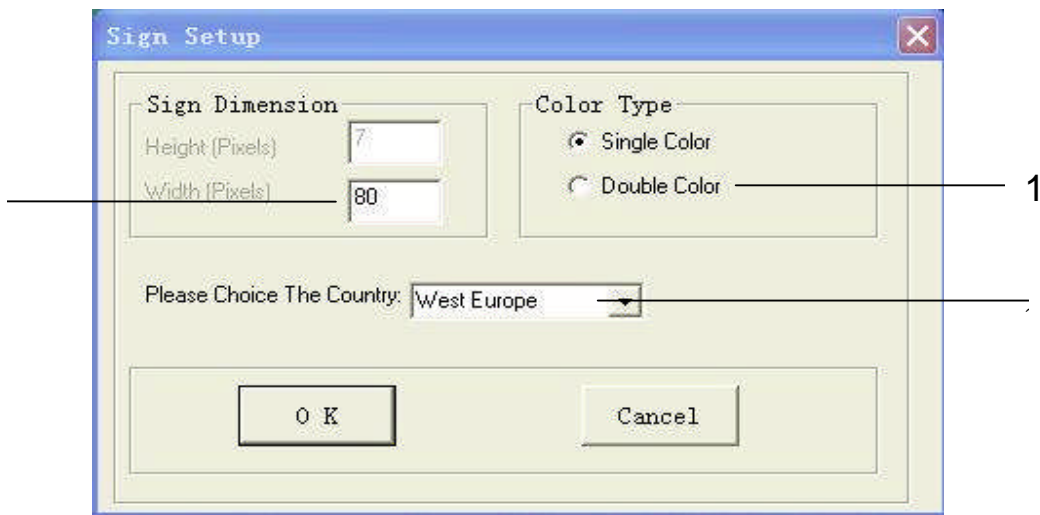

Letter	Name	Description
1	Color	If your sign is tricolor (Red, Green & Amber), please select Double Color . Otherwise, please select single color.
2	Text Size /pixel	The length of message sign, unit in pixel. The default setting is 80
3	Country option	For new countries, select following choice for the operations

- Click **OK** to enter into the main screen as follows;

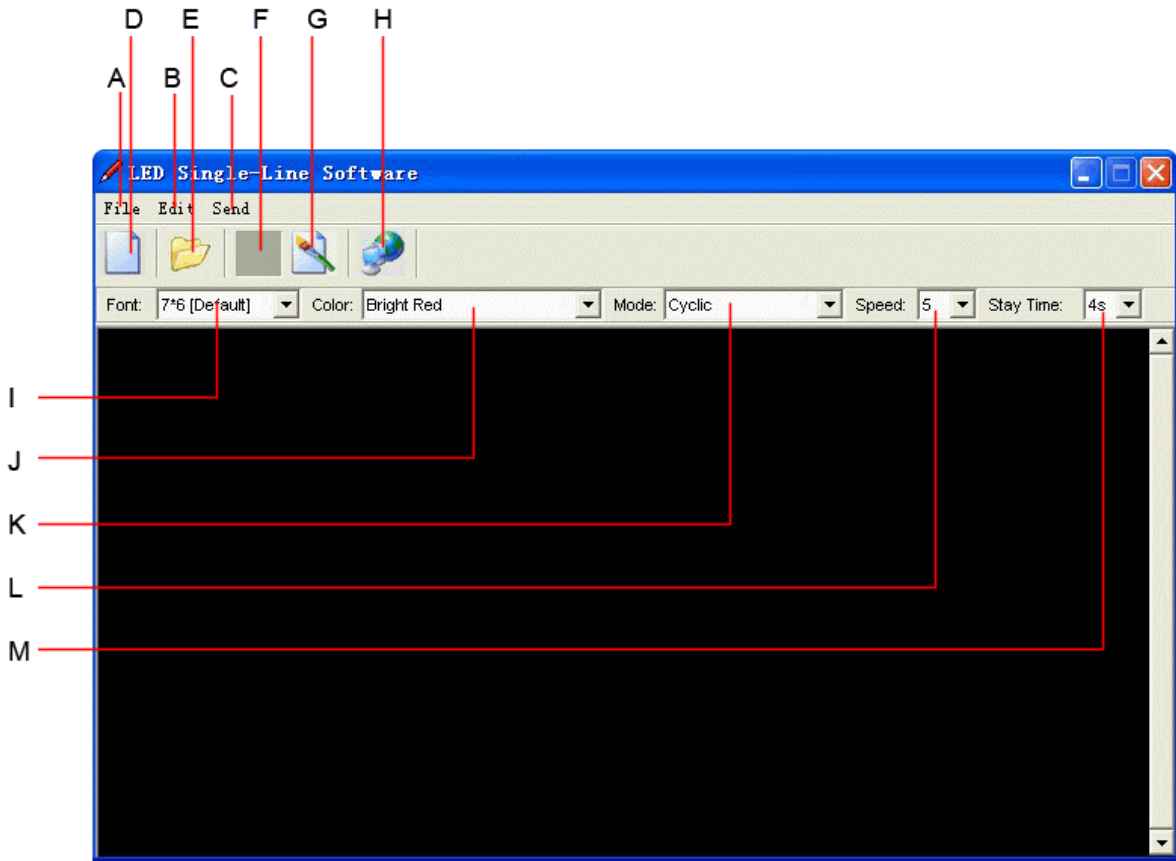

Overview of screen layout

Letter	Name	Sub-menu	Description
A	File	Clear	Clear all the contents in text edit area
		Open...	Open the old files (*.sdv)
		Save	Save the file of the current text edit area for later using
		Save as...	Save the file of the current text edit area as a new file
		Exit	Exit the messaging software
B	Moving Sign	Send	- Send Edit Area's Content: Update the sign with the new messages in the text edit area - Send Disk File...: Update the sign with stored *.sdv file
		Execution lattice	Create custom 7x80 (height x width) pixels graphics Note: up to 8 custom graphics can be created by users
		Special function	Allow you to schedule, to on/off, to alarm, to adjust time of your sign automatically
		Moving Sign option	Models' selection
		Test	Send a testing signal to the sign
C	Send		Update the sign with the new messages in the text edit area
D	New		Clear all the contents in the text edit area
E	Open		Open an old file (*.sdv)
F	Save		Save the file of the current text edit area (*.sdv) for later using
G	Graphic edit		Create custom 7x80 (height x width) pixels graphics Note: up to 8 custom graphics can be created
H	Font		7 different kind of fonts
I	Color		16 different kind of color combinations
J	Text edit area		Type messages here

2.4: Remote control operation

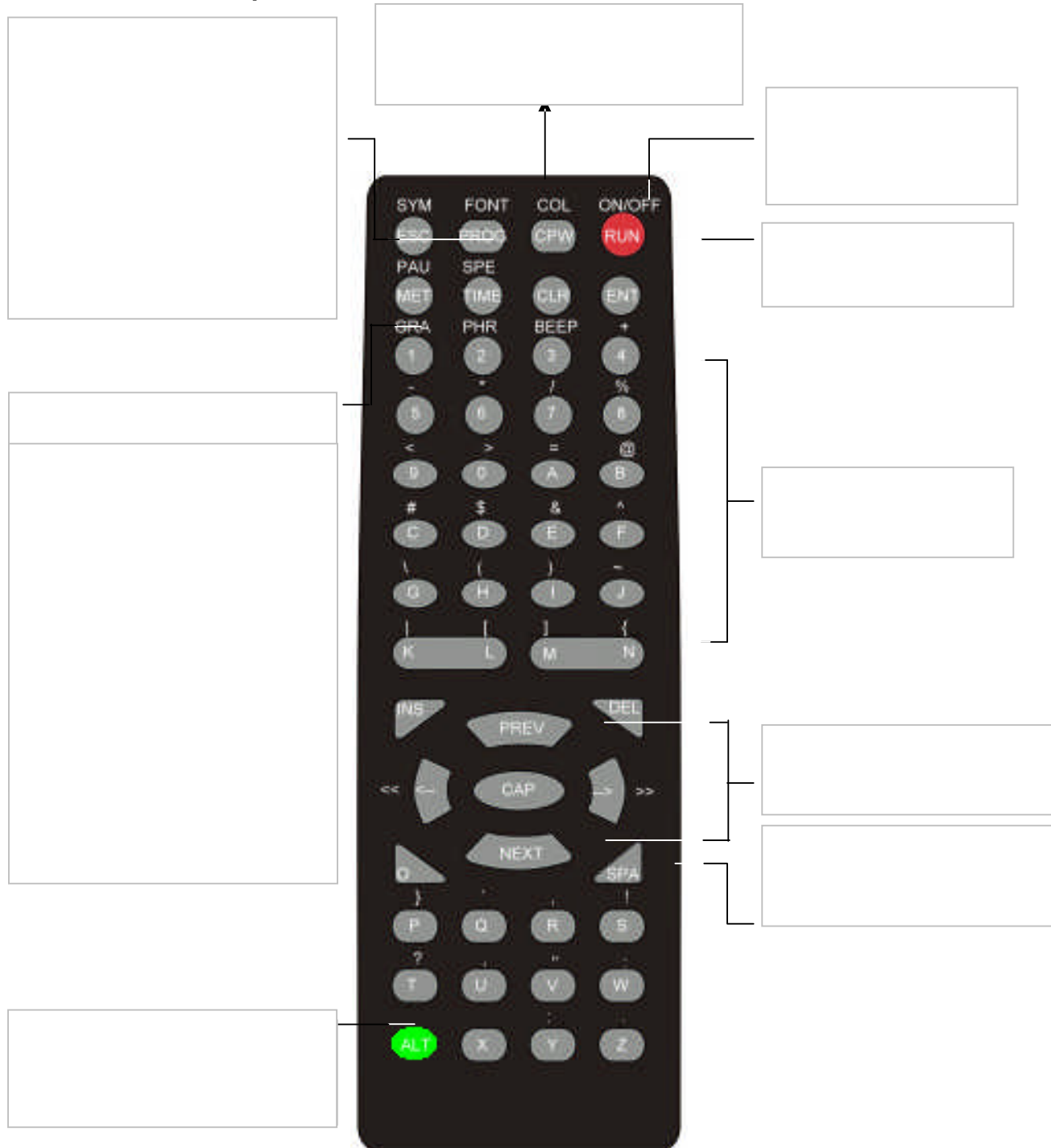

Item	Key	Description
1	ON/OFF	Power On / Off. If there is no file in 01 to 99 , it will run file 00 .If there is file in 01 to 99 , it will display the last saved file.
2	PROG	Enter the Edit Program Mode. Select 01 to 99 to enter message.
3	CPW	Use for edit or reset password
		Use PREV and NEXT to select (a) to (d)(a) UNUSE PASS Turn off password security.(b) USE PASS Turn on password security(c) RES PASS Reset to factory default password " 000 ".(d) CHANGE PASS Change to new password (see
4	MET	To select the display modes, totally up to 24 different modes. Note: Press PREV and NEXT to select (1) to (24) methods. See Appendix A.

5	PREV	Select option backward.
6	NEXT	Select option forward.
7	CAP	Toggle between Capital letter and lower case character.
8	TIME	To select time option. See Appendix B.
9	SPE	Select the display speed of the message. (Use PREV and NEXT to select different speeds.)
10	FONT	Select the font size of the display message. (Use PREV and NEXT to select different font sizes.)
11	COL	Select the color of the display message. (Use PREV and NEXT to select different colors of the display message.)
12	SYM	Select 30 built-in symbols. (Use PREV and NEXT to select different symbols.)
13	CLR	Erase option.
14	GRA	Select graphic option. (Use PREV and NEXT to select the following options:)
		(a) GET GRAPH Place the graphic in the message. Use PREV and NEXT to select GRAPH A to GRAPH P .
		(b) MAKE GRAPH Create new graphics in location NUMBER A to NUMBER H
		(c) EDIT GRAPH Edit GRAPH A to GRAPH P and store in one of the location of NUMBER A to NUMBER H .
15	<=	Moving the message and command to the right.
16	>=	Moving the message and command to the left.
17	ALT	<p>Note:</p> <p>IF YOU WANT TO DELETE MESSAGE OR COMMAND IN THE EDIT PROGRAM MODE.PLEASE USE ABOVE KEYS TO MOVE THAT MESSAGE OR COMMAND TO THE LEFT-MOST POSITION AND PRESS DEL.</p> <p>IF YOU WANT TO INSERT MESSAGE OR COMMAND IN THE EDIT PROGRAM MODE.PLEASE USE ABOVE KEYS TO MOVE THAT MESSAGE OR COMMAND TO THE LEFT-MOST POSITION AND (1)PRESS INS TO INSERT.(2)TYPE IN YOUR MESSAGE OR PRESS COMMAND KEY,IT WILL INSERT AUTOMATICALLY.(3)PRESS INS AGAIN TO OVERWRITE.</p>
18	PAU	Generate a pause within the programmed message. (Use PREV and NEXT to select PAUSE 1 to PAUSE 8)
19	PHR	Select a programmed animation in the message. (Use PREV and NEXT to select ANIM 1 to ANIM 8)
20	BEEP	Select beep sound in the message. (Use PREV and NEXT to select BEEP 1 to BEEP 3)
21	ENT	Accept the selected option.
22	ESC	Return to the upper manual in the edit program mode.
23	INS	Refer to 15 and 16
24	DEL	Refer to 15 and 16
25	SPA	Insert space in message.
26	RUN	(1) In edit program mode, press RUN to save and run the current message. (2) In display mode, press RUN and enter 01 to 99 to select other messages for display.

27	S	Programming a sequence file. Please refer to Section 3.5: Programming a sequence file.									
28	<table border="1"> <tr> <td>F</td> <td>G</td> <td>H</td> </tr> <tr> <td>J</td> <td>K</td> <td>L</td> </tr> <tr> <td>N</td> <td>O</td> <td>P</td> </tr> </table>	F	G	H	J	K	L	N	O	P	Cursor direction pointer . K toggles cursor on /off Note: The direction pointer only works in graphic edit mode
F	G	H									
J	K	L									
N	O	P									

3: Beginning Messaging

3.1: Example 1- A simple message in seven easy steps

The sign can store up to 100 messages in numbered data files. These files are numbered from **00** to **99**. File **00** is a default message and for read only.

A Simple Programming Example –

Note:

Underline denotes words or numbers to type, xxxx denotes key names. To correct a mistake, Press the DEL key to remove it.

User can toggle the capital letter and small letter by pressing the key CAP, and use the ALT key to display symbol on keypad. Default Password: "000"

Step	Keys to press	Explanation	Display
1.	PRO	Begin the edit program mode	PASSWORD:***
2.	0 0 0	Default Password "000"	PASSWORD:***
3.	ENT	Enter into editing mode	OPEN: ??
4.	01 ENT	The first two digit file number (01-99) are allowed for naming message files [CYCLIC] is the default method of display code which means to cycle through at random	[CYCLIC]
5.	WELCOME VISITORS	Type the text you wish to display in you message 	WELCOME VISITORS
6.	RU	End the edit program mode	SAVE? (Y/N)
7.	Y	Save the message as data file number 01	Message begins to be displayed

3.2: Example 2- Insert text, time, date, symbol, graphic, character or carton

3.2.1: Software operation

(2) Click it to send the messages into the FILE01 (default) of your sign.

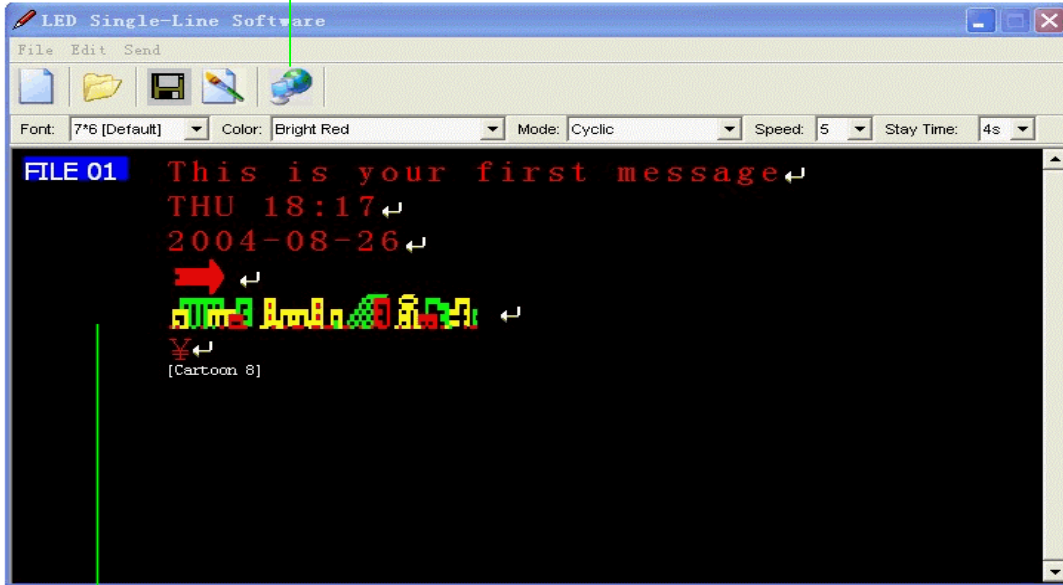

(1) Insert text by typing and Right click the mouse to add time, date, symbol, graphic, character and carton respectively.

Note: The default front and color are **7X 6** and **Bright Red**, respectively.

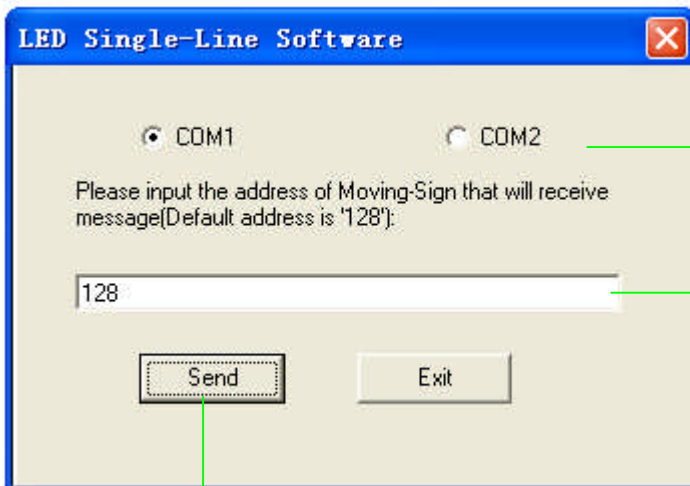

(3) Select a suitable COM port, i.e. COM1 or COM2

(4) Input the value (default = 128)

(5) Click **OK** to start the transmission. The sign will display the new message

Note: The display mode is **Cyclic** in the example

Note: If the display message is longer than one page of LED screen whatever the display method used, the display method will be **[OPEN←]**

3.2.2: Remote Control Operation

Step	Keys to press	Explanation	Display
1	PROG	Begin the edit program mode	PASSWORD:***
2	000	Default Password "000"	PASSWORD:***
3	ENT	Enter into editing mode	OPEN:??
4	01 ENT	The first two digit file number (01-99) are allowed for naming message files [CYCLIC] Is the default method of display code which means to cycle through at random	[CYCLIC]
5	CPW ENT	To disable password function **Note: Suppose the password function was disabled in the rest of this manual.	[UNUSE PASS]
6	This is your first message	Type the text you wish to display in your message	This is your first message
7	Time	Enter into time function mode	SET TIME
8	PREV PREV PREV PREV ENT	Insert time to display your message	ADD TIME
9	Time	Enter into time function mode	SET TIME
10	PREV PREV PREV ENT	Insert date to display your message	ADD DATE
11	SYM	Enter into symbol mode	[-><-]
12	PREV or NEXT ENT	Specified graphic function mode	[→]
13	GRA	Enter into graphic function mode	GET GRAPH
14	PREV or NEXT ENT	Specified graphic is selected	[GRAPH A]
15	\$	Enter into character function mode	[\$]
16	PREV or NEXT ENT	Specified character is selected	[¥]
17	PHR	Enter into cartoon function mode	[ANIM 1]
18	PREV or NEXT ENT	Specified cartoon is selected	[ANIM 8]
19	RUN	End the edit program mode	SAVE? (Y/N)
20	Y	Save the message as data file number 01	Message begins to be displayed

Here are some important things that you learned from this first example:

- * An audible beep is heard when the unit accepts programming input from the remote. This can assure you that the signal from remote has been received and understood.
- * The default color for messages is Bright Red and the default font size is 7*6.
- * You have the option to save your message at the end of your programming.

- * The sign always begins with the default method of display as **[CYCLIC]**, which stands for cycle through all color and method possibilities at random. – Page10–
- * In order to use international characters in your messages, you should first key in the corresponding equivalent English character and then use the **NEXT** and **PREV** buttons to scroll through the international characters, i.e.(Key in "\$"and press the **NEXT** button you will see the "¢"character appears). For the international characters which do not have corresponding English character, please key in a SPACE and then use the **NEXT** and **PREV** buttons to scroll through the list of available characters. See Appendix D for the more information.

3.3: Example 3- Create / Delete messages into different file names

You can create / delete messages into different FILE No. by using keyboard or hand-held remote control.

3.3.1: Software operation

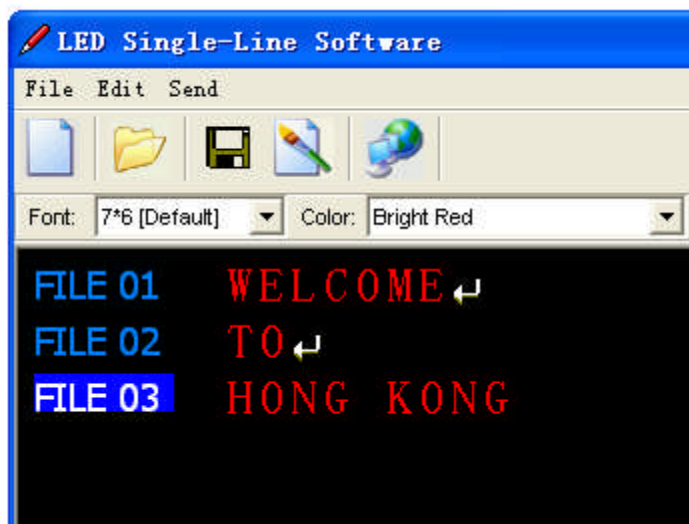

- * To create different file names such as FILE 02, FILE 03 and so on , you can press **CTRL** + **ENTER** key. *Note: totally, users can create files from 01 to 99.
- * If you make mistakes while typing, you can correct them by pressing **DEL** key until you have removed the mistake(s) and re-entered in the message properly.

3.3.2: Remote Control Operation

To create and edit message used by remote control, you should follow the below steps. If there is a previously stored message under that file number, the display will show **[OLDFIL]** **[CYCLIC]**, or may not be **[CYCLIC]** depending on actual content.

Step	Keys to press	Explanation	Display
1.	PROG	Begin the edit program mode	OPEN??
2.	01 ENT	This is the file number for the previously stored message file.	OLDFIL [CYCLIC]
You then can edit or create new message.....			
3.	RUN	End the edit program mode	SAVE? (Y/N)
4.	Y	There is a need to re-save the data file	Message begins to be displayed

In some circumstance, user may like to erase some of the message; the sign has such an option for user to do so. After enter the Edit Mode, user can press the key **CLR** and cycling through the difference functions by pressing the **PREV** or **NEXT** key.

Listed below is the Erase functions and their usages:

- DEL ALL Clear all message files
- DEL FILE ?? Delete the specified file
- DEL MSG Delete the message of the current opening file
- DEL ON/OFF Disable the Auto Turn on /Turn off timer function
- DEL ALARM Disable the alarm function

3.4: Example 4- Adjustment of methods, fonts and colors

Method: Type of moving options which are displayed on a sign, see Appendix A.

Fonts: Style of fonts which are displayed on a sign, see Appendix A too.

Colors: Your sign can display up to 16 different colors, e.g: Red, Green, Yellow, etc. – plus 8

Special color combinations. To determine what colors are available on your sign, see Appendix B.

3. 4. 1: Software operation

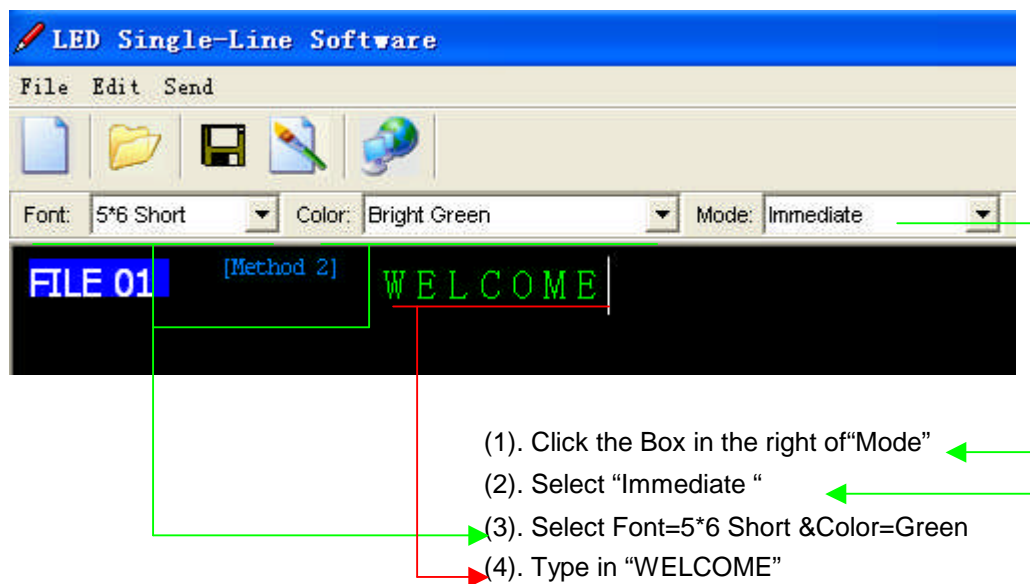

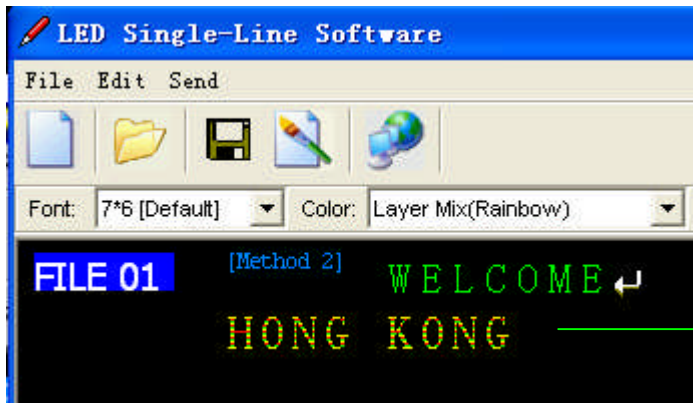

- (5). Select **Font=7*6** & **Color=Rainbow**
- Note: It turns on **Cyclic** again
- (6). Type in "HONG KONG"

3.4.2: Remote Control Operation

User can make method, font or color adjustment of the message. After enter the Edit Mode as 3.2.2, user should firstly press \rightarrow or \leftarrow key so as to enter into method, font or color can be chosen to display at the message.

Step	Keys to press	Explanation	Display
1.	PROG	Begin the edit program mode	OPEN:??
2.	01 ENT	This is the file number to assign to this new message file	[CYCLIC]
3.	MET PREV or NEXT	Assign the method of display to an Immediate	[IMMED]
4.	COL PREV or NEXT	Assign the color Green	[GRE]
5.	FONT PREV or NEXT	Assign the font =5*6 Short	[5×6]
6.	WELCOME	Enters in message text	WELCOME
7.	RUN	Exit out of edit message mode	SAVE? (Y/N)
8.	Y	Save the data file as 01	Message begins to be displayed

3.5: Example 5- Insert beep, speed or pause

Beep: Type of beep sound can be chosen during displaying on a sign.

Speed: Messages can be speeded up or slowed down. It is available for your sign, see Appendix

A.

Stay time: Generate a stay time within the programmed message, see Appendix A too.

3.5.1: Software operation

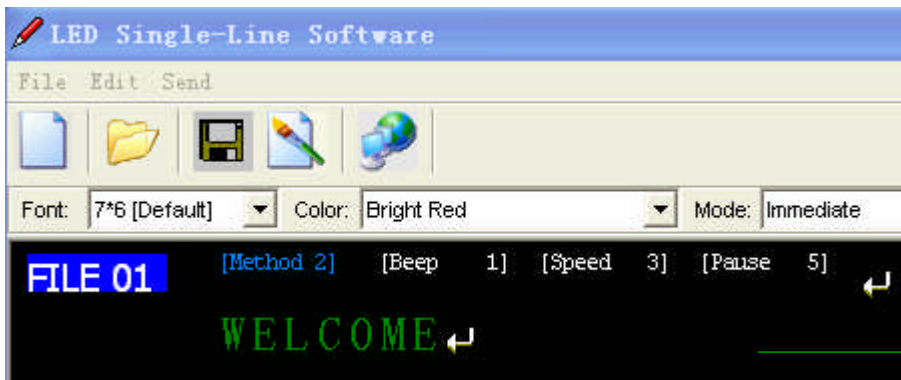

- (1) Right click the mouse
- (2) Insert **Beep 1**
- (3) Insert **Speed 3[default]**
- (4) Insert **Pause 5**

3.5.2: Remote Control Operation

User can insert beep, speed or pause of the message used by hand-held remote control.

Step	Keys to press	Explanation	Display
1	PROG	Begin the edit program mode	OPEN:??
2	01 ENT	This is the file number to assign to this new message file	[CYCLIC]
3	BEEP PREV or NEXT	Assign type of beep	[BEEP 1]
4	SPE PREV or NEXT	Assign type of speed	[SPEED 3]
5	PAU PREV or NEXT	Assign type of pause	[PAUSE 5]
6	WELCOME	Enter message text	WELCOME
7	RUN	Exit edit message mode	SAVE? (Y/N)
8	Y	Save the data file as 01	Message begins to be displayed

4: Advanced Messaging

4.1: Example 6-Setting time or date

4.1.1: Software operation

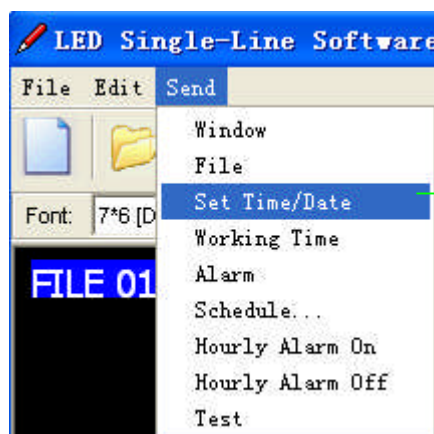

- (1) Update corrected time and date from PC clock.

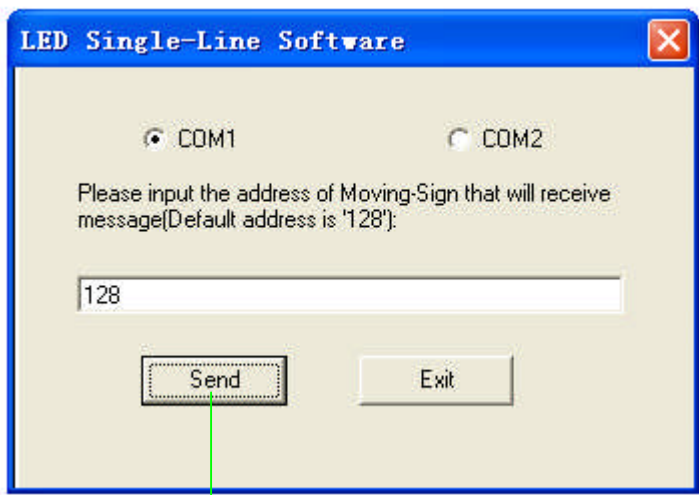

(2) Click “Send” to update the change.

4.1.2: Remote control operation

User can set time or date of the message used by hand-held remote control.

Step	Keys to press	Explanation	Display
1.	PROG	Begin the edit program mode	OPEN:??
2.	01 ENT	This is the file number to assign to this new message file	[CYCLIC]
3.	Time	Enter into time function mode	SET TIME
4.	ENT	Display current time	[00:00:00]
5.	← or →	Choose option of hour, minute or second	[--:--:--]
6.	PREV or NEXT	Modify hour, minute or second	[--:--:--]
7.	ENT	Confirm new time setting	[13:25:02]
8.	Time NEXT	Enter into date function mode	SET DATE
9.	ENT	Display current date	[SA 17 – 05-01]
10.	← or →	Choose option of year, month or day	[XX XX – XX - XX]
11.	PREV or NEXT	Modify year, month or day	[XX XX – XX - XX]
12.	ENT	Confirm new date setting	[TH 02 – 09-04]
13.	RUN	End the edit program mode	SAVE?(Y/N)
14.	Y	Save the message as data file number 01	Message begins to be displayed

4.2: Example 7- Programming filename messages in sequence

4.2.1: Software operation

In this example, it leverages the power of sequencing to achieve desired results. We’ll display messages by their files’ names (**FILE01**, **FILE03**) in certain order, and disappear at times you specified.

* Note: Displaying messages in time order will work only as long as the sign has power. When your sign loses power, its internal clock becomes inaccurate and must be reset again. (See 4.1.1)

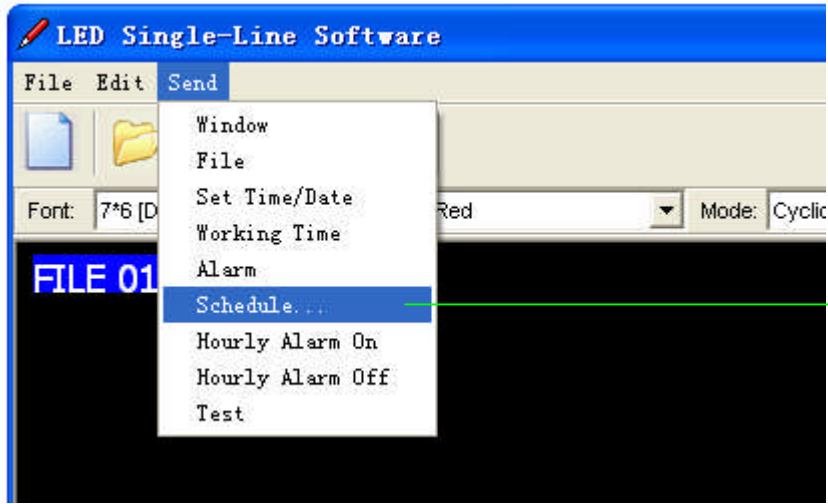

(1) Select **Schedule...**

(2) Select 0, totally there are 10 different kind of sequence files, from 0 to 9 , which you can specify.

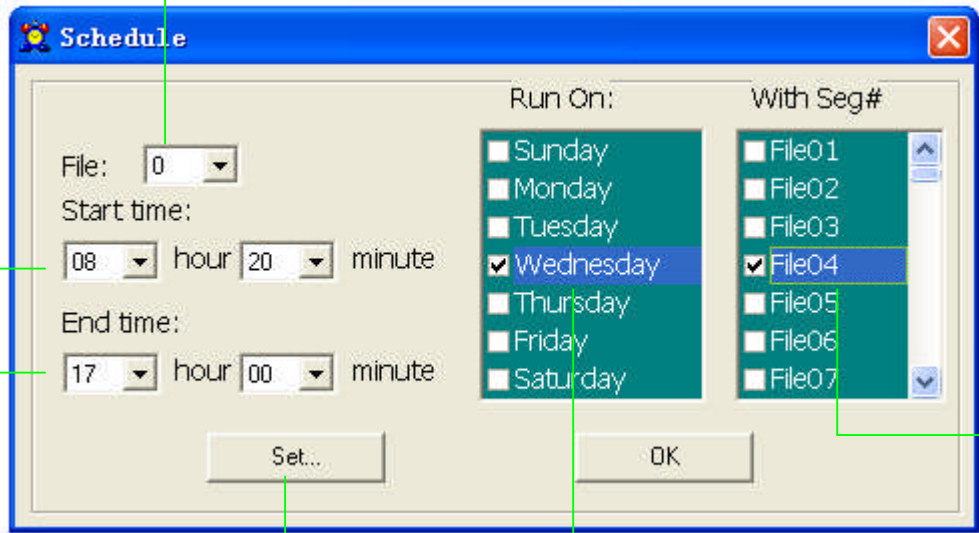

(5) Select File04

(6) Display on Wednesday ONLY.

(7) Click **Setting** to update the changes

(3) On time is 08:20

(4) Off time is 17:00

4.2.2: Remote control operation

Sequence files have special names that begin with the letter "S" followed by a single digit number(S0-S9). As such, there are only ten sequence files, which can be stored and retrieved by the sign. Let's say that as the owner of a restaurant named Box Car Express. You have daily specials that appeal to the lunch crowd at noon. You have already created the following files:

File Number	Message
10	Welcome to the Box Car Express
11	Today's special is
12	2-Pc. Chicken Meal with
13	Mashed Potatoes and Gravy.
14	Our drink Special is Diet Coke.

You may want to display the above messages from 10:00 am to 1:00 pm, Monday to Friday. In order to display the entire message, your sequence file would contain the line:
10 11 12 13 14

Step	Keys to press	Explanation	Display
1.	PROG	Begin the edit message mode	OPEN :??
2.	S	For sequential file	[S0]
3.	1 ENT	Enter sequential file number	DAY 0 1 2 3 4 5 6
4.	→	Move right	1 high lighted
5.	NEXT or PREV	Toggle for ON/OFF	1 in green with red background
6.		Repeat step 4 & 5 for 2, 3, 4, 5 until all 2, 3, 4, 5 in green color	
7.	S	Set start time	START 00:00
8.	NEXT or PREV	Change the start timer	The digit in green will be changed
9.	← or →	Use the arrow key for proper digit	
10.		Repeat steps 8 & 9 until display shown 10:00	
11.	S	Set stop time	END 23:59
12.		Repeat 8 & 9 until display shown 13:00	
13.	ENT	Confirm the time setting	S1
14.	10 11 12 13 14	This is the sequence of file numbers to display, separated by a space.	
15.	RUN	Exit the edit program mode	SAVE?(Y/N)
16.	Y	Save the sequence file as S1	Message begins to be displayed

The real advantage of sequencing files is the ability to change only one segment of a long message! If you decide to change the meal special but not the drink special, you need only edit file number 12.

In essence, sequencing saves your time from having to edit long messages when only minor changes are needed.

Please be reminded that once there is any sequence file and the time setting is valid, the sign will display the preset message starts from sequence file S0 through S9.

4.3: Example 8- Creating your own custom graphics & logo

4.3.1: Software operation

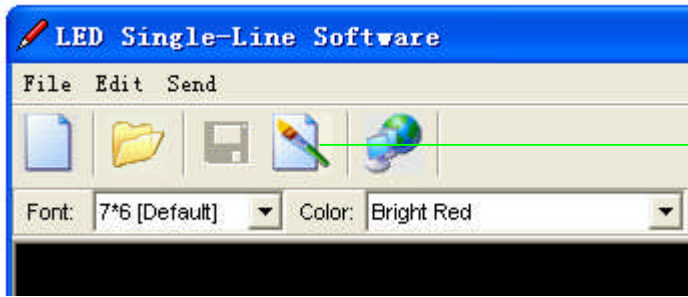

(1) Click **Lattice** icon to edit your graphic or logo.

Note: The maximum no. of user-defined graphics can be installed in the sign is 8, from graphic A – graphic H.

(2) Select the palette for different color.

(3) Create your graphics in this area.
 Note: The graphic will be automatically saved.
 Note: Click left mouse to draw dot by dot
 Note: Click right mouse to delete a dot.



(5) The total numbers of the graphics had defined by the user.

(6) The no. of the graphic that is editing now.

(4) The preview of graphic is the same as the content in the editing area.

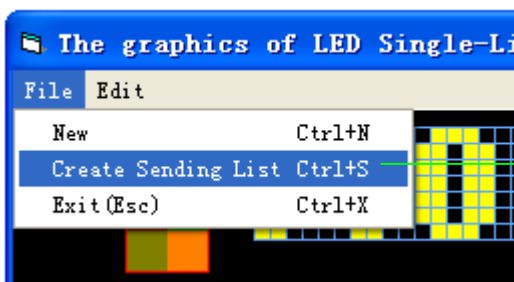

(7) Select Create Sending List to create your own graphic list

(8) Double click the graphic to add into the current graphic list
 Note: The maximum no. of user-defined graphics can be installed in the sign is 8, from **Graphic A- Graphic H**.

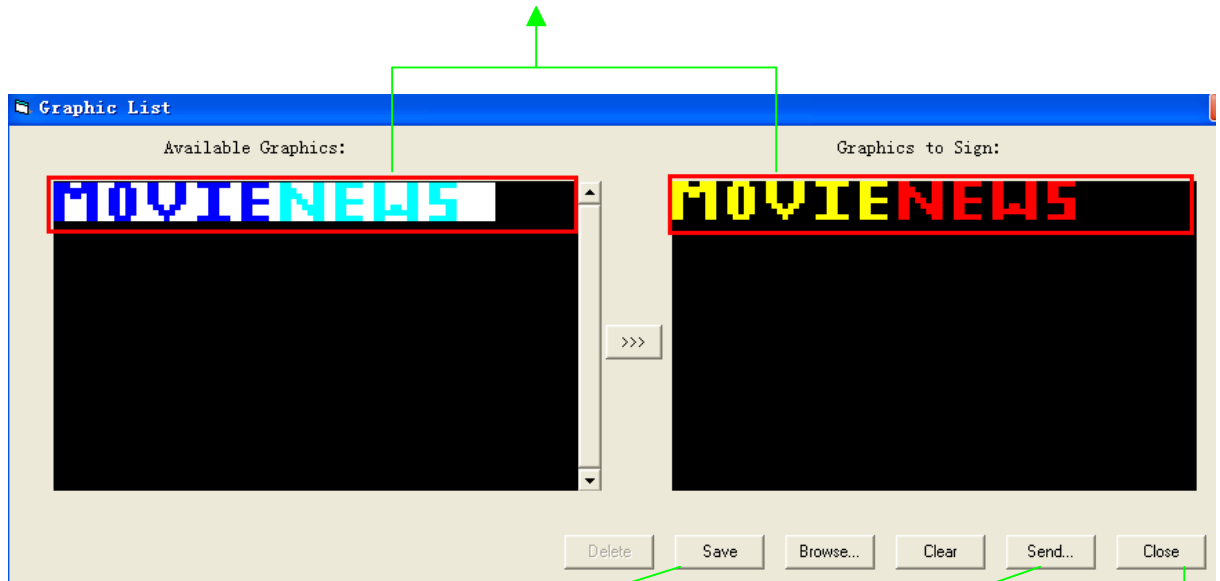

(9) Click **Save** to store the current graphic list as "lst" file.

(10) Click **Send...** to upload the current graphic list into the sign

(11) Close the window

Overview of screen layout

Name	Sub-menu	Description
File	Save as...	Save as another ISN number
	Create Sending List	⌘ Save all the custom graphics as a "lst" file. (Note: the maximum no. of user-defined graphics is 8) ⌘ Send the graphic list into the sign. (Note: the maximum no. of user-defined graphics can be installed into the sign is 8,
	Exit	Close the graphic editing window
Lattice	Create a new lattice	Create another graphic
	Editing old lattice	Open an old lattice for the editing
	Clear current lattice	Clear the current graphic

4.3.2: Remote control operation

User can make his own graphic by hand-held remote. Press key GRA to choose the appropriate option and after select specified memory location you want, the display only with a dot of cursor (when enter the MAKE GRAPH function). To edit the graph, user can press key G, H, L, P, O, N, J, F to move the cursor onto specified arrows directions, I.e. N, NE, E, SE, S, SW, W, NW respectively.

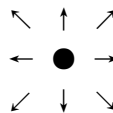

- **PREV** or **NEXT** key : Change the LED dot color continuously.
- **K** key : If user wants to draw a line, he can press the key and makes a line through the cursor position. To turn off the draw line function by press **K** key again.

4.4: Example 9- Displaying your own custom graphics & logo

4.4.1: Software operation

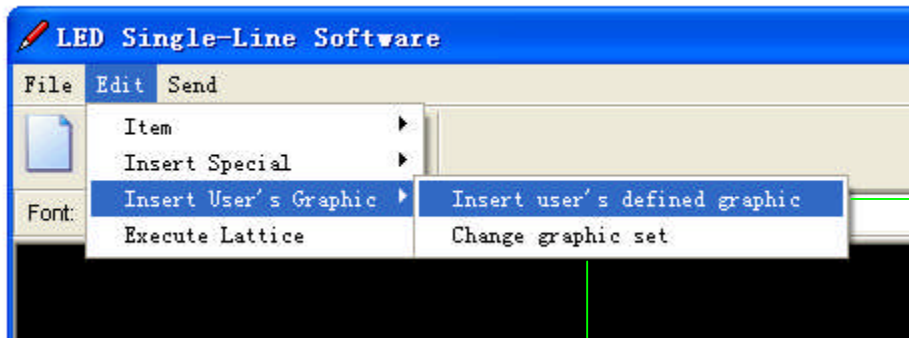

(1) Select **Insert user's defined graphic** to add your own graphic.

Note: Change graphic set is not applicable in this manual.



(2) Select your own graphic and then click **Insert**.



4.4.2: Remote control operation

In order to get a graphic for displaying between any messages, user should firstly enter the Edit mode at the desired location, press **GRA** and cycle through the functions and press **ENT** when the display shown "GET GRAPH". All preset graphics will cycle through with the key **PREV** or **NEXT** pressed. Press **ENT** for the right one.

5: Other Timer Options

5.1: Software operation

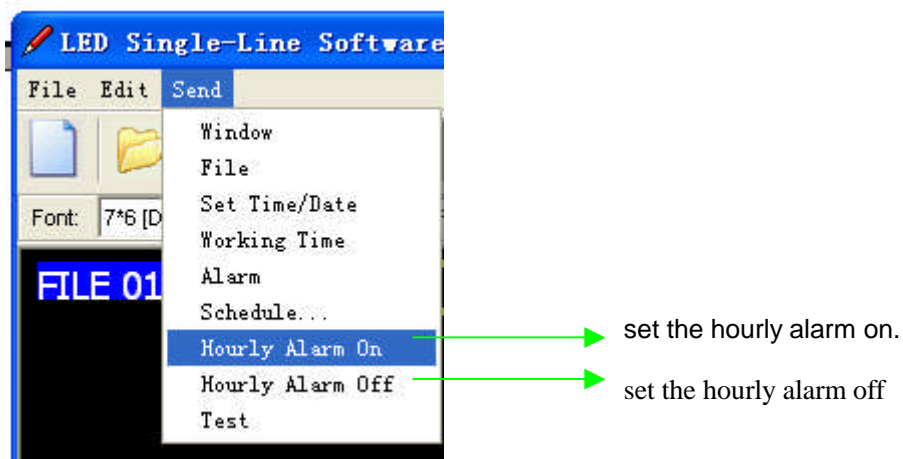
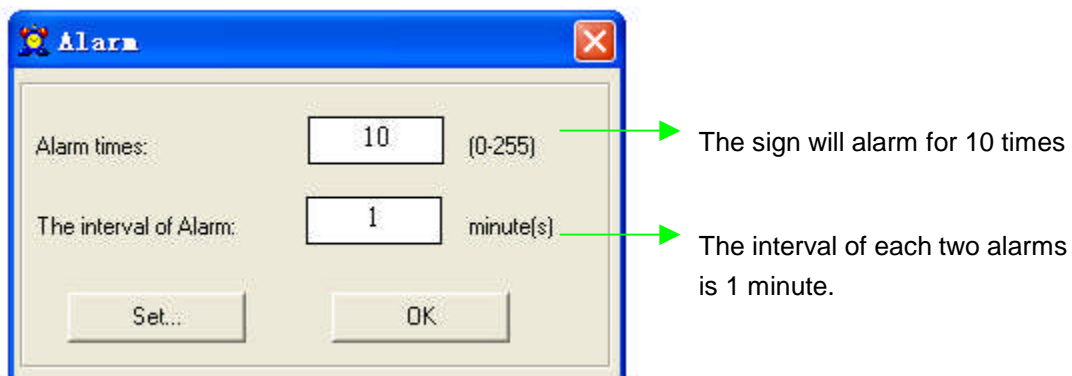

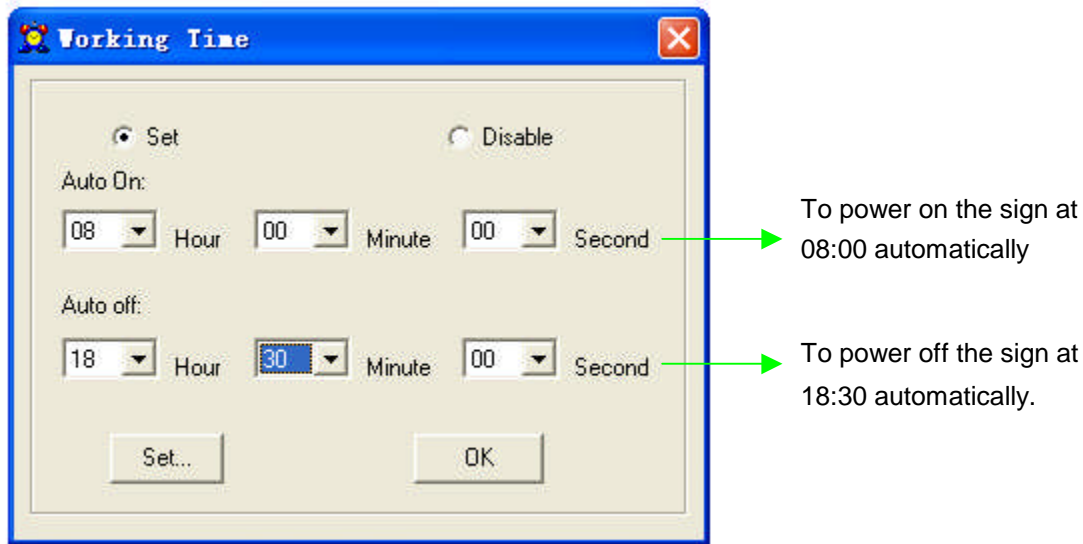

Note that: You may only set the timer functions while running your message sign.

5.2: Remote control operation

To select the timer function while in edit mode at the end of a message is fine, press the **TIME** key. Press the **NEXT** and **PREV** keys to cycle through the timer functions and press the **ENT** key to make your selection.

Function	Description
SET TIME	Adjust the Real Time Clock
SET DATE	Adjust the Date
ALARM	Set alarm times and interval
HOURLY ALARM	Set the hourly alarm On/Off
12H MODE	If selected, the time will be displayed in 12-hour format (Note: while programming, always enter the time in 24-hour format)
24H MODE	If selected, the time will be displayed in 24-hour format
ADD TIME	Add a time display screen in the data file
ADD DATE	Add a date display screen in the data file
OFF TIME	Tums off at the programmed time of day
ON TIME	Tums on at the programmed time of day

Additional Tips On Alarm Setting-

When you select the Alarm option, the sign will indicate C: XXXM: XXX. Where **XXX** is a number from **000** to **255**.

C is the total times of the alarm to be activated, and **M** is the time interval between two activations.

Example-

C: 123M: 001 - this means that there will be 123 times of alarm signal, and the time interval between each alarm signals will be 1 minute.

Note that: You may only set the timer functions while running your message sign.

Appendix A: Additional Programming Tips

Function Code	Definition	Possibilities	Control
METHOD	Display Option	Cyclic	[CYCLIC]
		Immediate	[IMMED]
		Open from Right	[OPEN←]
		Open from Left	[OPEN→]
		Open from center	[OPEN<>]
		Open to Center	[OPEN><]
		Cover from Center	[COVER<>]
		Cover from Right	[COVER←]
		Cover to Left	[COVER→]
		Cover to Center	[COVER><]
		Scroll Up	[SCROLL ↑]
		Scroll Down	[SCROLL ↓]
		Interlace to Center	[INTER><]
		Interlace to Cover	[INCOVER><]
		Cover Up	[COVER ↑]
		Cover Down	[COVER ↓]
		Scan Line	[SCANLN]
		Explode	[EXPLOED]
		Pac Man	[PACMAN]
		Pall & Stack	[FALL]
Shoot	[SHOOT]		
Flash	[FLASH]		
Random	[RANDOM]		
Slide in	[SLIDE IN]		
	Auto (Note: It is appeared in window software only, but not available in remote control.)	[AUTO]	
COLOR	Alters the color of text	See Appendix B	
FONT	Changes the shape and size of characters	5×6 Short	[5×6]
		5×11 Short & Wide	[5×11]
		7×6 (Default)	[7×6]
		7×11 Wide	[7×11]
		7×9	[7×9]
		7×17 Extra Wide	[7×17]
		Small Fonts	[Small]

SPEED	Change the scrolling speed of the display	Speed 1(Fastest)	[SPEED 1]
		Speed 2	[SPEED 2]
		Speed 3	[SPEED 3]
		Speed 4	[SPEED 4]
		Speed 5	[SPEED 5]
		Speed 6	[SPEED 6]
		Speed 7	[SPEED 7]
		Speed 8(Slowest)	[SPEED 8]
GRAPHICS	Editable by user		[GRAPH A]
			[GRAPH B]
			[GRAPH C]
			[GRAPH D]
			[GRAPH E]
			[GRAPH F]
			[GRAPH G]
			[GRAPH H]
	Non- editable by user	City	[GRAPH I]
		Car	[GRAPH J]
		Vessel	[GRAPH K]
		Tel	[GRAPH L]
		Nature	[GRAPH M]
		Ship	[GRAPH N]
Swim		[GRAPH O]	
Cat	[GRAPH P]		
PHRASE	Generate an animated pre-programmed display	MERRY X' MAS	[ANIM1]
		HAPPY NEW YEAR	[ANIM2]
		4 TH JULY	[ANIM3]
		HAPPY EASTER	[ANIM4]
		HAPPY HALLOWEEN	[ANIM5]
		DON'T DRINK & DRIVE	[ANIM6]
		NO SMOKING	[ANIM7]
		WELCOME	[ANIM8]
PAUSE	Generate a pause within the programmed message	Pauses for 2second delay	[PAUSE1]
		Pauses for 3second delay	[PAUSE2]
		Pauses for 4second delay	[PAUSE3]
		Pauses for 6second delay	[PAUSE4]
		Pauses for 10second delay	[PAUSE5]
		Pauses for 20second delay	[PAUSE6]
		Pauses for 30second delay	[PAUSE7]
		Pauses for 60second delay	[PAUSE8]

Appendix B : Listing Of Color

Color Name	Display Code
Red	[RED]
Bright Red	[RED] *
Orange	[ORA]
Bright Orange	[ORA] *
Yellow	[YEL]
Bright Yellow	[YEL] *
Green	[GRE]
Bright Green	[GRE] *
Layer Mix(Rainbow)	[MIX]
Bright Layer Mix(Rainbow)	[MIX] *
Vertical Mix	[MIX]
Saw Tooth Mix	[MIX]
Green on Red	[MIX]
Red on Green	[MIX]
Orange on Red	[MIX]
Yellow on Green	[MIX]

⌘ The color of the dots will not change, except the brightness

Appendix C: Listing Of International Characters

English Character	International Characters
A	À Á Â Ã Ä Å Æ
C	Ç Ç
E	É Ê Ë Ì Í Î Ï
N	Ñ Ò Ó
O	Ö
S	Š Š
U	Ü Ü Ü Ü
Z	Ž Ž
a	â ä à á æ á
c	ç
e	é ê ë è é
i	ï ï ï
n	ñ ñ
o	ô õ ò ó ò
t	
u	ü ü ü ü
y	ÿ
Space	α β γ π Σ σ μ τ φ θ Ω ∞ δ φ
?	¿
\$	¢ £ ¥ Pt □ €

Appendix D: Listing Of Symbol Characters

Note: The actual symbol appear in brackets (“[]”) during the programming mode

Sunny	Cloudy	Rainy	Clock
Phone	Glasses	Faucet	Rocket
Alien	Key	Sweater	Helicopter
Car	Tank	House	Teapot
Trees	Duck	Motorcycle	Bike
Crown	Hearts	Right Arrow	Left Arrow
Lower Left Arrow	Upper Left Arrow	Mug	Chair
Shoe	Martini Glass		

Appendix E: Change Password

Step	Keys to press	Explanation	Display
1.	PROG	Enter Edit mode	OPEN: ??
2.	00 ENT	Enter file 00	OLDFIL [CYCLIC]
3.	Press → while ALT is being hold	Fast shift	
4.	Repeat step 3	A few times until you reach to the end of the file, this is to make sure you will not modify the content of the file while doing password change	
5.	CPW	Enter password mode	UNUSE PASS
6.	NEXT		USE PASS
7.	NEXT		RES PASS
8.	NEXT	Change password	CHANGE: ***
9.	AAA ENT	Change the password to AAA	AGAIN: ***
10.	AAA ENT	Confirm the password	You have changed the password to AAA .

*** Note: If for any reason the password is lost or forgotten, you must access the DIP switch in the back of the sign unit (not the remote control) and move Switch 8 to ON.

Troubleshooting

No display	<ul style="list-style-type: none"> -Check if the power socket located at the back of the sign is connected. -Check if the AC power plug is plugged into the wall outlet. -Check if the main power of the AC outlet is normal.
Not response to remote control	<ul style="list-style-type: none"> -Check if the batteries of the remote control still have enough energy. If user is not sure, please replace all the batteries. -Check if the batteries of the remote control are placed at right polarity. Please follow the markings in the battery compartment. -Check if there is anything between the remote and the sign blocking the remote
No display but response to the remote control	<ul style="list-style-type: none"> -Check if the auto on/auto off time setting is correct. -Check if the data in the files are valid. -If you are not sure, you can enter the edit mode and press 'CLR' key of the remote control, select 'DEL ALL' to erase all data, this will reset the sign to display the default demo messages.
If the above procedures do not work, please contact your dealer.	

*Remarks: When edit Turkey characters, after press **C** you just need to press*

***NEXT** and the other characters will take on.*