

RD *Power Dynamics* *Professional Audio*

PDV-series Public Address Zone Amplifiers



952.060 PDV060Z 60W/100V

952.063 PDV120Z 120W/100V

952.066 PDV240Z 240W/100V



SAFETY INSTRUCTIONS



The symbol is used to indicate that some hazardous live terminals are involved with in this apparatus, even under the normal operating conditions.



The symbol is used in the service documentation to indicate that specific component shall be only replaced by the component specified in that documentation for safety reasons.

-  Protective Ground Terminal
-  AC mains (Alternating Current)
-  Hazardous Live Terminal

ON: Denotes the apparatus turns on.

OFF: Denotes the apparatus turns off, because of using the single pole switch, be sure to unplug the AC power to prevent any electric shock before you proceed you service.

WARNING:

Describes precautions that should be observed to prevent the danger of injury or death to the user.



Disposing of this product should not be placed in municipal waste and should be separate collection.

CAUTION:

Describes precautions that should be observed to prevent damage to the apparatus.

WARNING

• Power supply

Ensure the source voltage matches the voltage of the power supply before turning ON the apparatus. Unplug this apparatus during lightning storms or when unused for long periods of time.

• External Connection

The external wiring connected to the output hazardous live terminals requires installation by an instructed person, or the use of ready-made leads or cords.

• Do not Remove any Cover

There are maybe some are as with high voltages inside, to reduce the risk of electric shock, do not remove any cover if the power supply is connected.

The cover should be removed by the qualified personnel only.

No user serviceable parts inside.

• Fuse

To prevent a fire, make sure to use fuses with specified standard (current, voltage, type). Do not use a different fuse or short circuit the fuse holder. Before replacing the fuse, turn OFF the apparatus and disconnected the power source.

• Protective Grounding

Make sure to connect the protective grounding to prevent any electric shock before turning ON the apparatus. Never cut off the internal or external protective grounding wire or disconnect the wiring of protective grounding terminal.

• Operating Conditions

This apparatus shall not be exposed to dripping or splashing and that no objects filled with liquids, such as vases, shall be placed on this apparatus. To reduce the risk of fire or electric shock, do not expose this apparatus to rain or moisture.

Do not use this apparatus near water. Install in accordance with the manufacturer's instructions, Do not install near any heat sources such as radiators, heat registers, stoves, or other apparatus (including amplifiers) that produce heat. Do not block any ventilation openings. No naked flame sources, such as lighted candles, should be placed on the apparatus.

IMPORTANT SAFETY INSTRUCTIONS

- Read these instructions
- Follow all instructions
- Keep these instructions
- Heed all warnings
- Only use attachments / accessories specified by the manufacturer
- Power cord and plug
Do not defeat the safety purpose of the polarized or grounding type plug. A polarized plug has two blades with one wider than the other. A grounding type plug has two blades and a third grounding prong. The wide blade or the third prong are provided for your safety. If the provided plug does not fit into your outlet, consult an electrician for replacement of the obsolete outlet. Protect the power cord from being walked on or pinched particularly at plugs, convenience receptacles, and the point where they exit from the apparatus.

• Cleaning

When the apparatus needs a cleaning, you can blow off dust from the apparatus with a blower or channel with rag etc.

Don't use solvents such as benzol, alcohol, or other fluids with very strong volatility and flammability for cleaning the apparatus body, Clean only with dry cloth.

• Servicing

Refer all servicing to qualified personnel, To reduce the risk of electric shock, do not perform any servicing other than that contained in the operating instructions unless you are qualified to do so.

Servicing is required when the apparatus has been damaged in any way, such as power supply cord or plug is damaged, liquid has been spilled or objects have fallen into the apparatus, the apparatus has been exposed to rain or moisture, does not operate normally or has been dropped.

GENERAL DESCRIPTION AND FEATURES

DESCRIPTION

They are designed for PA system applications such as paging, announcements, intercommunications, background music and broad-casting in industrial plants, offices, schools, churches, department stores, shopping centres, night clubs, dining rooms, convention halls, auditoriums and recreation areas.

More kinds of protective for this series: such as overload, short-circuits of output, overheat; and you can use it safety and freely. It's very simple to install, it also can offer therack brackets according to your requirements.

The series amplifiers come with 3 MIC inputs, 3 inputs LINE / MIC PHONE selectable switch, 1 auxiliary inputs and 1 AUX. OUTPUT and 1REC OUT. Microphone inputs may be used with unbalanced microphone. Auxiliary inputs are provided for high level signal sources such as radio tuner, tape recorder, mixer pre amplifier, remote microphone and record player with ceramic or crystal type cartridge. Speaker outputs are complete with 4ohm, 8 ohm, 70V and 100V on the terminal strip. An auxiliary output is equipped for a booster amplifier and a AUX output is equipped for a tape Recorder.

Each input volume can be controlled with the corresponding individual input volume control and can further be adjusted by means of a master volume control and individual bass and treble tone controls, Emergency operation can be made by DC 24V power source, even in case of AC power failure.

FEATURES

- Three MIC inputs.
- Three inputs with line / mic selectable
- One AUX input.
- One AUX output.
- One record output.
- Four Zone paging select switches, and one all Zone select switch.
- INPUT1 mute other inputs.
- Each channel has the input level control.
- Master volume control.
- BASS and TREBLE tone control.
- Multi-purpose protection---power-on-delay, over heat, over voltage, over load.
- Output---4 Ω , 8 Ω , 70V, 100V.
- Low distortion.
- High signal-noise rated(S/N).
- Widely frequency response.
- Perfect sound with PA speaker.

FRONT PANEL

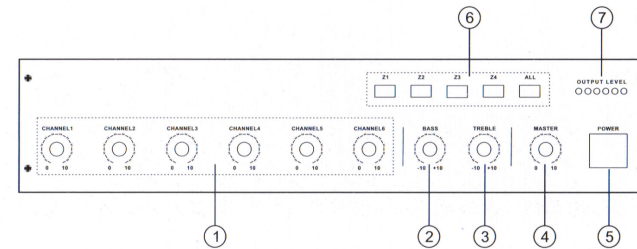

1. INPUT VOLUME CONTROL

When it is 0 dB, the volume is lowest; it is 10dB, the volume is highest.

2. COMMON BASS-CONTROL

When turned clockwise this control enhances the low frequency reproduction, while turning it counter-clockwise attenuates the bass frequencies, If the control is set to its center position, the overall frequency response is not being altered

3. COMMON TREBLE-CONTROL

When turned clockwise this control enhances the high frequency reproduction, while turning it counter-clockwise attenuates the treble frequencies, If the control is set to its center position, the overall frequency response is not being altered

4. MASTER CONTROL

This knob is used to control main power.

5. POWER SWITCH

This switch is used to turn the main power ON and OFF.

6. PAGING BROADCAST SWITCH

This switch is used to select zone paging broadcast.

7. LED VU-METER INSTRUMENTS

This instrument shows the signal's output level, For proper operation of the amplifier correct Volume setting of major importance. The first LED will illuminate when power is turned on.

REAR PANEL

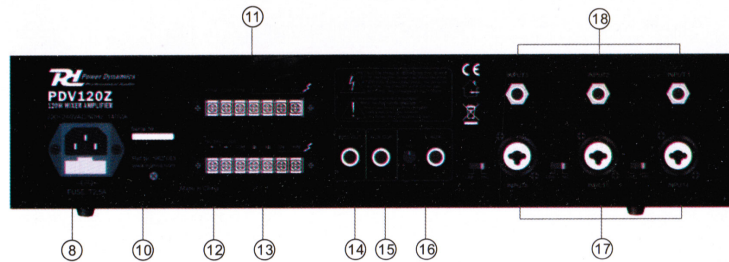

8. AC CONNECTOR AND AC FUSE

This connector is meant for the connection of the supplied mains cord. The fuse protects the alternating currents supply circuit of the equipment. The fuse can only be changed in the event of a fault.

9. VOLTAGE SWITCH

This switch is used to select voltage (115V / 230V) as requirement (not for all models).

10. "GND" SCREW

In case the used mains outlet does not provide a ground conductor, this screw offers the possibility to ground the amplifier metal parts. Nevertheless, you should leave this procedure to the experienced qualified electrician.

11. ZONE OUTPUT TERMINAL

This output terminal connects to the speaker lines, Total speaker wattage is up to nominal power for zones 1-4. When using a zone selector low-impedance speakers can not be used, default is constant voltage 100V output.

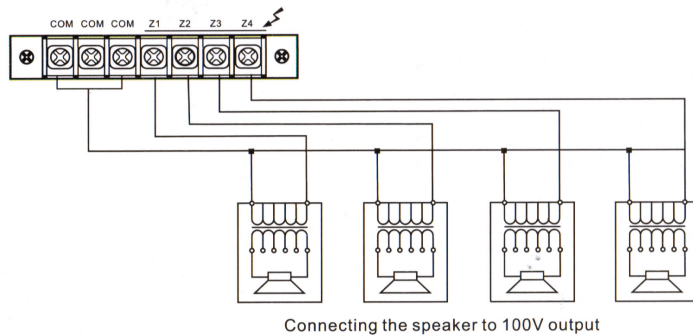

12. DC BATTERY SUPPLY

These two terminals allow the connection of an external 24V DC power supply (e.g 24v DC battery). In this way continuous operation of the amplifier is maintained even during a power outage. Since it is automatically switched to the DC power source.

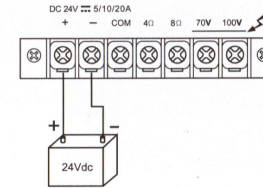

13. OUTPUT TERMINALS

These 7 terminals allow connecting speakers.

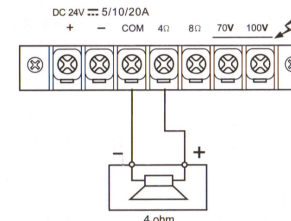

Connecting the speakers to 4 ohm output

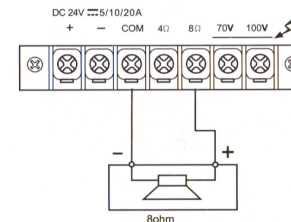
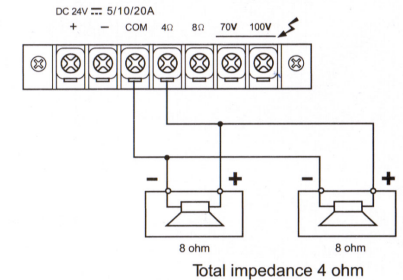

Connecting the speakers to 8 ohm output

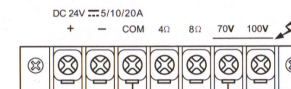
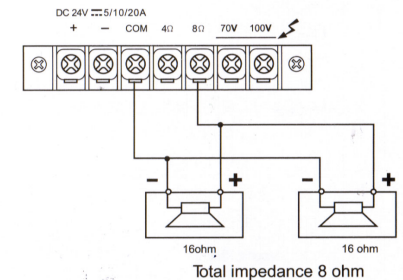

Connecting the speakers to 70V output

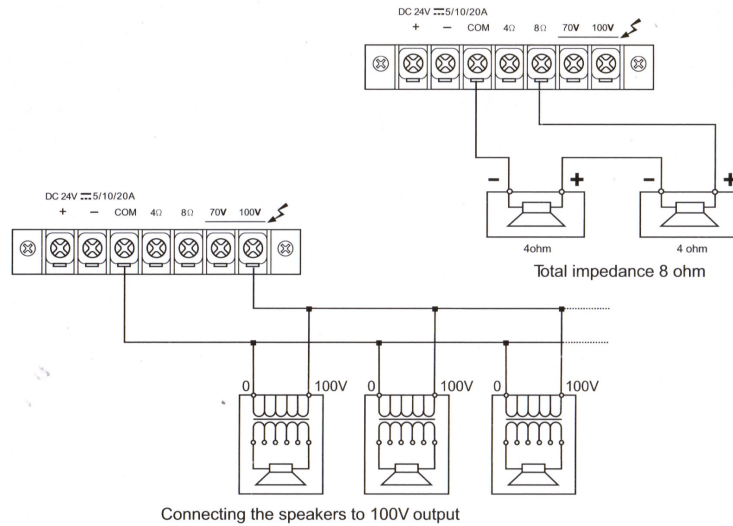

14. REC OUT

It is connected to tape recorder.

15. AUX OUT

The output only for the AUX signal.

16. AUX INPUT AND VOLUME ADJUSTMENT

The input of an audio source with a high-level output signal, such as an AM/FM tuner, a cassette deck, a CD player, etc.

17. "INPUT 4" "INPUT 5" AND "INPUT 6" INPUTS SENSITIVITY SWITCH AND MIC/LINE INPUTS

By turning these switch onto the "LINE" position the "IN4", "IN5", "IN6", input can be connected to an audio source with high level signal output. By turning these switches onto the "MIC" position the "IN4", "IN5", "IN6", input can be connected to a microphone with low impedance.

18. "INPUT 1" "INPUT 2" AND "INPUT 3"

It is used for MIC inputs.

TECHNICAL SPECIFICATION

OUTPUT POWER CAPACITY	RMS: 60W / 120W / 240W
POWER SUPPLY	AC: 110-120V 50/60Hz AC: 220-240V 50/60Hz
FREQUENCY RESPONSE	50Hz~18KHz (±3dB)
INPUT SENSITIVITY	MIC : -50dB LINE : -16dB AUX : -16dB
TONE CONTROLS	BASS: ±10dB (100Hz) TREBLE: ±10dB (10KHz)
TOTAL HARMONIC DISTORTION	<0.5%
SIGNAL / NOISE RATIO	MIC: 65dB AUX / LINE: 75dB
CONTROLS	MIC LEVEL CONTROL AUX LEVEL CONTROL TONE CONTROL (BASS, TREBLE) MASTER CONTROL ZONE SWITCH AC SWITCH
OUTPUT IMPEACANCE	4Ω, 8Ω
LINE OUTPUT	70V, 100V
SIREN FUNCTION	NO
VU-METER(LED)	YES
TELEPHONE PAGING LEVEL FUNCTION	NO
INPUT 1 PRIORITY	YES
CHIME FUNCTION	NO
AM / FM RADIO	NO
MP3 PLAYER	NO
DIMENSION	420X280X88.8mm / 420X320X88.8mm

EXAMPLE OF POSSIBLE CONNECTIONS

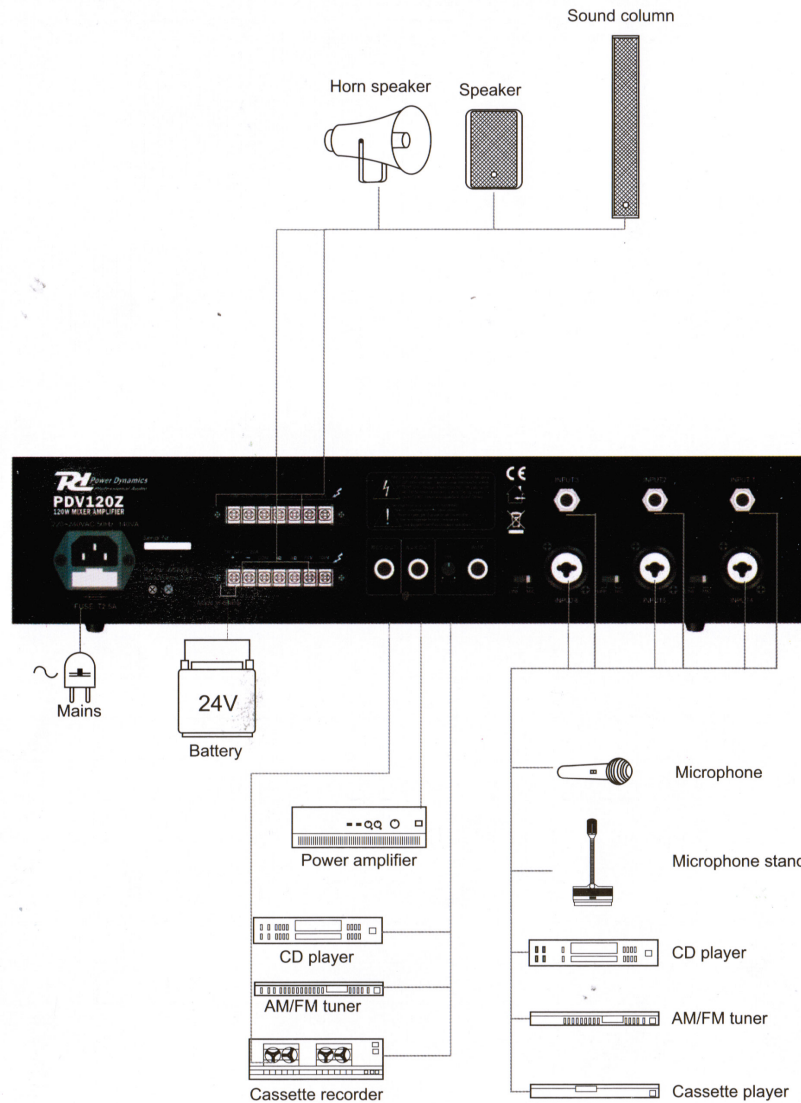

CE Declaration of Conformity

Importer: TRONIOS BV
 Bedrijvenpark Twente 415
 7602 KM – ALMELO
 The Netherlands
 Tel : 0031546589299
 Fax : 0031546589298

Product number: 952.060, 952.063, 952.066

Product Description: PDV060Z Zone Amplifier 60W / 100V
 PDV120Z Zone Amplifier 120W / 100V
 PDV240Z Zone Amplifier 240W / 100V

Regulatory Requirement: EN 60065
 EN 55013
 EN 55020
 EN 61000-3-2
 EN 61000-3-3

The product meets the requirements stated in the above mentioned Standards.

13-12-2012

Signature :