

# USB Temperature and Humidity Data Logger Instruction Manual

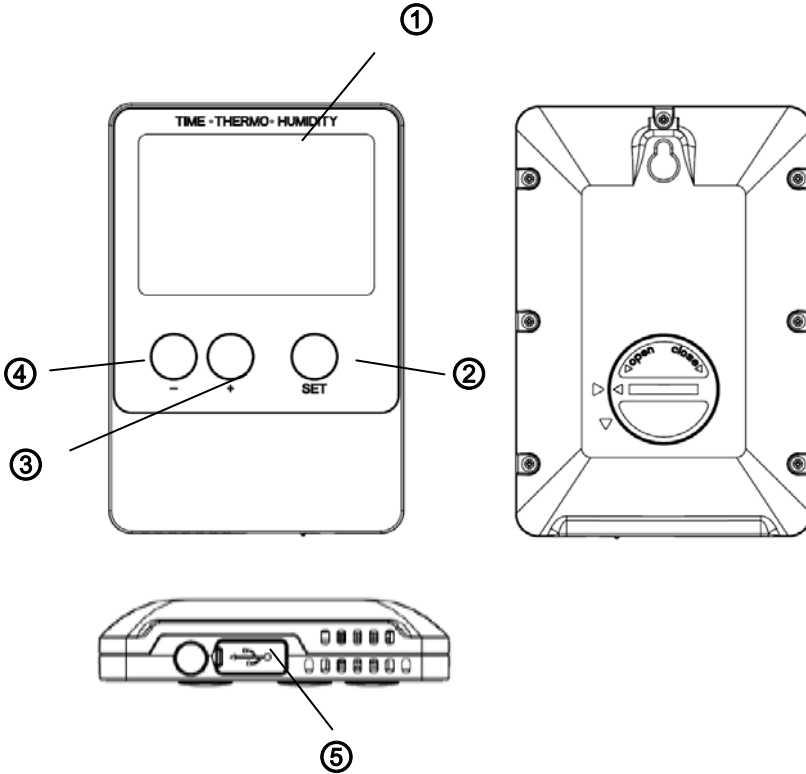

- 1. Display
- 2. Set key
- 3. + key
- 4. - key
- 5. USB port

1. Temperature
2. MAX/MIN value
3. Humidity
4. Memory status
5. Logging mode icon
6. Time period icon
7. Time/Date/Interval/year
8. Low battery indicator

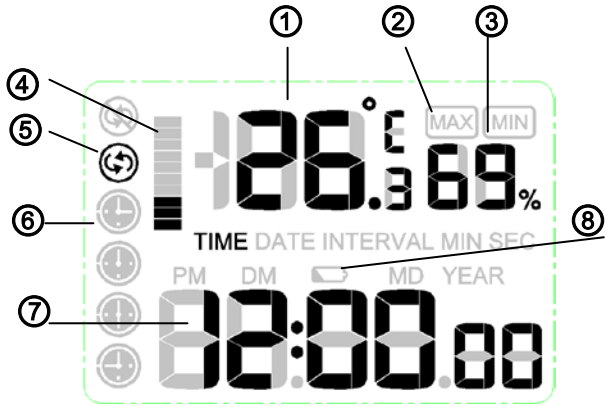

## 1. Introduction

Thank you for choosing this item for your data logging requirement. Small simple and affordable, data logger can measure and record data at specified intervals ranging from once every 8 seconds to once every 4hours. It is our goal to bring you accurate, low-cost, easy-to use data logger that integrate easily into the user's working environment.

### 1.1 Package Contents

- 1x data logger unit
- 1x USB cable
- 1x CD ROM
- 1x 3 V lithium battery CR2032
- Instruction manual

### 1.2 Features:

- Water resistance
- Measure and log temperature and humidity data
- Instant data download with PC/laptop
- USB interface for set-up and data download

- Easily re-configurable using included software
- Selectable logging intervals from 8 seconds to 4 hours (default 5 minute)
- Selectable measurement in °F or °C
- Time, date and unit synchronized your PC
- Low battery indicator

## 2. Installation

### 2.1 Insert battery

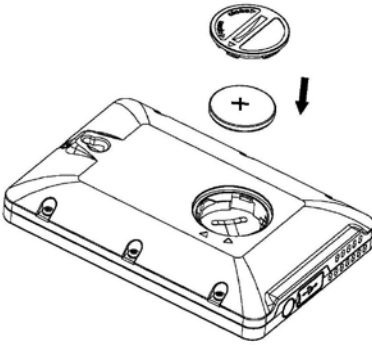

- 1). First use a large coin to open the battery cover at the back of the unit.
- 2). Checking the correct polarization, insert 1 x 3V (CR2032) lithium cell, positive (+) pole up, into the battery compartment and replace the cover.
- 3). When the battery is inserted, the LCD display turns on for about 3 seconds then enter to normal mode.

**Caution:** Do not reverse polarity of the batteries

### 2.2 Wall amount

You can mount this item on a wall by using a screw (not included)

## 3. Button Function:

### “SET” BUTTON:

- In normal display, press “SET” button to alternate between display of time, date and logging intervals
- In normal display, press “SET” button for 2 seconds to enter setting mode
- In normal display, press SET and ADD buttons at the same time for 5 seconds to enter Calibration mode

### “+” BUTTON:

- In normal display, press “+” button to alternate the display of Max, Min and current temperature & humidity
- In setting mode, press “+” button to increase the value of information being set.
- In Max/Min mode, press “+” button for 2 seconds, the Max or Min value will be reset to current reading

#### **“-” BUTTON:**

- In normal display, press “-” button for 2 seconds to clear the history data
- In setting mode, press “-” button to decrease the value of information being set.

## **4. Program Mode**

There are six program modes: Quick Display Mode, Setting Mode, Max/Min mode, Sleep Mode, Calibration mode and Data Logging mode.

### **4.1 Quick Display Mode**

While in Normal Mode, press the “SET” button to enter the Quick Display Mode as follows

- 1) Display time
- 2) Display date
- 3) Logging interval

### **4.2 Setting Mode**

While in Normal Mode, press the “SET” button for 2 seconds to enter Set Mode. The first setting will begin flashing. You can press the “SET” button again to skip any step, as defined below.

- 1) 12/24 hour format
- 2) Manual time setting (hour/minutes)
- 3) Date setting(DD-MM/MM-DD)
- 4) Calendar setting (year/month/date)
- 5) Temperature display unit degree Celsius or Fahrenheit
- 6) Logging interval setting from 8 seconds to 4 hours (default 5minute)

The temperature and humidity data will be measured per 60 seconds as default and be stored according to the logging interval. If the interval is set to a number less than 60seconds, both the temperature and humidity data will be measured and stored according to the logging interval time.

**Note:** In the setting mode, press “+” or “-” buttons to change or scrolls the value. Hold the button for 2 seconds can change fast.

**Note:** The setting mode will return to normal display while button idle 30s

### 4.3 MAX/MIN Mode

While in Normal mode, press "+" button to enter the MAX mode, and the Max icon and maximum records will be displayed

Press "+" button again to enter the MIN mode, and the MIN icon and minimum records will be display

Press "+" button again to return the Normal mode

While in Max or Min mode, press "+" button for 2 seconds, the Max or Min value will be reset to current reading

**Note:** Press "SET" button or wait 30 seconds, and the MAX/MIN Mode will return to normal mode.

### 4.4 Sleep Mode

If LCD "AUTO OFF" function was chosen on the PC software, the device will automatically enter sleep mode if no button is pressed for 10 minutes to save battery life. Press any button to exit sleep mode.

In Sleep Mode, the unit detects temperature and humidity data as Normal Mode.

### 4.5 Calibration Mode

While in Normal Mode, press "SET" and "+" buttons at the same time for 5 seconds to enter Calibration Mode. The temperature value will begin flashing. Press the "+" button or "-" button to increase or decrease the temperature bias to match the calibrated source. Press the "SET" key, the humidity value will begin flashing. Press the "+" button or "-" button to increase or decrease the humidity bias to match the calibrated source.

#### 4.5.1 Temperature calibration

To calibrate temperature, we recommend a mercury or red spirit (fluid) thermometer. Bi-metal (dial) and other digital thermometers are not a good source and have their own margin of error. Using a local weather station in your area is also a poor source due to changes in location, timing (airport weather stations are only updated once per hour) and possible calibration errors (many official weather stations are not properly installed and calibrated)

## 4.5.2 Humidity calibration

To calibrate humidity, you will need an accurate source, such as a sling psychrometer.

## 4.6 Logging Mode

The logging mode to be set on the PC software.

There are three types of logging mode: Cycle Mode, Acyclic Mode, and Segmented Mode.

The default mode is cycle Mode.

### 4.6.1 Cycle Mode

If select the Cycle Mode, the icon  will be displayed

In Cycle mode, when the memory is full, the oldest data sets stored will be overwritten by the new ones entered.

### 4.6.2 Acyclic Mode

If select the Acyclic Mode, the icon  will be displayed

In Acyclic Mode, when the memory is full, logging stops. Logging will continue when memory is cleared via the PC software.

### 4.6.3 Segmented Mode:

You can set max. 4 time periods through the setting menu on the PC software. These periods can't be overlapped. The time period must be later than current time. It will start logging from the set start time and stop from the set end time in a time period.

### Time period icon



Time period 1



Time period 2





Time period 3



Time period 4

If time period was selected, the time period icon circle frame  will be displayed

During the logging period, the time period icon inside  will be flashing

If memory is full or out of the period range, the time period icon  will displayed

**Note:**

If the logging mode is changed, the history data in data logger will be cleared automatically. Please download the data to PC before you change the logging mode.

Press and hold the “+” button, it will indicate “CLEAR” on the screen and the memory icon will flash, which means ready for clearing history record.

## **4.7 Other Features**

### **4.7.1 History Clear**

While in Normal Mode, press and hold the “-” button for 2 seconds, it will indicate “CLEAR” on the screen and the history data will be cleared.

### **4.7.2 Memory Status:**

There are 10 bar graphs to indicate the memory store capacity. One bar graph is indicating 10% memory. The history data and the previous settings of the logger won't lose when battery is changed.

### **4.7.3 Low Battery Condition**

When the battery voltage is under proper operation requirement the **XX** symbol will show on the LCD and the battery need to be replace with new one.

## **5. Software**

### **5.1 System requirements**

To install the software onto your PC, the minimum requirements are as follows:

Operating System: Windows XP, Windows Vista, windows7, windows 8

Internet Explorer 6.0 or above

Processor: Pentium III 500 MHz or above  
Memory: at least 128MB, 256MB recommended  
CD-ROM Drive  
Data logger and PC must be connected by USB cable

### 5.2 Installation of the Software

1. Switch on your PC and insert the CD-ROM into the CD-ROM Drive.
2. Double click “DataLogger.exe”
3. Choose the language and then install the “DataLogger.exe” on your PC.

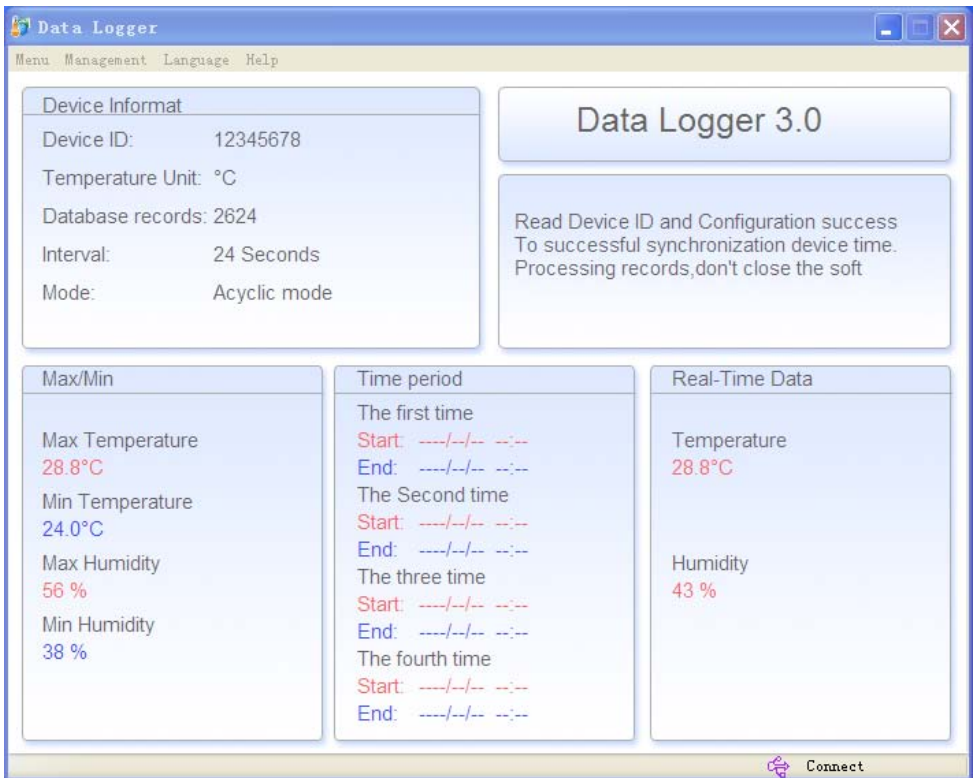

### 5.3 Basic Settings of the “USB Datalogger” Software

After the “Datalogger” program has been started, the following main window will appear on the PC screen:





Insert the Data Logger into the USB port of your computer. While data logger connected to PC successfully, the data will be uploaded to PC automatically and the icon of

 **Connect** will be displayed. Otherwise the  **Unconnect** will be displayed.

It will generate a unique Device ID for each data logger.

**Tool Bar:** The tool bar at the top of the screen has 4 options; Menu, Management, Language and Help.

### Menu option

Click setup button, enters the Setup menu

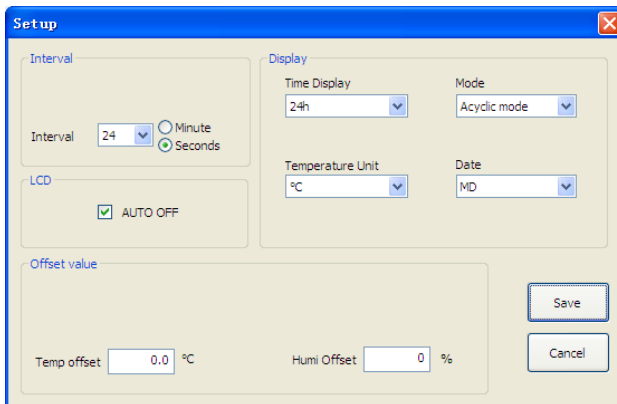
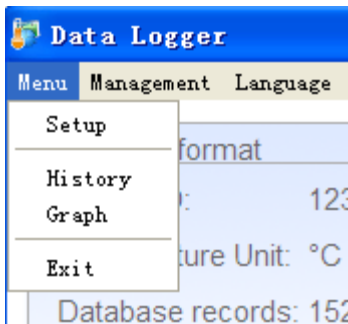

**Interval:** 8 Seconds to 240minutes

**Time display:** Set Time display as 12hours or 24 hours mode.

**Mode:** Set the logging mode among Cycle Mode, Acyclic Mode, and Segmented Mode..

**Temperature unit:** Set the device to read in either Celsius (C°) or Fahrenheit (F°)

**Date Format:** Set the date format in DM or MD.

**LCD:** If LCD "AUTO OFF" function was chosen, the device will automatically enter sleep mode while no button is pressed for 10 minutes to save battery life. Press any button to exit sleep mode.

**Offset Value:** Temperature and humidity offset value can be set.

Click "Save" to save the settings.

Click History button to enter History Menu

The screenshot shows a window titled "History" with a table of recorded data. The table has four columns: "Number", "Record Time", "Temperature(°C)", and "Humidity(%)". Below the table are search filters for "Start time", "End time", and "Device ID", along with buttons for "Export as csv", "Search", and "Exit".

Number	Record Time	Temperature(°C)	Humidity(%)
1	2014-11-13 08:48:25	30.8	64
2	2014-11-13 08:48:49	30.9	65
3	2014-11-13 08:49:13	30.9	61
4	2014-11-13 08:49:37	30.7	56
5	2014-11-13 08:50:01	30.4	52
6	2014-11-13 08:50:25	30.2	49
7	2014-11-13 08:50:49	29.9	46
8	2014-11-13 08:51:13	29.7	44
9	2014-11-13 08:51:37	29.5	43
10	2014-11-13 08:52:01	29.3	42
11	2014-11-13 08:52:25	29.1	42
12	2014-11-13 08:52:49	29.0	41
13	2014-11-13 08:53:13	28.9	41
14	2014-11-13 08:53:37	28.8	41
15	2014-11-13 08:54:01	28.6	41
16	2014-11-13 08:54:25	28.6	41
17	2014-11-13 08:54:49	28.5	41
18	2014-11-13 08:55:13	28.4	41
19	2014-11-13 08:55:37	28.3	41
20	2014-11-13 08:56:01	28.3	41
21	2014-11-13 08:56:25	28.3	41
22	2014-11-13 08:56:49	28.2	41

Start time: 2014-11-10 14:39:11 End time: 2014-11-17 15:39:11 Device ID: 12345678

Buttons: Export as csv, Search, Exit

This screen allows the viewing of the recorded data and also provides a path to export the data to an Excel compatible .CSV file. If you wanted to see all history data in a desired time period, choose the time duration and press Search to reload the history data. If you have multiple data loggers, select the desired device history data from the Device ID pull-down menu. Click Exit button to exit the History Menu.

Click Graph button to enter Graph Menu

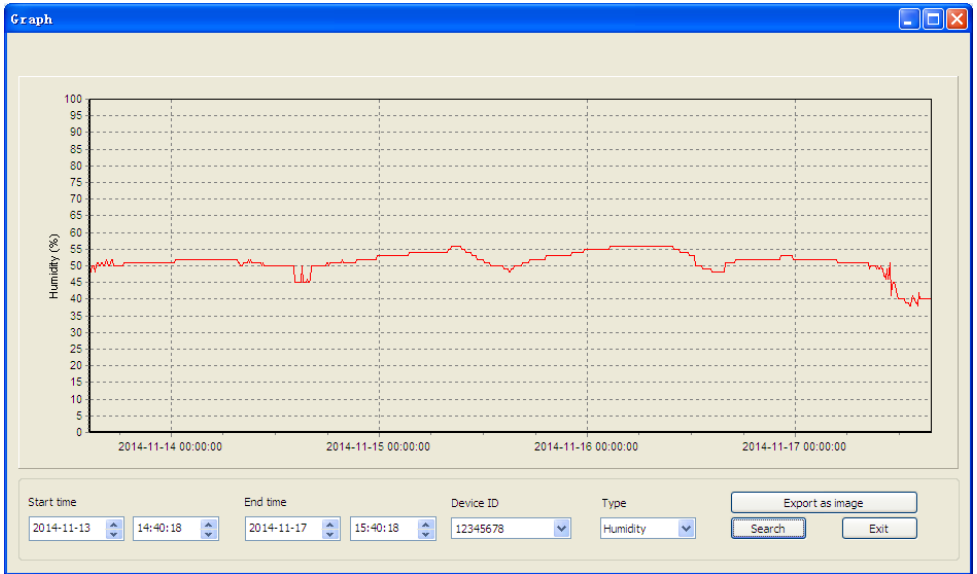

This screen allows the viewing of the history data plotted in graph format and also provides a path to export the data to a .jpeg file. If you want to see more details, just use your mouse to select the area you wanted and the display will be automatically updated in more detailed scale:

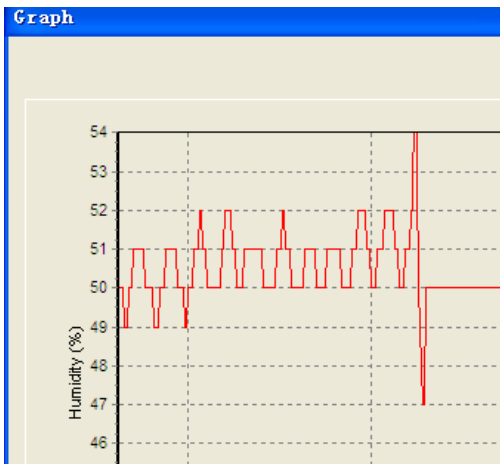

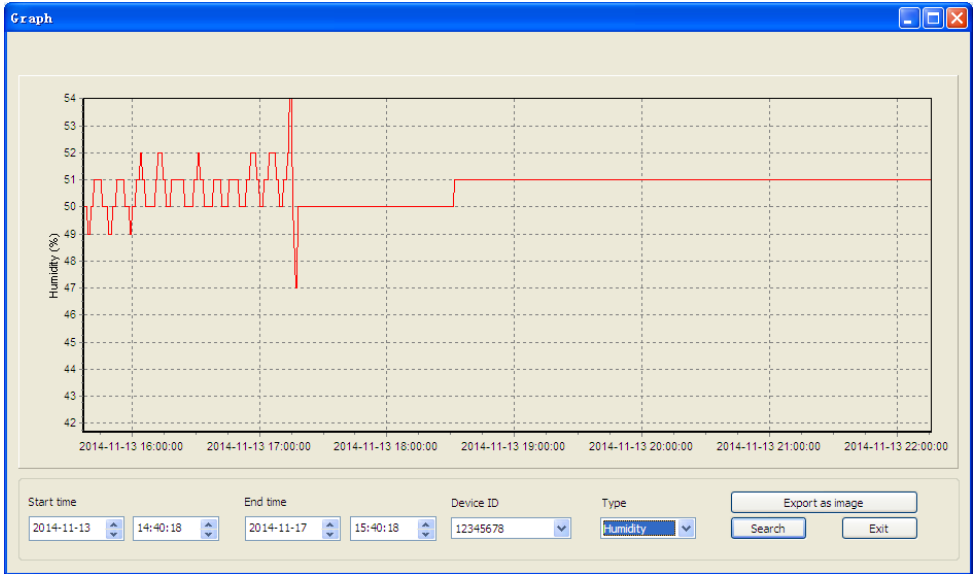

## Management option

Click management button, enters the Management menu

The Management window displays the following controls:

- Delete History**
  - Device ID: 12345678
  - Delete database records
- Current Device ID:** 12345678
  - Delete device records

Click “Delete database records” button to delete the history data on the PC. The user should disconnect the device from the PC to stop the data transfer before they click “Delete database records” button.

Click “Delete device record” button to delete the data record on the device.

### Language option

Click Language button, enters the Language menu

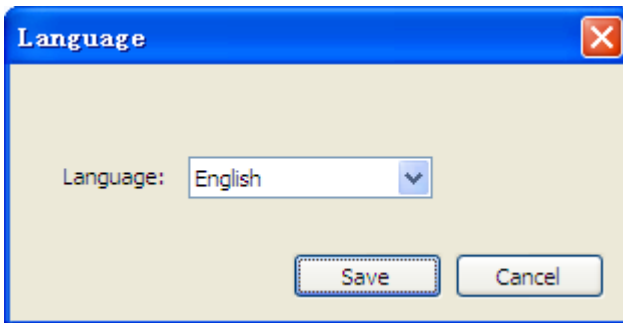

### Help option

About information

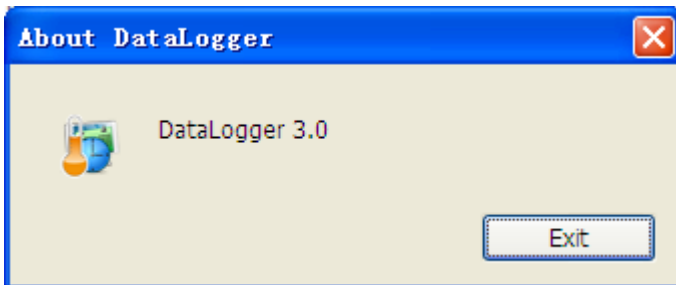

All the settings from the base unit is mirrored into the PC software, so once you have done your setting on the base unit, then you don't need to make any setting changes on the PC software. However you can still easily make any setting changes you wanted from the PC and download the changes into the base station

(the setting change will be refreshed when next full minute arrives on the base station).

**SPECIFICATION:**

Memory : Max 20,736 temperature and relative humidity readings  
Logging Interval : 8 seconds to 4 hours  
Measure Temperature Range: -40 to 60°C  
Temperature accuracy : +/-1.0°C under 0-50°C  
Measures humidity range : 10%-99%RH  
Humidity accuracy : +/-4% under 20%-80%  
Software : Windows XP, windows Vista, windows7, windows 8  
Power : single 3 V lithium battery (included)  
Battery Life : 1 year typical  
(Depends on sample rate, ambient temperature)  
Dimensions : 92x62x18mm