

P8

PodTrak

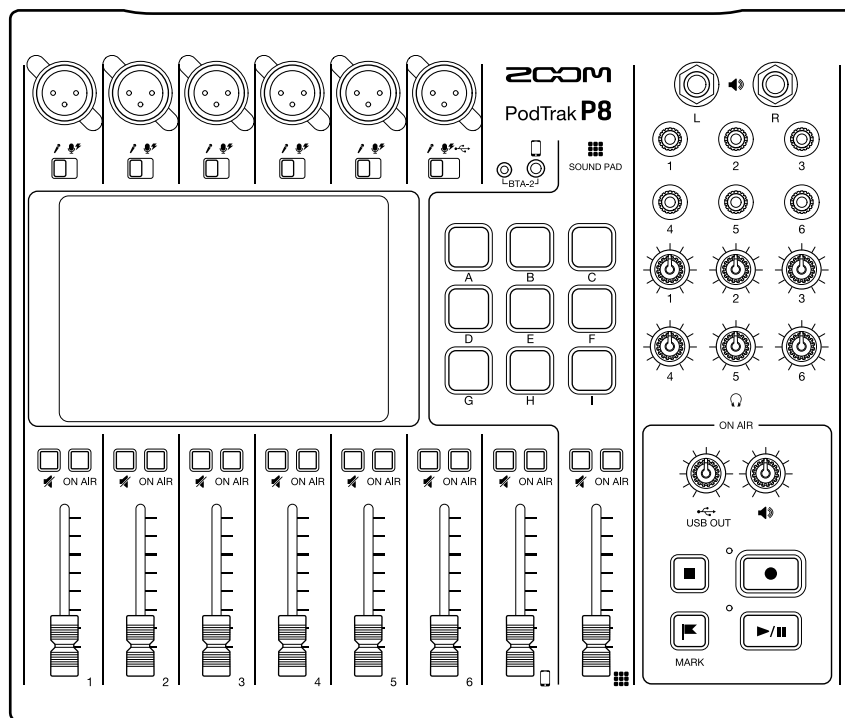

Operation Manual

You must read the Usage and Safety Precautions before use.

© 2021 ZOOM CORPORATION

Copying or reprinting this manual in part or in whole without permission is prohibited.

Product names, registered trademarks and company names in this document are the property of their respective companies. All trademarks and registered trademarks in this document are for identification purposes only and are not intended to infringe on the copyrights of their respective owners.

Proper display is not possible on grayscale devices.

Notes about this Operation Manual

You might need this manual in the future. Always keep it in a place where you can access it easily. The contents of this document and the specifications of the product could be changed without notice.

Items that appear on the touchscreen are shown with a gray background in this operation manual.

Example: Noise Reduction

- Windows® is a trademark or registered trademark of Microsoft® Corporation.
- iPadOS is a trademark or registered trademark of Apple Inc.
- iOS is a trademark or registered trademark of Cisco Systems, Inc. in the USA and other countries and is used under license.
- The SD, SDHC and SDXC logos are trademarks.
- Other product names, registered trademarks and company names in this document are the property of their respective companies.

Note: All trademarks and registered trademarks in this document are for identification purposes only and are not intended to infringe on the copyrights of their respective owners.

Recording from copyrighted sources, including CDs, records, tapes, live performances, video works and broadcasts, without permission of the copyright holder for any purpose other than personal use is prohibited by law. Zoom Corporation will not assume any responsibility related to infringements of copyrights.

Introduction

Thank you very much for purchasing a ZOOM **P8** PodTrak.

The **P8** is a multitrack recorder designed for podcasting. After connecting mics and headphones, high-quality audio recording can be started right away. The **P8** combines all the functions necessary to produce podcasts, including audio enhancement and episode editing in a single device, so we can recommend it to all podcasters from beginners to veterans. We hope you will enjoy recording and producing polished episodes in a variety of locations.

Main features of the P8

Multitrack recording of up to six people at once

The sound qualities and levels of the 6 mic inputs can be adjusted for the voices of the participants. The 6 headphone outputs allow everyone participating to monitor the sound that is being recorded. In addition to a stereo file ready to be used for podcasting, separate files for the audio of each channel can also be recorded and utilized for editing after recording.

Mic sounds can be adjusted optimally

In addition to dynamic mics, the high-quality built-in mic preamps support condenser mics that require phantom power (+48 V). With a single switch, the level of an input can be set optimally according to the mic type. Moreover, in addition to a limiter and low-cut filter, tone adjustment, a compressor that evens out the volume, a de-esser that suppresses sibilance and noise reduction can be applied to the mic sound. All the signal processing is tailored for voices, and each feature is simply turned on/off or adjusted with a single parameter, enabling settings to be made easily even without previous expertise in sound mixing.

Every necessary editing function is built in

The **P8** has every necessary editing function to complete episodes for distribution. These include deleting unnecessary parts of recorded data, optimizing levels automatically, and combining opening and ending files. Intuitive operation using the large 4.3-inch color touchscreen allows anyone to easily complete podcasts without using a computer.

Instant playback of jingles and recorded interviews

The SOUND PAD function includes nine pads with four banks that can be switched even during recording. These pads can be used to play built-in sounds and other audio files in real time. When creating multiple programs, different banks can be prepared for each program. In addition, since the colors that the SOUND PAD buttons light can be set, file assignments can be made easy to see. For example, they could be set blue for files with recorded interviews. Use these to enhance podcasting and live streaming.

Remote recording

If all the podcasters cannot gather in one place or you want to invite guests who are far away, you can use smartphones and computers to enable remote participation in recording. A Mix Minus function prevents echoes from occurring in the audio of remote participants. By connecting a BTA-2 specialized wireless adapter to the **P8**, a smartphone can also be connected to it wirelessly.

Live streaming

The 2-in/2-out USB audio interface functions of the **P8** can be used for live streaming and recording with computers, smartphones and tablets. Since it supports class compliant mode, installation of a dedicated driver is not necessary.

Optional accessory pack

We have prepared an optional Podcast Mic Pack with a dynamic mic (ZDM-1), headphones (ZHP-1) and related accessories, along with software useful for editing on a computer after recording.

Contents

Notes about this Operation Manual	2	Managing files	49
Introduction	3	Deleting files	50
Contents	4	Combining multiple files into one in specific order	52
Podcasting process	5	Editing files	55
P8 overview	7	Opening the File Editing Screen	56
Explanation of terms	7	Changing file names	57
Functions of parts	8	Changing icons	58
Connection examples	11	Cutting unnecessary parts (trimming)	59
Use examples	12	Dividing files	61
Signal flow	13	Adding fade-ins and outs	63
Touchscreen display	15	Adding music and other background sound	66
Preparing for use	17	Optimizing podcast volume (loudness normalization)	69
Inserting SD cards	17	Converting files to MP3 format	71
Providing power	18	Transferring files to a computer, smartphone or tablet	72
Turning the power on	20	Transferring files to a computer, smartphone or tablet	72
Making initial settings	22	P8 folder and file structure	73
Connecting	24	Modifying the date and time	74
Connecting mics	24	Changing the touchscreen display language	75
Connecting headphones	25	Setting the battery type	76
Connecting smartphones	26	Adjusting the brightness of the touchscreen	77
Connecting a BTA-2 (dedicated wireless adapter)	27	Using noise reduction	78
Connecting a computer, smartphone or tablet by USB	28	Setting recording file types	79
Connecting powered speakers and other output equipment	31	Testing SD cards	80
Recording	32	Formatting SD cards	83
Adjusting input gain and sound quality	32	Using SD cards to back up and load settings	84
Balancing the mix of channel levels	35	Backing up	84
Recording	36	Loading backup settings	85
Playing recordings	37	Setting the automatic power off function	87
Playing recordings on the Home Screen	37	Restoring factory default settings	88
Selecting files and playing them	38	Updating the firmware	89
Using marks	40	Troubleshooting	90
Adding marks	40	General	90
Deleting marks	41	Audio interface	91
Using SOUND PAD functions	42	Specifications	92
Playing SOUND PAD buttons	42	Mixer block diagram	93
Assigning audio files to SOUND PAD buttons	43		
Adjusting the levels of each SOUND PAD	46		
Setting playback modes for each SOUND PAD	47		
Changing bank names	48		

Podcasting process

1. Prepare and confirm connections

● Preparations

Install an SD card in the **P8**, provide it power, and set the date and time.

● Connecting and checking

Connect microphones and headphones.

- By using a single mic for each person, levels can be adjusted to suit each voice, enabling clear recording of all voices.
- Adjust the distance between the participants and their mics so that they can be recorded at stable levels. On the **P8**, the input gain can be set suitably for a connected mic by setting its INPUT SELECT switch.
- Using the **P8**, tones of voices can be adjusted and compressors and de-essers can be applied.
- Mute input channels that are not being used to prevent noise from being picked up.
- Headphones are necessary to not only confirm the inputs from the mics, but also to hear SOUND PAD playback and the voices of guests participating remotely.

If a guest in a distant location is participating remotely in recording, connect the **P8** to a computer, smartphone or tablet.

- The smartphone connector is designed to prevent echo when used. When using the USB port, turn on USB Mix Minus to prevent echo.

Confirm the levels and other settings of the SOUND PAD buttons, which can be used for one-touch playback of background music, jingles and other sounds during recording.

● Countermeasures for environmental noise in recording locations

- Attaching windscreens to mics can reduce noise caused by wind blowing. Adjust the directions of mics so that they do not point toward other sources of environmental noise.
- Touching mics and power cables during recording could result in handling noise that sounds like crackling. Use mic stands and put cables in order beforehand. Placing mic cables and power cables too close together can result in noise being picked up.
- Enabling the Low Cut function on the **P8** mic input settings screens can reduce the amount of vibration, wind and other noise picked up by mics.
- When multiple mics are being used to record sound, turning on noise reduction on the **P8** ON AIR settings screen can suppress background noise to a constant level by automatically reducing the levels of the mic inputs not being used by people.

2. Record

● Recording theme

To enable recording conversations at a good pace, confirm the discussion topics with the other participants and prepare reference materials and other resources so that they are at hand.

● Speaking tips

Try to speak clearly while avoiding making sibilant (hissing s) and plosive (p and d) sounds too loud.

● SOUND PAD buttons

Use these to add excitement to programs with jingles and effects.

3. Publish

● Publishing

The **P8** USB file transfer screen can be used to connect to a computer, smartphone or tablet and transfer recorded files. Upload them to the podcasting service* or server you are using.

*Service that provides servers for saving podcast files

● Editing before release

The **P8** can be used to edit recorded stereo files for podcasting in the following ways.

- Unnecessary parts can be cut, and fade ins/outs can be added.
- Background music can be added.
- The loudness normalization function can even out the volume ideally for podcasting.
- Openings and endings that have been prepared in advance can be attached to the beginnings and ends.
- Files can be converted to MP3s.

Moreover, the individual files recorded for each channel on the **P8** can be used for detailed editing in a DAW and to make adjustments for the voices of each participant.

P8 overview

Explanation of terms

Audio interface

The **P8** enables sounds from mics and instruments, for example, to be input to a computer, smartphone or tablet. It can also output sounds from that device to speakers and headphones.

USB audio return

When the **P8** is connected as an audio interface, this is the signal output from the computer, smartphone or tablet. Background music can be played from the connected device.

SOUND PAD buttons

Audio files can be assigned to these. Press one to play the assigned file. This is convenient for playing interviews that have been recorded in advance, opening and ending music and jingles.

The 9 SOUND PAD buttons can have audio files assigned in 4 banks, for a total of 36 files.

USB Mix Minus

When using the **P8** as an audio interface, signals input by USB can be set to not be output back to USB. This can prevent feedback to the person at the other end when recording while calling through a computer, smartphone or tablet.

ON AIR button

When ON AIR buttons are turned off, input sounds are not output to the USB port (streaming audio) or SPEAKER OUT jacks, nor are they recorded to the podcast stereo file. This function is convenient, for example, when participants are discussing the next topic among themselves while music is playing.

Podcasting

This is one way to share audio files publicly on the Internet. Podcasters make content and distribute it via the Internet so people can listen easily on smartphones, computers and other devices.

Dynamic mic

This type of mic does not require phantom power and is strong and durable.

Condenser mic

This type of mic usually has high sensitivity and can capture audio with high quality. Phantom power supply is necessary for use.

Functions of parts

■ Top

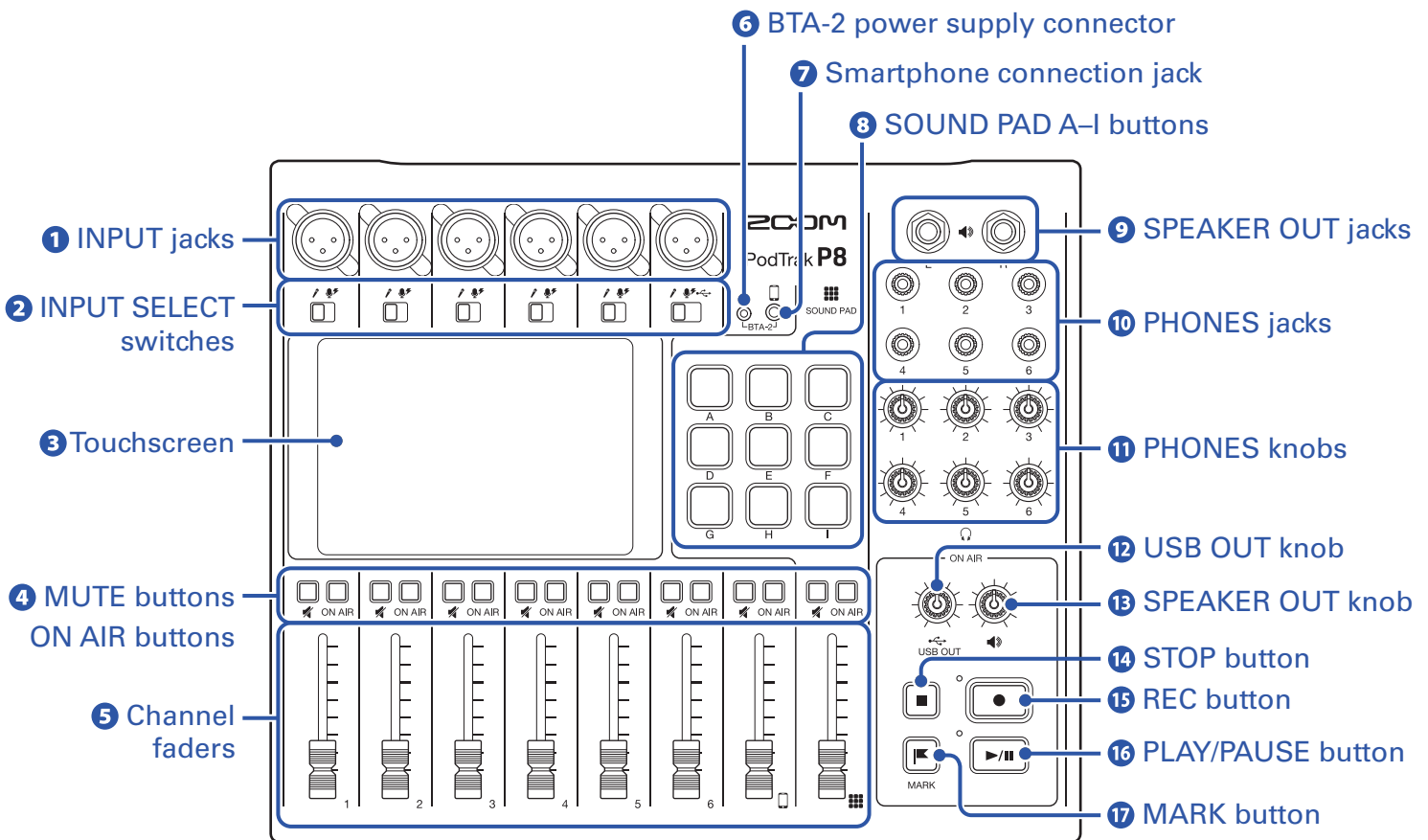



1 INPUT jacks

These input jacks have built-in mic preamps.

2 INPUT SELECT switches

Set these according to the connected equipment.

-  Dynamic mic
-  Condenser mic (supplies +48V phantom power)
-  Computer, smartphone or tablet

3 Touchscreen

This shows the status of the **P8**, and can be operated by touch to make various settings and edit files.

4 MUTE buttons

Use to mute (lit) and unmute (unlit) signals.

ON AIR buttons

When lit, channel signals are recorded in the podcast stereo file and sent to the USB port, SPEAKER OUT jacks, PHONES jacks and smartphone connection jack.

When unlit, channel signals are only sent to the PHONES jacks and smartphone connection jack.

5 Channel faders

These adjust channel signal levels in ranges from $-\infty$ to +10 dB.

6 BTA-2 power supply connector

Use this power supply connector when connecting a BTA-2 wireless adapter.

7 Smartphone connection jack

Connect a smartphone here.

8 SOUND PAD A–I buttons

Use to play the sounds assigned to them.

9 SPEAKER OUT jacks

These output a stereo mix of the signals from all the channels. Connect them to a power amplifier, a PA system or speakers with built-in amplifiers, for example.

10 PHONES jacks

These output a stereo mix of the signals from all the channels. Connect headphones to these.

11 PHONES knobs

Use to adjust the volumes of the signals output from the PHONES jacks.

12 USB OUT knob

Use to adjust the volume of the signal output from the USB port.

13 SPEAKER OUT knob

Use to adjust the volume of the signals output from the SPEAKER OUT jacks.

14 STOP button

Use to stop recording/playback.

15 REC button

Use to start/stop recording.

16 PLAY/PAUSE button

Use to play/pause recorded files.

17 MARK button

Press to add marks to recording files during recording/playback. These provide editing guides.

■ Back

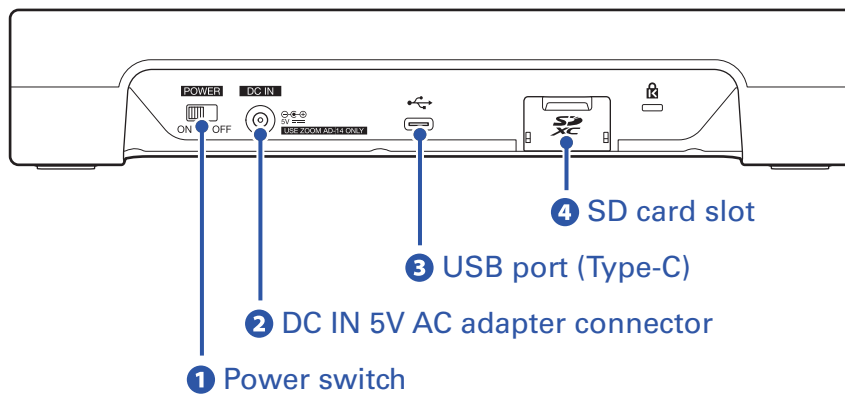

1 Power switch

Use to turn the power on and off.

2 DC IN 5V AC adapter connector

Connect the included AC adapter here.

3 USB port (Type-C)

This USB port is for connecting with a computer, smartphone or tablet.

4 SD card slot

Cards that conform to SDHC and SDXC specifications are supported.

Format the SD card with the **P8** before use. (→ [“Formatting SD cards” on page 83](#))

Connection examples

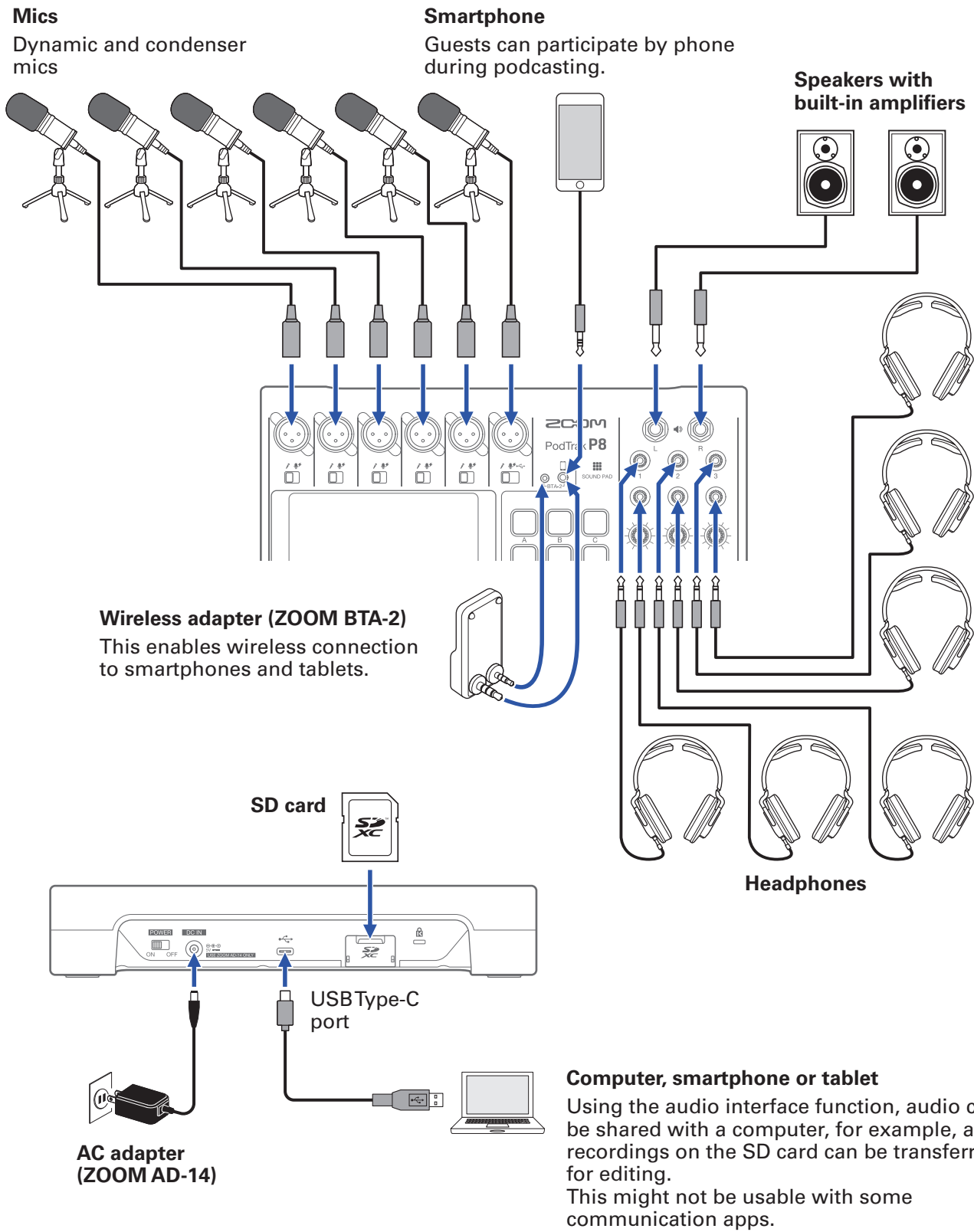

HINT

We have prepared an optional Podcast Mic Pack that is ideal for podcasting. The set includes a ZDM-1 dynamic mic and ZHP-1 headphones, enabling you to start podcasting right away.

Use examples

Podcasting with a guest participating by phone

By connecting a computer, smartphone or tablet to the **P8**, a guest in a remote location can participate in a podcast by phone.



Live streaming

By connecting a **P8** to a computer, smartphone or tablet, you can use it to stream audio in real time.



Signal flow

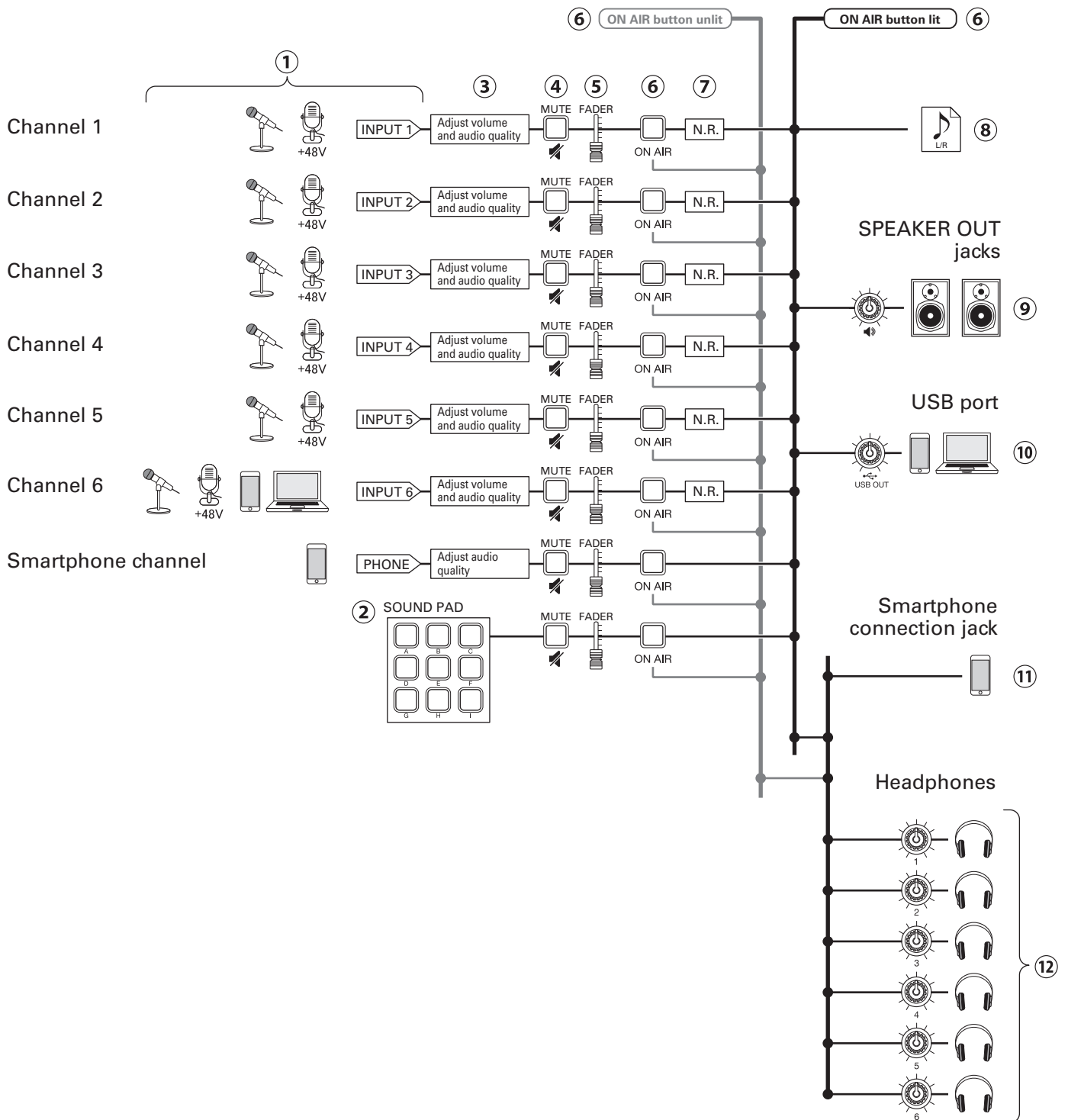

- ① Input sound. Channels 1–5 can be used to input sound from mics. Channel 6 can be used to input sound from a mic or the USB audio return. The smartphone channel can be used to input sound from a smartphone.
- ② Play SOUND PAD sounds.
- ③ Make settings for inputs on each channel. Input gain can be adjusted, and a function that cuts unwanted low frequencies and a limiter can be turned on or off (mic inputs only). In addition, the sound quality of all inputs can be adjusted.
- ④ Mute/unmute channels. Inputs not being used can be muted.

- ⑤ Use the faders to adjust the levels of each channel in the mix.
- ⑥ Turn ON AIR on or off. When the ON AIR button is off (unlit), sound will not be output to the podcast stereo file, SPEAKER OUT jacks or USB port.
- ⑦ Turn noise reduction on or off. When multiple mics are being used to record sound, turning this on suppresses background noise to a constant level by automatically reducing the levels of the mic inputs not being used by people.
- ⑧ A recording file is made for podcasting. This combines all channels and the SOUND PAD sounds into a stereo file.
- ⑨ Output the mixed sound of all channels or the playback of audio files on an SD card to speakers with built-in amplification, for example.
- ⑩ A mix of all channels is output to the computer, smartphone or tablet connected by USB. When the USB Mix Minus setting (→ [page 30](#)) is on, the sound input through channel 6 (the USB audio return) is not included.
- ⑪ A mix of all channels is output to the connected smartphone. The sound from the connected smartphone itself, however, is not sent back to it.
- ⑫ Monitor the sound of the recording for podcasting through headphones. Channels with ON AIR off will also be output. The volume can be adjusted separately for each pair of headphones.

HINT

Individual files can also be recorded for INPUT 1–6, PHONE and SOUND PAD channels. (→ [“Setting recording file types” on page 79](#))

Touchscreen display

Home Screen overview

This screen appears on the touchscreen when the **P8** power is turned on.

This shows the state of the **P8**, including recording conditions and input levels. In addition, various functions can easily be accessed by tapping buttons on it.

Status icon

This shows the recorder status.

- Recording
- Recording paused
- Mark added
- Recording stopped

Counter

This shows either the current elapsed recording time or the remaining available recording time.

Date and time

Use to make settings related to the date/time and display language.

SD card button

Use to make settings related to the SD card.

Library button

This shows files on the SD card, and enables file management and editing.

Level meters

These show the output levels of each channel and the stereo mix for podcasting.



Power button

Use to make settings related to the power.

- Powered by AC adapter:
- Powered by USB:
- Powered by batteries:

Track buttons

Use these to make input settings for each channel, including mic settings and audio quality adjustments. The icons depend on the selected input type.

ON AIR settings button

Use to turn Noise Reduction on/off and make recording track settings.

Touchscreen operation overview

Using various screens

Operate by tapping and sliding.

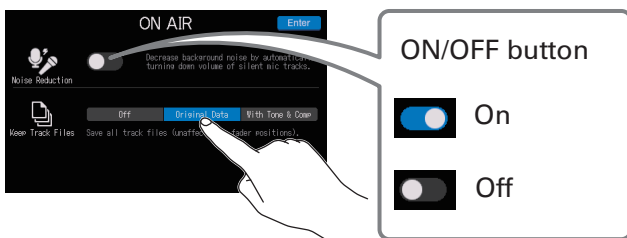

Tap to select or turn on/off

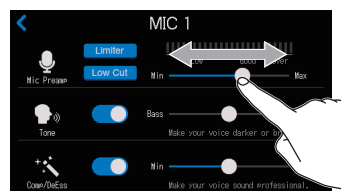

Slide to adjust (move left/right while touching)

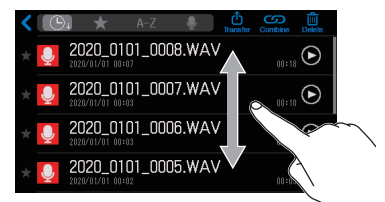

Slide to scroll items (move up/down while touching)

■ Returning to the previous screen or the Home Screen

Tap  at the top left of the screen.

To return to the Home Screen, tap  repeatedly until it appears.

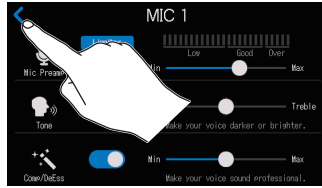

Character input screen

The character input screen appears on the touchscreen when changing the names of files and SOUND PAD banks.

Tap the keyboard and input characters.

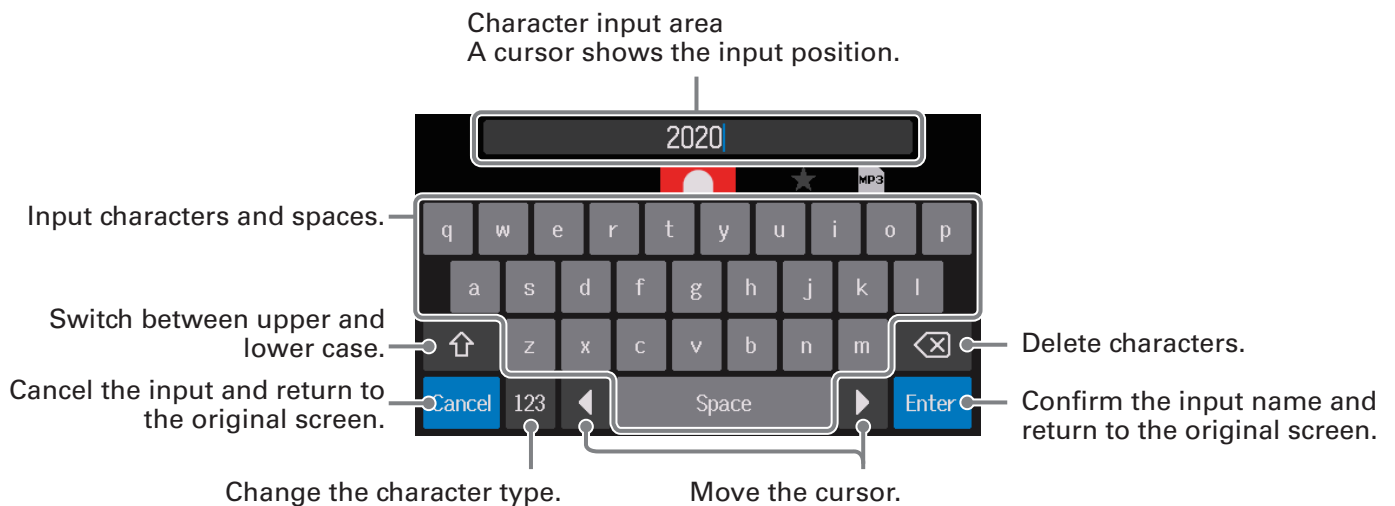

NOTE

The characters and symbols that can be used are as follows.

! # \$ ' () + , - ; = @ [] ^ _ ` { } ~ (space) A-Z, a-z, 0-9

Preparing for use

Inserting SD cards

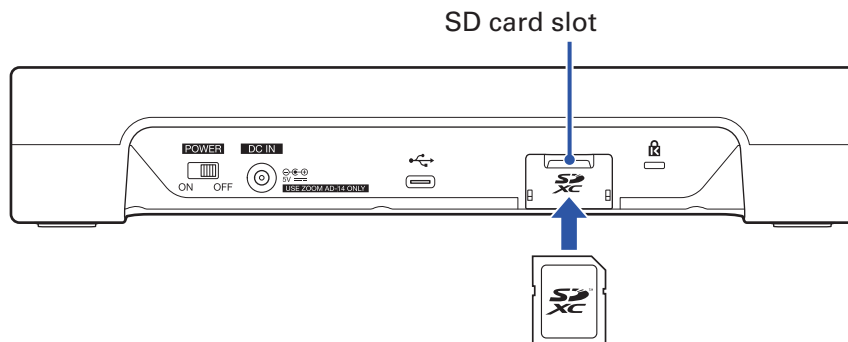

1. With the power off, open the SD card slot cover, and insert an SD card all the way into the slot. To remove an SD card, push it further into the slot and then pull it out.

NOTE

- Cards that conform to SDHC and SDXC specifications are supported.
- Disable write-protection on the SD card before inserting it.
- Inserting or removing an SD card while the power is on could result in data loss.
- When inserting an SD card, be sure to insert the correct end with the top side up as shown.
- If an SD card is not loaded, recording and playback are not possible.
- Before using SD cards that have just been purchased or that have been formatted on a computer, they must be formatted by the **P8** (→ [“Formatting SD cards” on page 83](#)).

Providing power

The **P8** can be powered by an AC adapter, USB bus power or batteries.

The order of power supply priority is AC adapter first, USB bus power next, and batteries last.

Using an AC adapter

Connect the dedicated AC adapter (AD-14) cable to the DC IN 5V AC adapter connector and the adapter to an outlet.

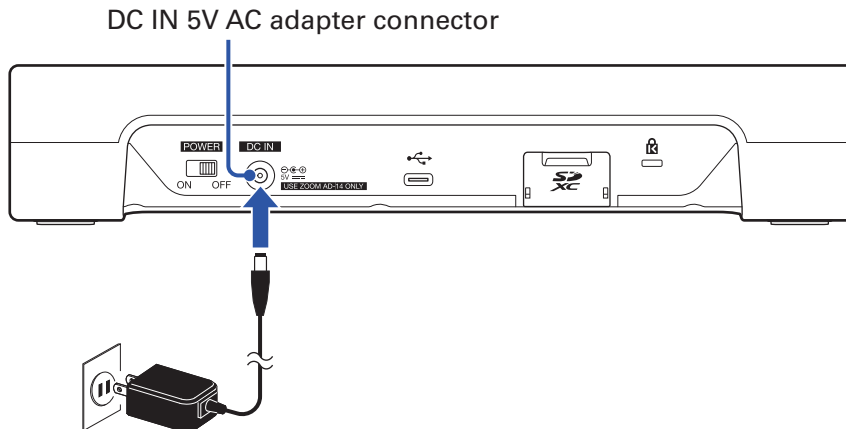

Installing batteries

To run the **P8** on battery power, open the battery compartment cover on the bottom and install 4 AA batteries.

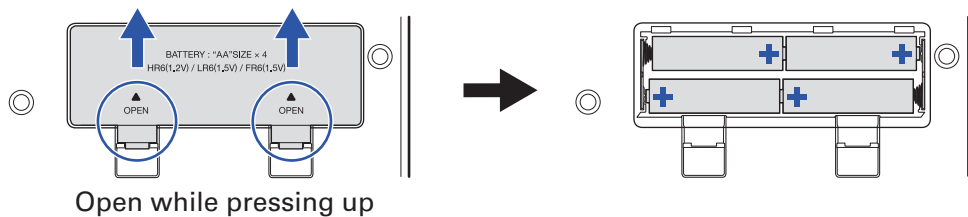

NOTE

- Use only one type of battery (alkaline, NiMH or lithium) at a time.
- Set the type of battery used correctly so that the amount of remaining battery charge can be shown accurately. (→ [“Setting the battery type” on page 76](#))
- The battery charge can be checked on the Home Screen (→ [page 15](#)).

Other power sources

By connecting this USB port (Type-C) to a computer, the **P8** can be operated on USB bus power. Operation using a portable battery is also possible.

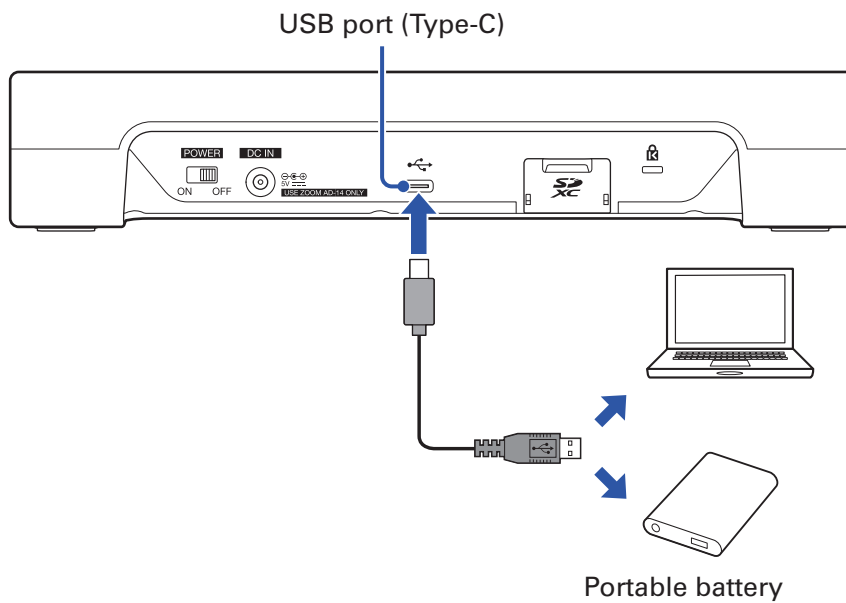

NOTE

When Tablet Mode (→ [page 29](#)) is on, operation using USB bus power is not possible.

Turning the power on

1. Confirm that the output devices connected to the **P8** are turned off.

2. Set all  and faders to their minimum values.

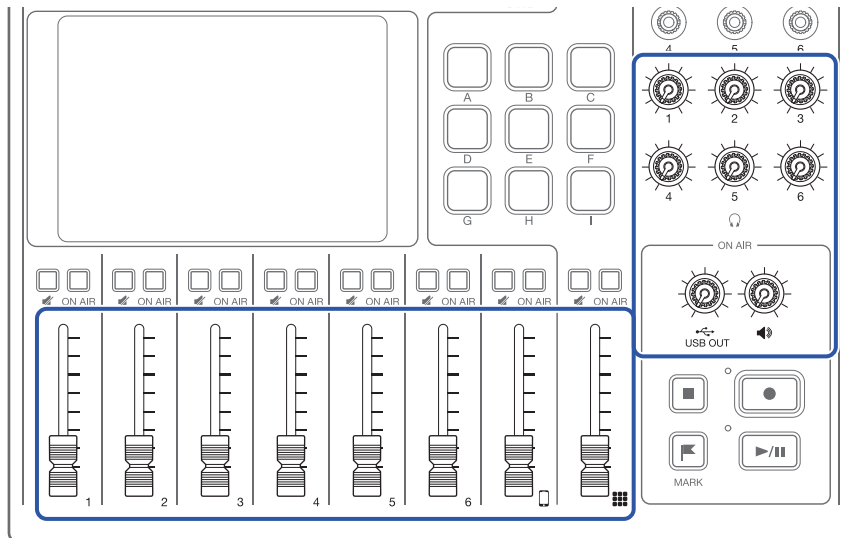

3. Set  to ON.

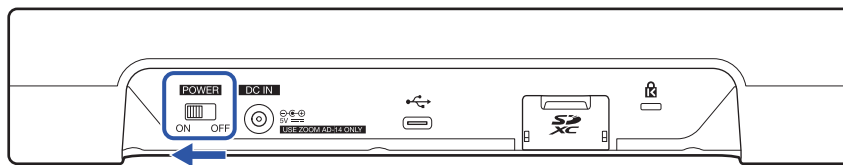

This turns the power on and opens the Home Screen on the touchscreen.

The first time the power is turned on after purchase and after the **P8** has been restored to its factory default state, make initial settings. (→ [“Making initial settings” on page 22](#))

4. Turn on the output devices connected to the **P8**.

NOTE

When running on power from the AC adapter, the **P8** will automatically turn off if it is unused for 10 hours. To keep the power on at all times, disable the automatic power saving function. (→ [“Setting the automatic power off function” on page 87](#))

Turning the power off

1. Minimize the volume of output devices connected to the **P8**.

2. Turn off the output devices connected to the **P8**.

3. Set  to OFF.

After “Goodbye SeeYou!” appears on the touchscreen, the power turns off.

NOTE

When the power is turned off, the current settings are saved on the **P8**.

Making initial settings

Setting the date/time and language (first time starting up)

The first time the power is turned on after purchase, a screen where the date/time and language can be set opens on the touchscreen.

The date and time are stored in recorded files, and the date and time recording started are used in the file name. Having the correct date and time set is helpful when looking for files, for example, by allowing content to be identified by names.

The language shown on the touchscreen can also be selected.

1. Tap the language to be shown on the touchscreen.

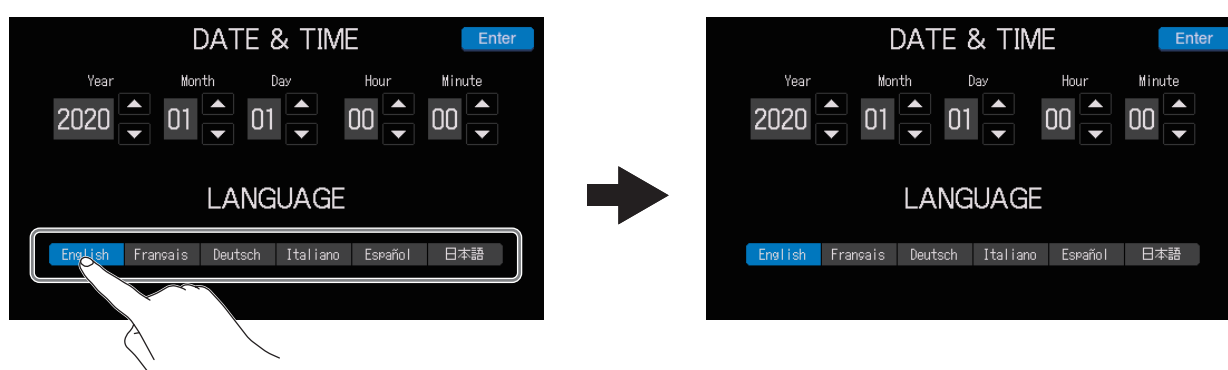

The touchscreen display will change to the selected language.

2. Tap ▲ and ▼ to set the Year, Month, Day, Hour, and Minute.

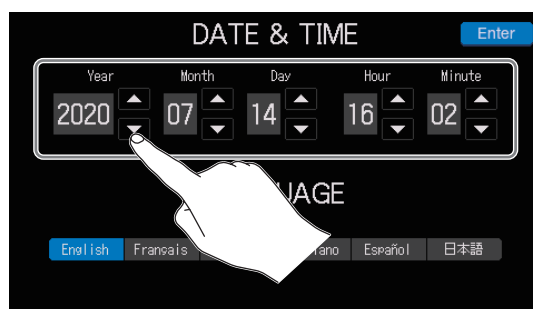

3. After setting the date and time, tap Enter.

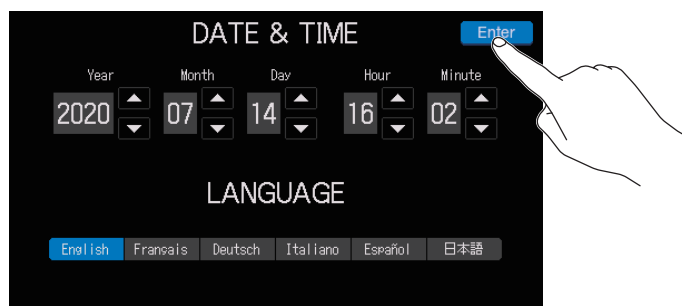

This confirms the set date and time and opens the ON AIR settings screen.

HINT

The date/time and language settings can be changed later by tapping the Date and Time display on the Home Screen. (→ [“Modifying the date and time” on page 74](#))

Setting noise reduction and recording file types (first time starting up)

Next, turn Noise Reduction on or off and set the recording file type.

When multiple mics are being used to record sound, the noise reduction function of the **P8** suppresses background noise to a constant level by automatically reducing the levels of the mic inputs not being used by people.

1. Tap the ON/OFF button to turn **Noise Reduction** on or off.

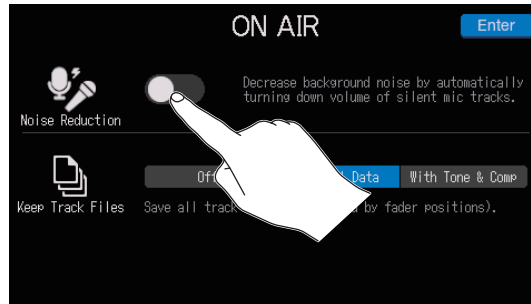

2. Tap the recording file type setting.

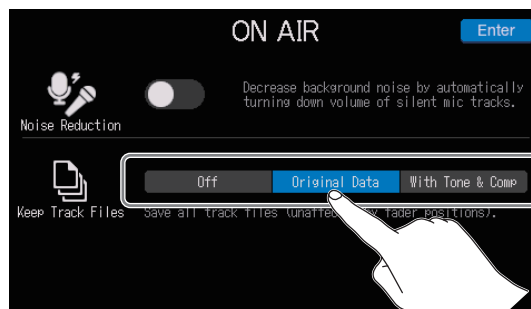

Setting	Explanation
Off	Only record stereo files for podcasting.
Original Data	In addition to stereo files for podcasting, individual files are also recorded for each channel. The individual files for each channel are recorded before being affected by the fader, Tone, Comp/DeEss and other adjustments.
With Tone & Comp	In addition to stereo files for podcasting, individual files are also recorded for each channel. The individual files for each channel are recorded before faders, but after being affected by the Tone, Comp/DeEss and other adjustments.

3. When done making settings, tap **Enter**.



This completes initial settings and opens the Home Screen on the touchscreen.

HINT

The noise reduction and recording file settings can be changed later by tapping **ON AIR** on the Home Screen. (→ [“Using noise reduction”](#) on page 78, [“Setting recording file types”](#) on page 79)

Connecting

Connecting mics

Connect mics to capture sound. Up to 6 mics can be connected.

Dynamic and condenser mics
Use mic cables (with XLR connectors) to connect them to INPUT jacks 1-6.

2: HOT 1: GND 3: COLD

INPUT SELECT switches 1-6
Set to when using a dynamic mic or to when using a condenser mic. Gain will be set suitably for the selection.

MUTE buttons 1-6
Confirm that these are not lit.

ON AIR buttons 1-6
Confirm that they are lit.

Track buttons 1-6
Tap to adjust mic gain and audio quality (→ [page 32](#)).

Track buttons appear as follows according to their INPUT SELECT switch settings.

setting:

setting:

setting:

NOTE

When an INPUT SELECT switch is set to , +48V phantom power is supplied to that INPUT jack. When connecting to a device that is not compatible with phantom power, do not set the INPUT SELECT switch to . Doing so could damage the device.

Connecting headphones

Connect headphones to check the sound. The PHONES 1-6 jacks output the same sound. Up to 6 pairs of headphones can be connected.

Headphones

Connect to PHONES jacks 1-6.

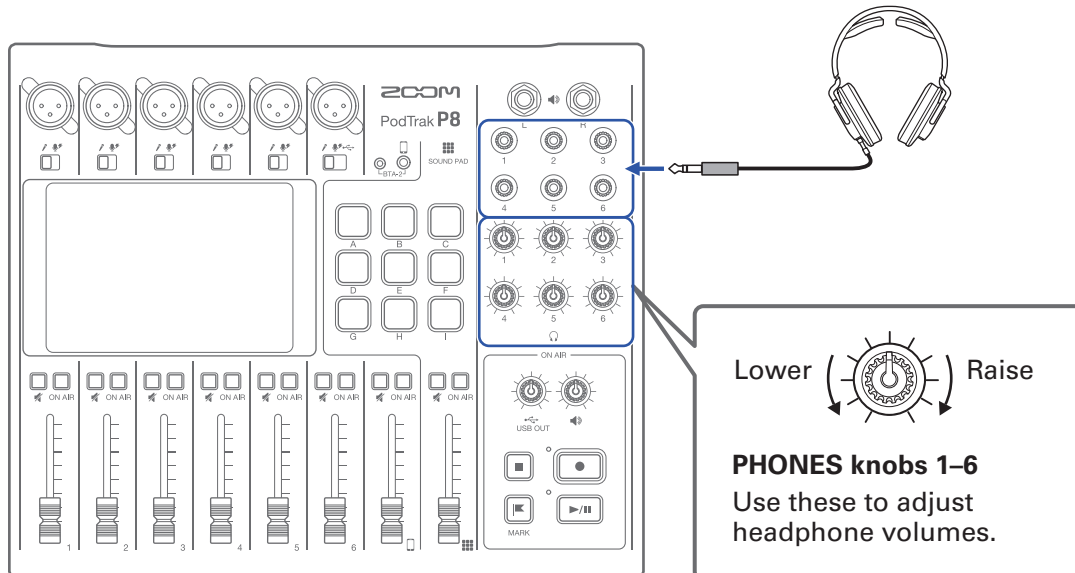

Connecting smartphones

The following operations are possible when a smartphone is connected to the smartphone connection jack.

- When podcasting, the voice of a guest participating by phone can be input on the smartphone channel. By using a 4-contact mini-plug cable, a signal can be input from a smartphone and a mono signal can be sent back to it simultaneously. Since this output signal does not include the sound from the smartphone channel, guests participating by phone will not have an echo.
- Music played back on a smartphone can be input on the smartphone channel.

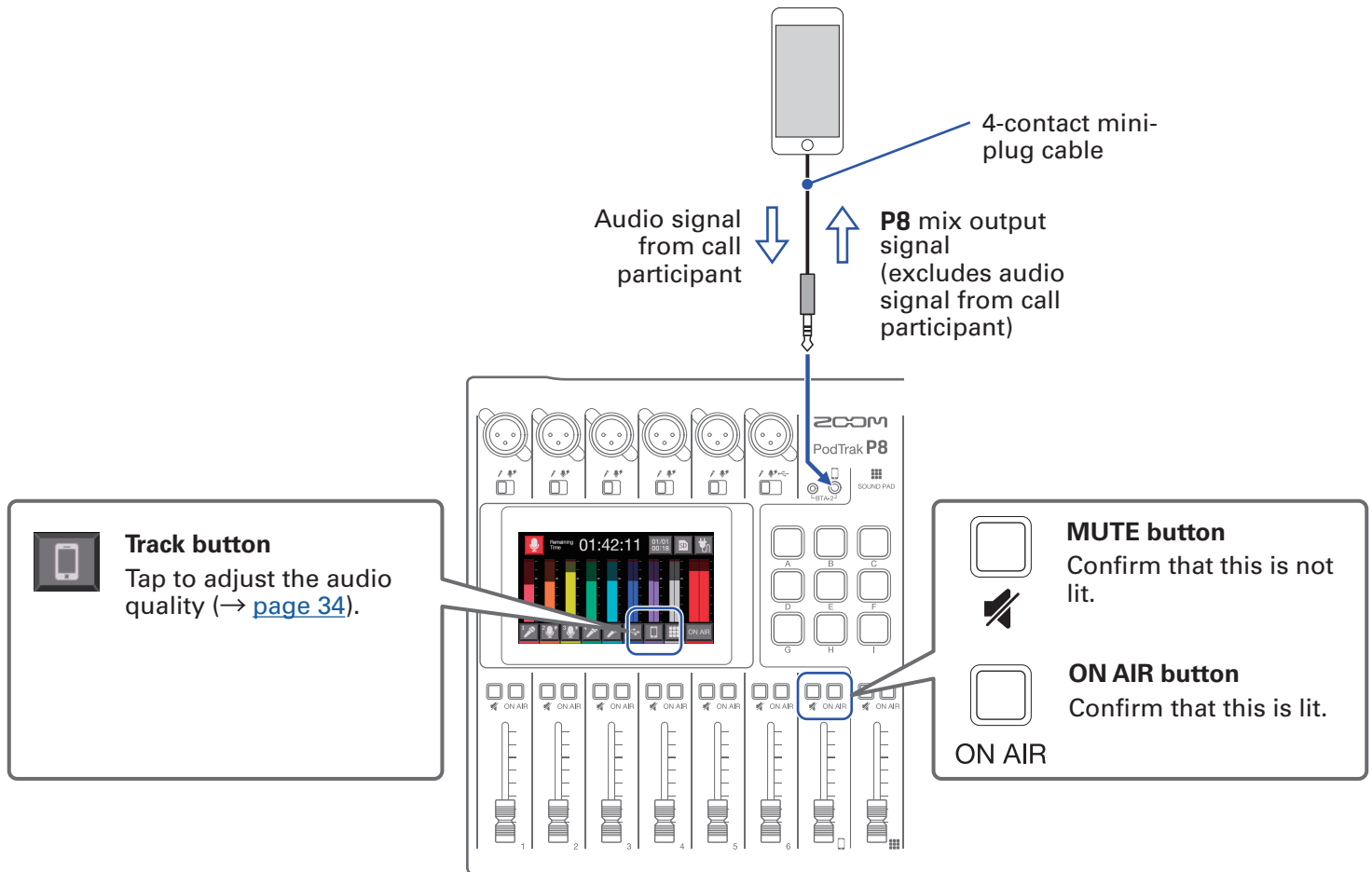

4-contact mini-plug

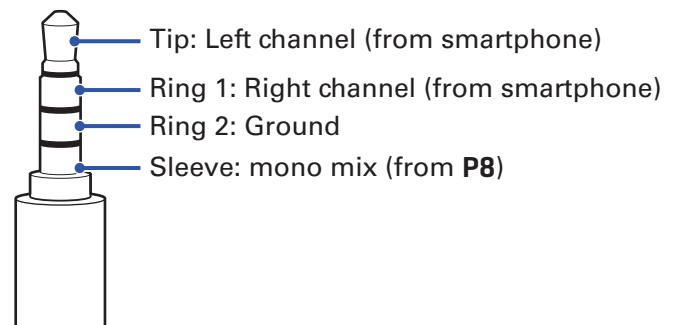

Connecting a BTA-2 (dedicated wireless adapter)

By connecting a BTA-2, audio can be input through the smartphone connection jack via Bluetooth.

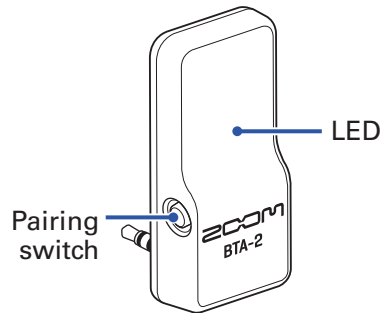

Connecting

Pairing must be conducted the first time connecting.

1. While the **P8** power is off, connect the BTA-2 to the smartphone connection jack and the BTA-2 power supply connector.

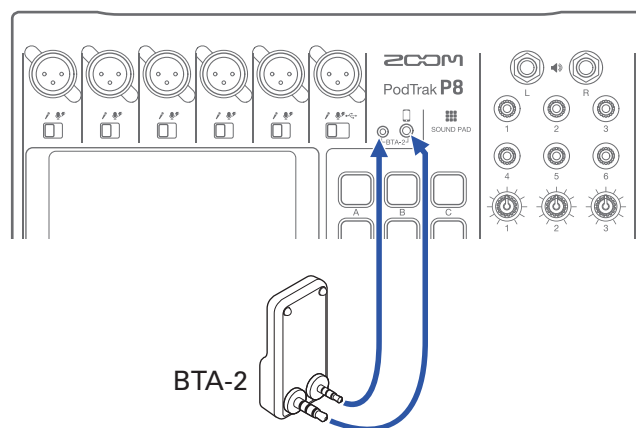

2. Turn the **P8** power on (→ [“Turning the power on” on page 20](#)).
The LED lights white when power is being supplied to the BTA-2.
If a smartphone has already been paired, it will automatically be connected at this time.
3. Press and hold the pairing switch until the BTA-2 LED blinks white.
This puts the BTA-2 into connection standby.
4. Conduct connection procedures on the smartphone.
The LED will light blue when connection completes.

Disconnecting

1. Conduct disconnection procedures on the smartphone.
This disconnects it.
2. The **P8** power should be off when disconnecting a BTA-2.

Connecting a computer, smartphone or tablet by USB

The following operations are possible when a computer, smartphone or tablet is connected to the USB port (Type-C).

Audio interface function

- Background music playing or communication audio on a computer, smartphone or tablet can be input on channel 6. (→ [“Inputting USB audio return on channel 6” on page 30](#))
- Sound input through the **P8** and sounds played with SOUND PAD buttons can be sent to a computer, smartphone or tablet and streamed live as is. (→ [“Audio interface function overview” on page 29](#))

USB file transfer function

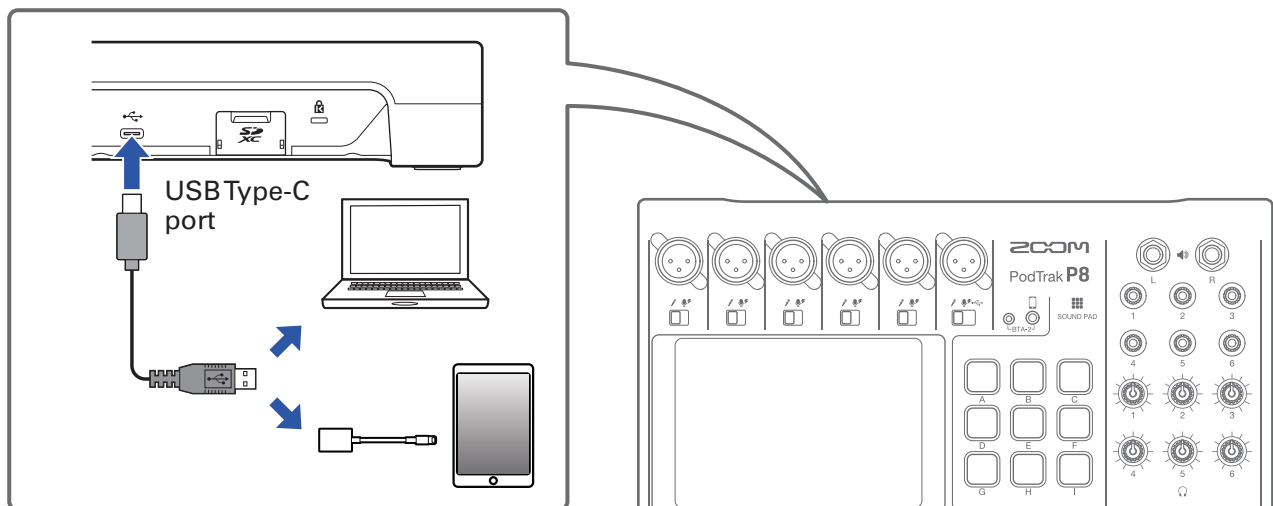

- Recording files on SD cards can be transferred to computers, smartphones and tablets. These files can then be uploaded to hosting services and servers that you are using. (→ [“Transferring files to a computer, smartphone or tablet” on page 72](#))



NOTE

Use a Lightning to USB Camera Adapter (or Lightning to USB 3 Camera Adapter) to connect to an iOS/iPadOS device with a lightning connector.

Preparing to connect a smartphone or tablet

1. Connect an AC adapter or install batteries before turning the **P8** on (→ [“Turning the power on”](#) on page 20).
2. Tap the  /  power button on the Home Screen.
3. Tap the **Tablet Mode ON/OFF** button to turn it on.

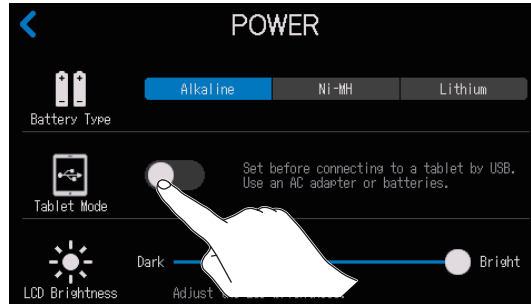

4. Connecting a smartphone or tablet

NOTE

- When **Tablet Mode** is on, operation using USB bus power is not possible.
- If already operating on USB bus power and batteries have not been installed, **Tablet Mode** cannot be turned on/off.
- **Tablet Mode** will be off the next time that the **P8** starts up.

HINT

The **Tablet Mode** function is intended to prevent power draw from smartphones and tablets that are not capable of providing USB bus power.

Audio interface function overview

The **P8** can be used as a 2-in/2-out audio interface.

The following operations are possible by using the audio interface functions.

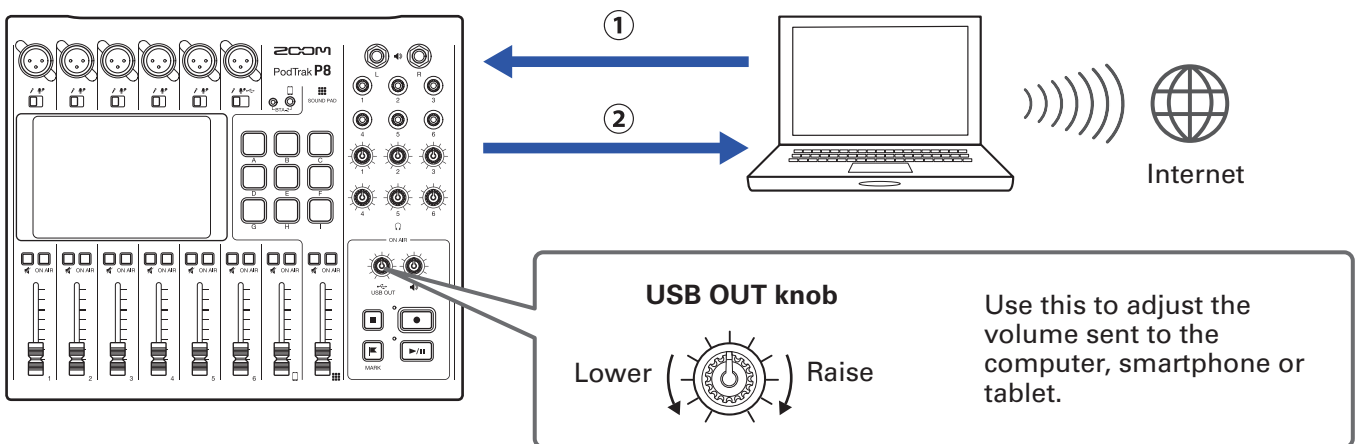

- ① Music playing or call audio on a computer, smartphone or tablet can be input on channel 6 of the **P8**.
- ② Audio input to the **P8** and audio played using **SOUND PAD** buttons can be sent to a computer or other device connected to the Internet and streamed in real time.

Inputting USB audio return on channel 6

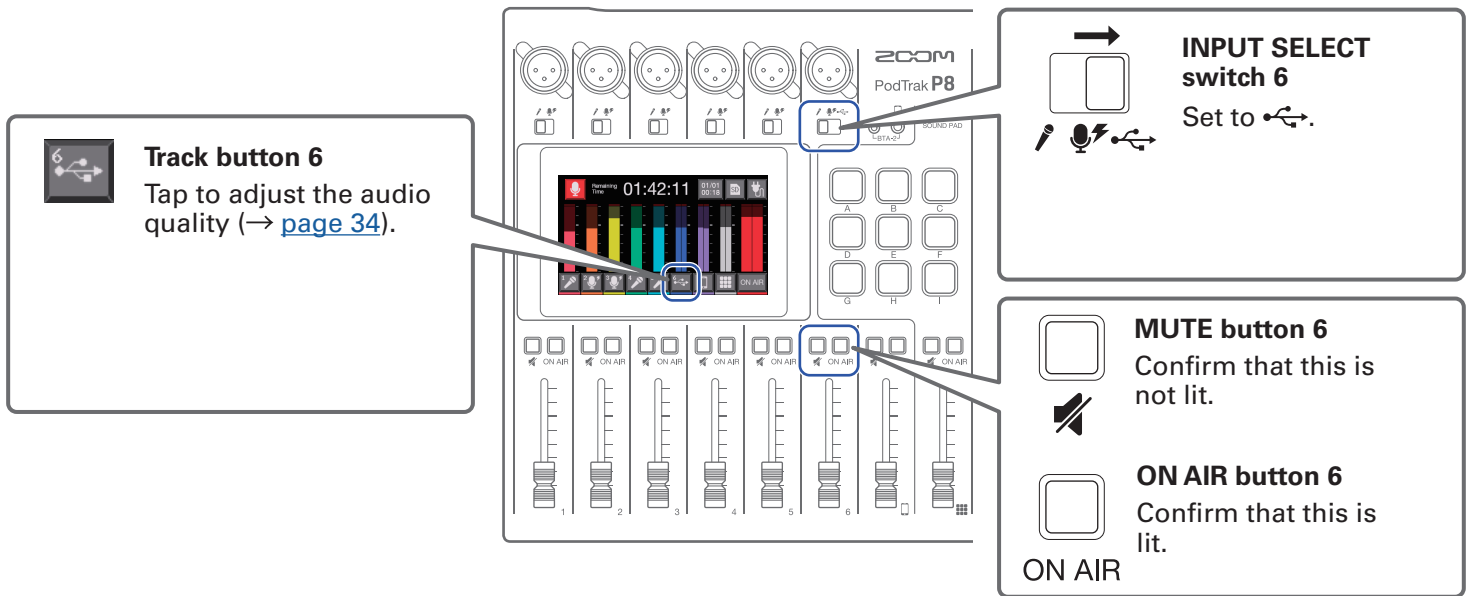

Select the **P8** as the input and output device on the connected computer or other device.

NOTE

“ZOOM P8 Audio” will appear on the computer.

Setting USB Mix Minus

When using the **P8** as an audio interface, this can prevent feedback to a person participating in a call through the connected device.

1. Tap on the Home Screen.
2. Tap the ON/OFF button to change the **USB Mix Minus** setting.

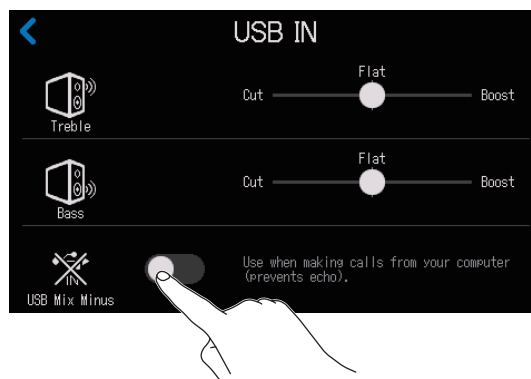

Setting	Explanation
OFF	Sound from USB input is also output by USB.
ON	Sound from USB input is not output by USB.

Connecting powered speakers and other output equipment

Audio from the **P8** can be output to connected powered speakers or other output equipment. This is useful when, for example, listening to recorded files in a group and editing such files.

Powered speakers, etc.



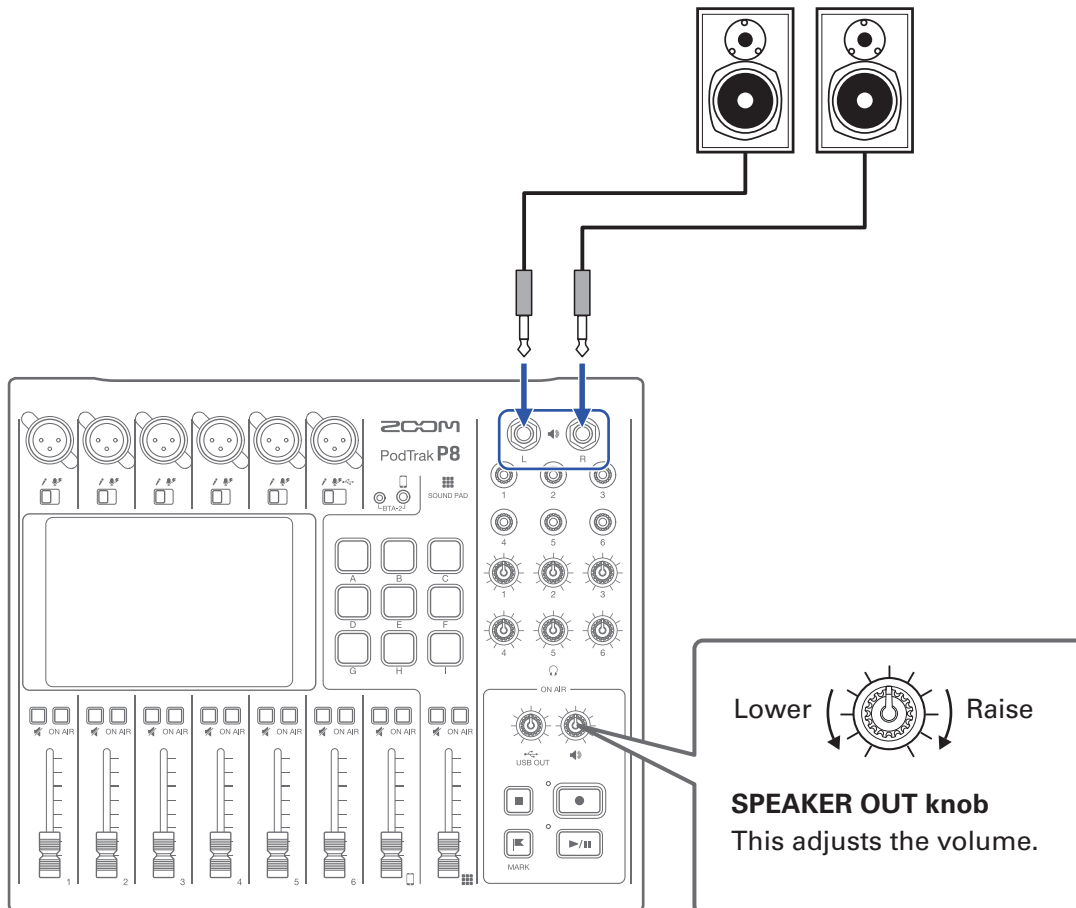

Connect these to the SPEAKER OUT jacks.



Recording

Adjusting input gain and sound quality

Adjust input gain and sound quality so that the levels being recorded neither cause distortion nor are too low.

Tap track buttons ( /  /  / ) on the Home Screen to open their individual settings screens.

Adjusting mic input (tap /)

The following mic input settings can be made.

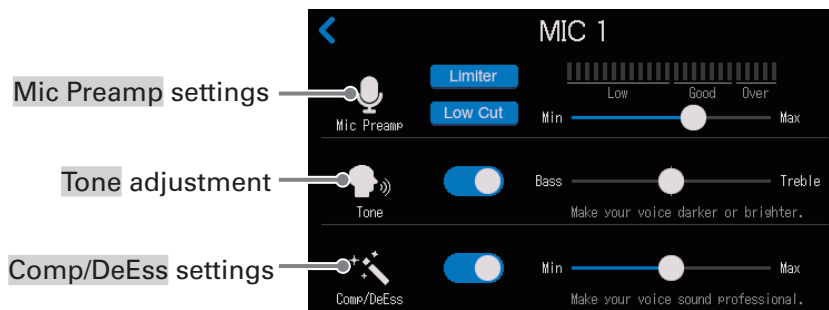

■ Making mic preamp settings

Adjust the input gain, and turn the Low Cut and Limiter on or off.

Limiter setting

When on, the limiter can prevent distortion by reducing input signals that have excessively high levels.

Input level meter

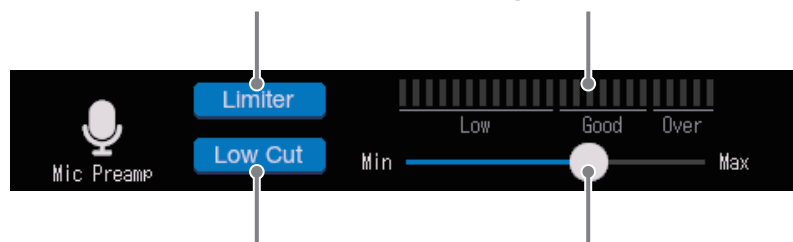

Low Cut setting

When on, this can cut low frequencies to reduce the sound of air conditioning, wind, vocal pops and other noise.

Input gain adjustment

Slide to adjust so the input level meter is in the "Good" range.

HINT

- The level increases when the mic and the speaker's mouth are close and decreases when they are far apart. When recording, maintain the same distance between the mic and the speaker's mouth that was used when the input gain was adjusted. (The standard distance between mic and mouth is 10–20 cm.)
- The input gain adjustment will automatically be reset when the INPUT SELECT switch is changed.

■ Adjusting the tone

This adjusts the tone, emphasizing low or high frequencies in the voice.

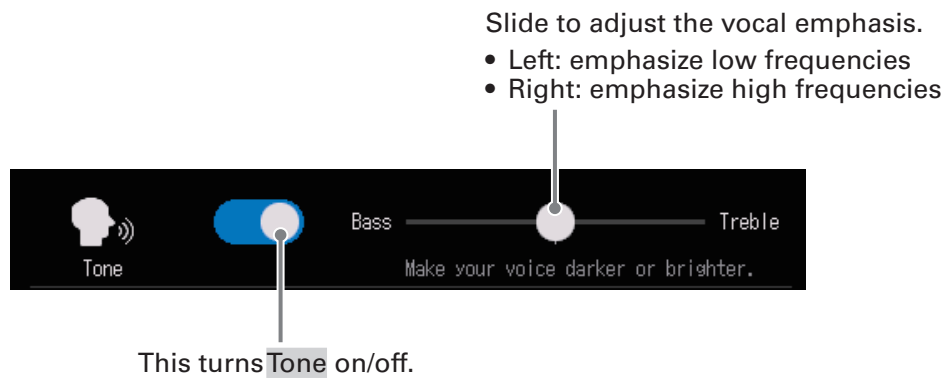

HINT

- With the **P8**, when the slider is in the middle, both low and high frequencies will be slightly emphasized.
 - Double-tap the slider or the bar to reset it to the default value.
-

■ Adjusting the compressor/de-esser

Compressor and de-esser functions can make voices easier to hear. Turn it on or off, and adjust the amount of the effect.

- Compressor: This compresses input sounds when they exceed a set level, making them quieter and evening out the overall volume.
- De-esser: This makes voices sound nicer by suppressing sibilant sounds, which are created through gaps between teeth when “s” sounds are pronounced, for example.

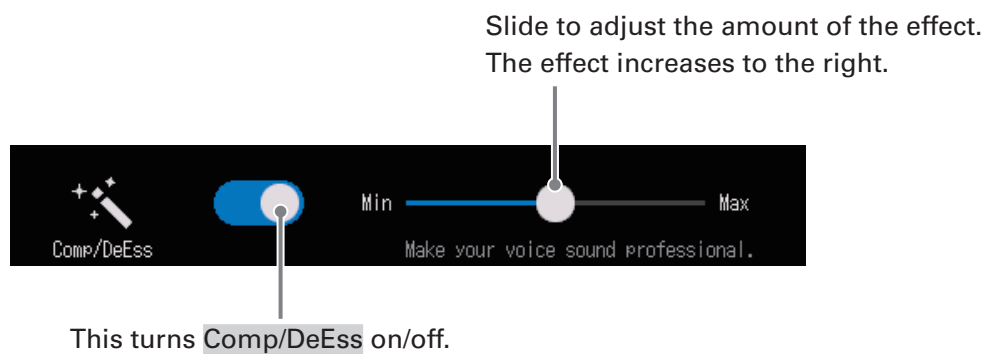

HINT

Double-tap the slider or the bar to reset it to the default value.

Adjusting USB input (tap)

The high and low frequencies of USB input can be boosted and cut to adjust the audio quality.

Slide to adjust high frequencies.

- Left: cut
- Right: boost

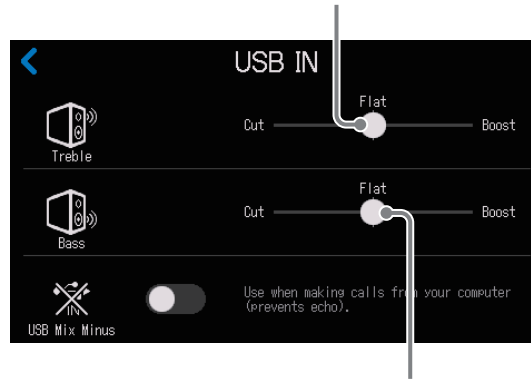

Slide to adjust low frequencies.

- Left: cut
- Right: boost

HINT

Double-tap the slider or the bar to reset it to the default value.

Adjusting smartphone input (tap)

The high and low frequencies of smartphone input can be boosted and cut to adjust the audio quality.

Slide to adjust high frequencies.

- Left: cut
- Right: boost

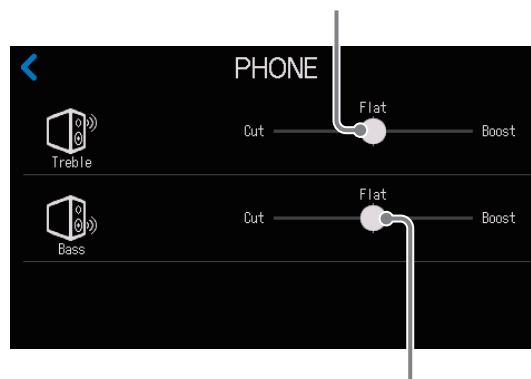

Slide to adjust low frequencies.

- Left: cut
- Right: boost

HINT

Double-tap the slider or the bar to reset it to the default value.

Balancing the mix of channel levels

Use the faders to adjust the balance between channels.

The level meters on the display show the levels. Adjust them so that clipping indicators do not light.

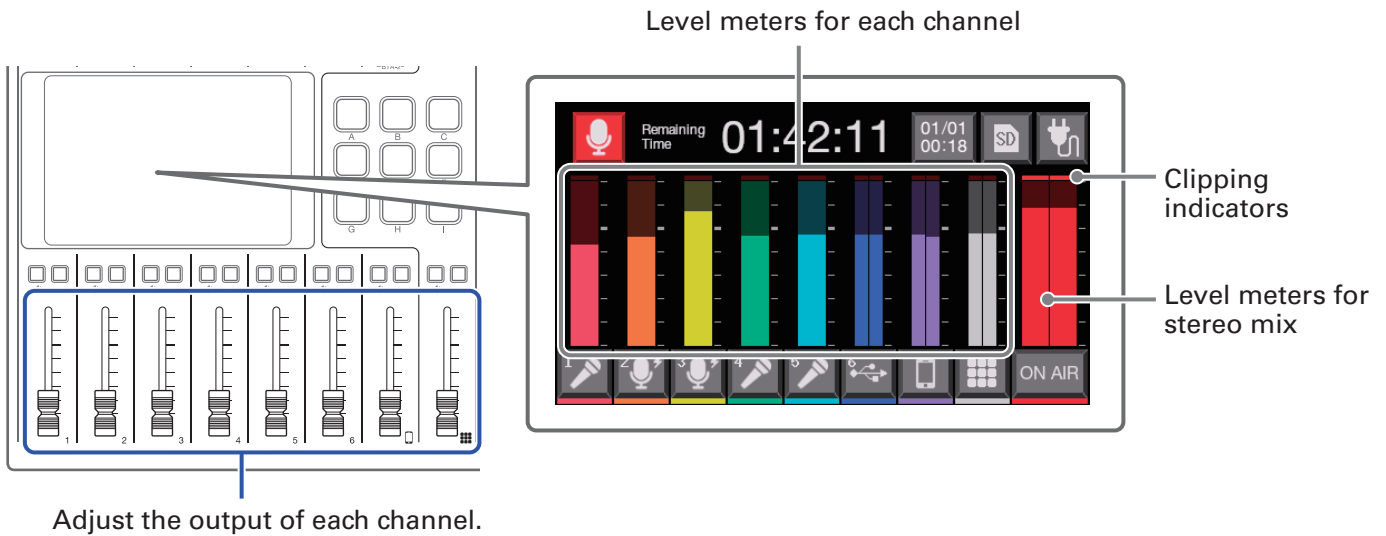

HINT

- Tapping the level meter area will show level guide values.
- Channel 6 is a mono input when it is set to mic input. When USB audio return is being input, (INPUT SELECT switch 6 set to ) , it becomes a stereo input and stereo level meters will be shown.

Recording

In addition to stereo files for podcasting that are mixes of all the channels, each channel can also be recorded as an individual file. The application of effects can also be changed for the individual files of each channel. See [“Setting recording file types” on page 79](#) for file recording settings.

NOTE

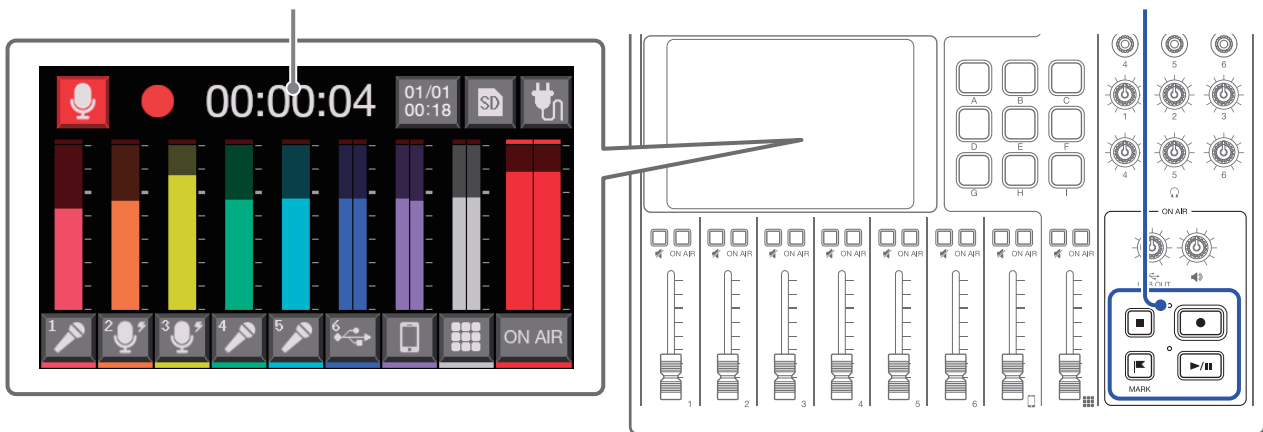

Stereo files for podcasting can be edited. (→ [“Editing files” on page 55](#))

Recording/recording paused: elapsed recording time
Recording stopped: available recording time



1. Press  when the Home Screen is open.

Recording will start and the REC indicator will light red.

Press  when recording to pause recording. (The REC indicator will blink). Press  again to resume recording.



2. Press  or .

Recording will stop.

Press  during recording to add marks to recording files (→ [page 40](#)). These are convenient as guides when editing.

Fader volume adjustments do not affect the individual files of the recorded channels.

HINT

- When the channel 6 INPUT SELECT switch is set to , it will record in stereo.
- Press  to mute a channel that is not being used or to turn off its input temporarily.
- Sound input on channels with  unlit is not recorded to the podcast stereo file. This function is useful, for example, when participants are discussing the next topic among themselves while music is playing.
- Recorded files will be named with the date and time when recording started. This can be changed later. (→ [“Changing file names” on page 57](#))
- See [“P8 folder and file structure” on page 73](#) for the location where recorded files are saved.

Playing recordings

Playing recordings on the Home Screen

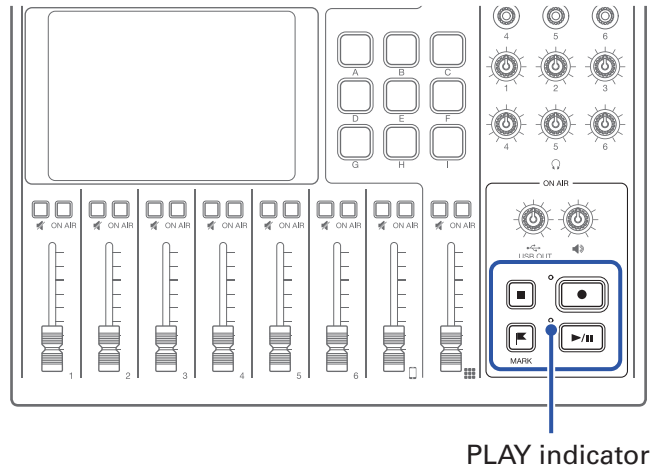

Recorded files can be played back.



1. Press  when the Home Screen is open.

The File Editing Screen appears on the touchscreen and the most recently recorded file starts playing. (The PLAY indicator lights green.)

Press  to start/pause playback alternately. (The PLAY indicator will blink when paused.)

Press  to stop playback. When stopped or paused, press  to return to the beginning of the file.

Mark 

Tap to move the playback position to the mark.
See ["Using marks" on page 40](#) for details about marks.

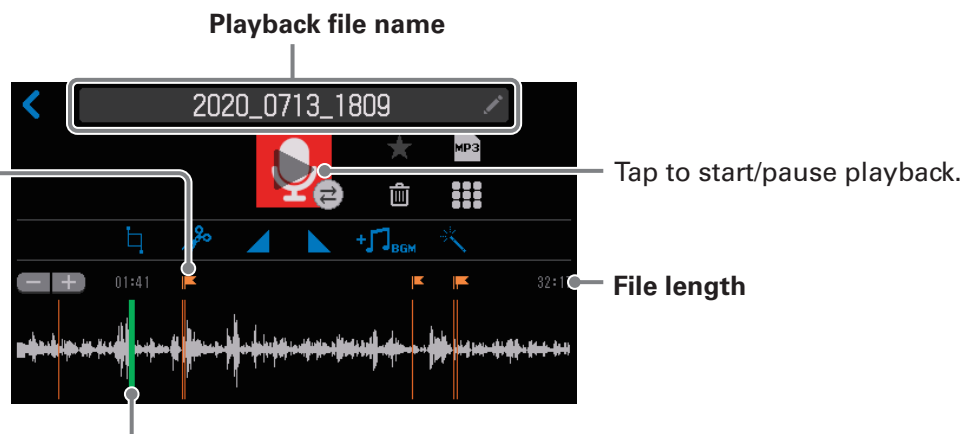

Playback position bar (green)

The elapsed playback time is shown above the playback position bar. Slide the playback position bar or tap the desired position to move the playback position.

HINT

- To select a file and play it back, see ["Selecting files and playing them" on page 38](#).
- On the File Editing Screen, in addition to editing, icons and names can be changed, files can be assigned to SOUND PAD buttons, and files can be converted to MP3 format, for example.

Selecting files and playing them

Files that have been recorded by the **P8** or that are saved on the SD card can be selected and played.

■ File format overview

Select audio files with the following formats.

- Format: WAV
- Sample rate: 44.1 kHz
- Bit rate: 16/24-bit
- Mono/stereo

NOTE

- If a file is not compatible with the **P8**, its name will be gray and it will not be selectable or an error pop-up message will appear when it is selected.
- Files that are not compatible with the **P8** but can be converted will appear on the File List Screen. When they are selected, they can be converted to a compatible file format. Select the file after conversion.
- After the sample rate of a file has been converted to 44.1 kHz, “_441” will be added to the end of the file name.
- After a file has been converted from MP3 to WAV, it will have the same name.
- A new file will be created during conversion, so the original file will remain.

1. Tap  on the Home Screen.

This opens the File List Screen.

2. Tap the audio file you want to play.

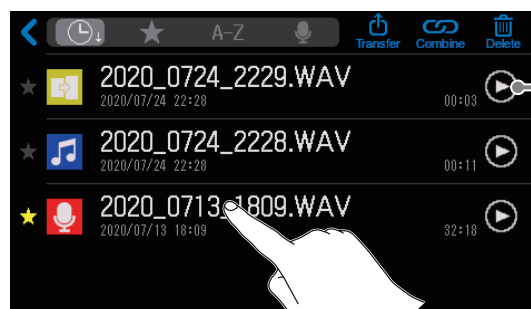

Play button
Tap to start and stop playback.

The editing screen for the selected audio file will be shown.

NOTE

- When using play buttons on the File List Screen to play files, 48kHz, 88.2kHz and 96kHz WAV files can be played, but they will not be played with the correct pitch or speed.
- Play buttons only appear for WAV files.

3. Tap  or press  .

This starts file playback. During playback, the PLAY indicator will light green.

See [“Playing recordings on the Home Screen” on page 37](#) for operations during playback.



HINT

See [“Managing files” on page 49](#) for details about the File List Screen.

Using marks

Marks can be added to recording files during recording (→ [page 36](#)) and when the File Editing Screen is open (→ [page 56](#)). Added marks appear on the File Editing Screen where they can be used as guides and to change the playback position with a single touch.

Adding marks

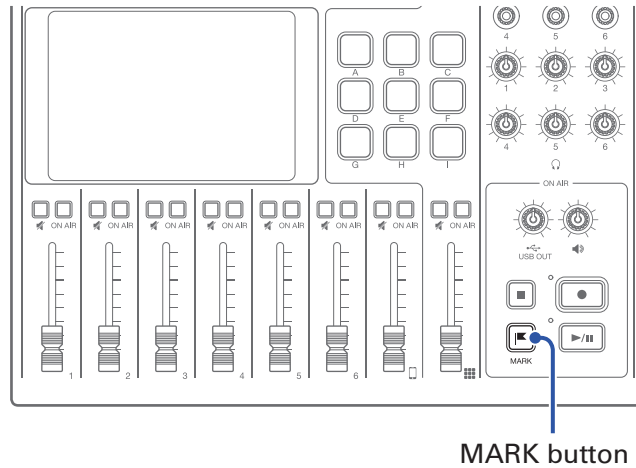

1. Press  during recording and when the File Editing Screen is open.

During recording

When  is pressed a mark is immediately added at the elapsed recording time.

When the File Editing Screen is open

A mark is added at that position on the playback position bar on the File Editing Screen.

Marks can be added when playing, paused and stopped.

File editing screen

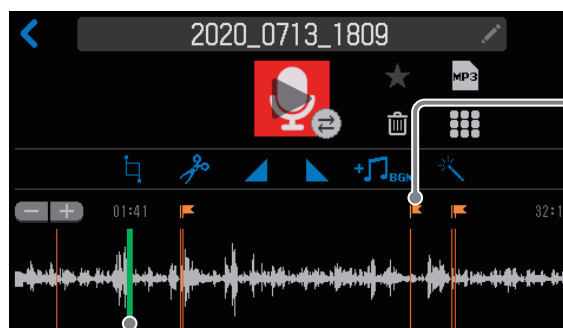

Mark 
Tap to move the playback position to the mark.

Playback position bar

NOTE

Marks cannot be added at the beginnings of files.

Deleting marks

1. When the File Editing Screen is open (→ [page 56](#)), tap or press and hold the  to be deleted.
If pressing and holding, skip to step 3.

File editing screen



2. Press .
3. Tap **Delete**.



The mark will be deleted, and the File Editing Screen will reopen.

Select **Cancel** to cancel deletion.

Using SOUND PAD functions

Audio files can be assigned to the SOUND PAD buttons. Press one to play the assigned file.

The 9 SOUND PAD buttons can have audio files assigned in 4 banks, for a total of 36 files.

This is convenient for playing interviews that have been recorded in advance, opening and ending music and jingles. The level and playback method can be set for each pad.

Playing SOUND PAD buttons

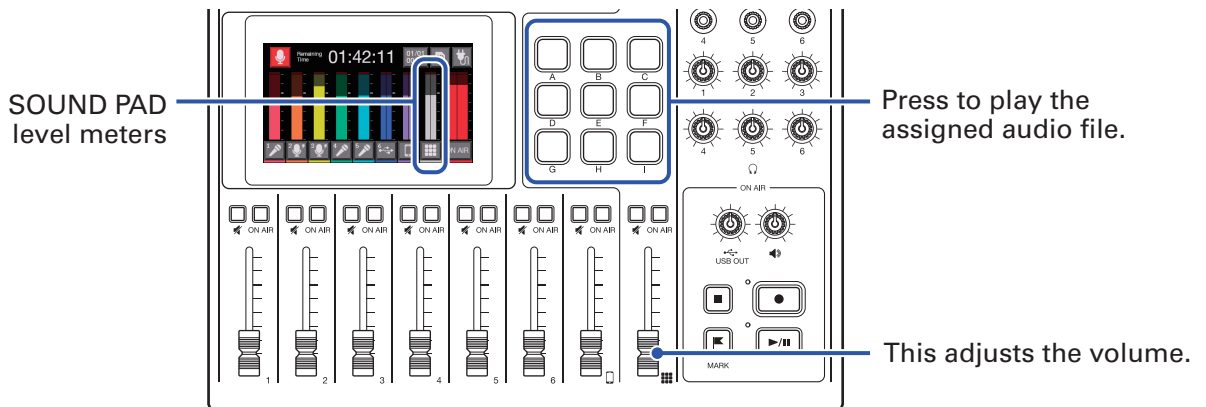

When a SOUND PAD is playing back, that button will blink.

Switching banks

The selected bank will be shown on the SOUND PAD settings screen, and assigned audio files can be checked.

By switching between the 4 banks, a total of 36 audio files can be played.

Bank names can also be changed.

1. Tap  on the Home Screen.

This opens the SOUND PAD settings screen.

2. Switch banks.

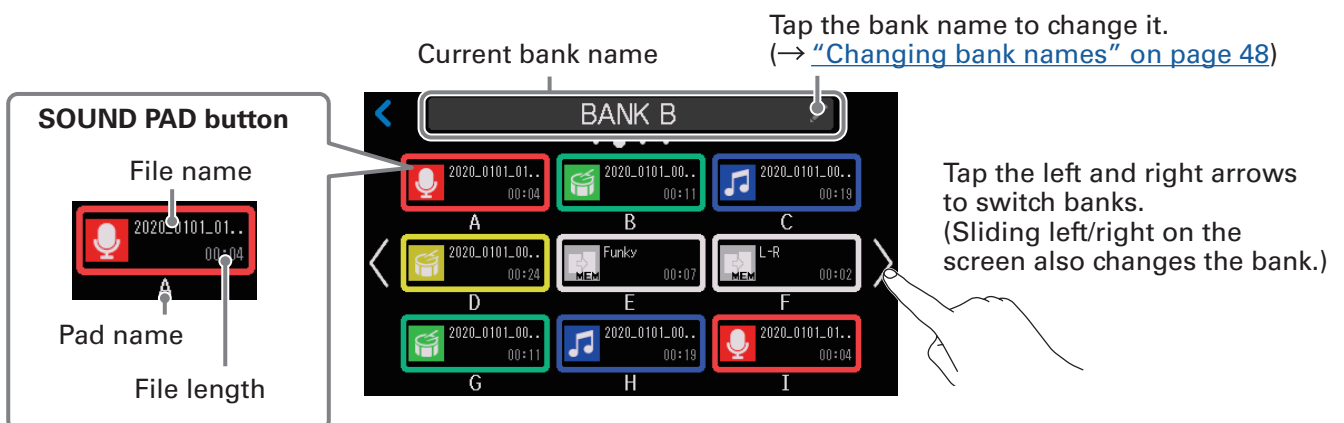

Assigning audio files to SOUND PAD buttons

Built-in sounds and audio files saved on an SD card can be assigned to SOUND PAD buttons.

Use a computer beforehand to store the audio file on the SD card in any directory other than the P8_Multitrack and P8_Settings folders. (→ [“Transferring files to a computer, smartphone or tablet” on page 72](#))

■ File format overview

Assign audio files with the following formats.

- Format: WAV
- Sample rate: 44.1 kHz
- Bit rate: 16/24-bit
- Mono/stereo

NOTE

- If a file is not compatible with SOUND PAD assignment, its name will be gray and it will not be selectable or an error pop-up message will appear when it is selected.
- Files that are not compatible with SOUND PAD assignment but can be converted will appear on the File List Screen. When they are selected, they can be converted to a compatible file format. The new file will be automatically assigned after conversion.
- After the sample rate of a file has been converted to 44.1 kHz, “_441” will be added to the end of the file name.
- After a file has been converted from MP3 to WAV, it will have the same name.
- A new file will be created during conversion, so the original file will remain.
- 88.2kHz and 96kHz WAV files can be assigned to SOUND PAD buttons, but they will not be played with the correct pitch or speed.
- Whether or not 48kHz WAV files are converted to 44.1kHz can be selected. If they are not converted, they can be assigned to SOUND PAD buttons, but they will not be played with the correct pitch or speed.

Assigning audio files on the SOUND PAD settings screen

1. Tap  on the Home Screen.
2. Tap the SOUND PAD button (A-I) to which you want to assign an audio file.
Change the bank as necessary (→ [page 42](#)).

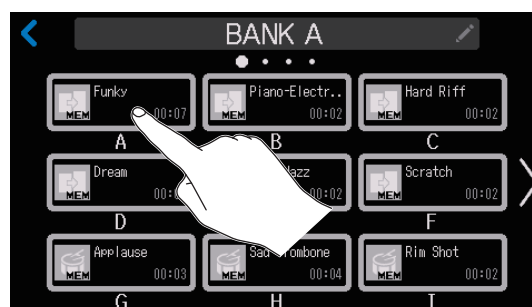

The selected SOUND PAD will light.

3. Tap the file name.

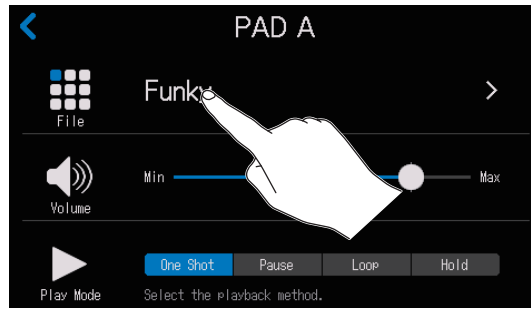

The built-in sound sources and the audio files stored on the SD card are shown in the list.

HINT

Pressing a SOUND PAD will also set it as the button to receive audio file assignment.

4. Tap the audio file that you want to assign.

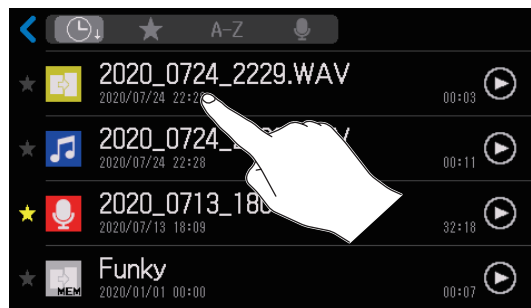

This assigns the selected audio file to the SOUND PAD.

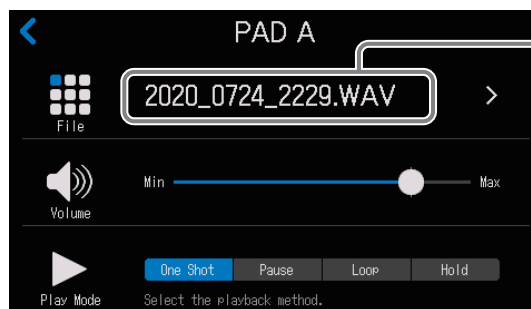

Assigned audio file

HINT

When the Home Screen or SOUND PAD settings screen is open, SOUND PAD buttons that have audio files assigned will light. Since the SOUND PAD buttons will light with the same color as the assigned file icons, setting file icon colors in advance is convenient for identifying playback sounds by color. (→ [“Changing icons” on page 58](#))

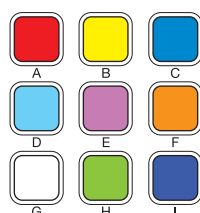

Assigning audio files from the File Editing Screen

1. Tap  on the Home Screen.

2. Tap the audio file that you want to assign.

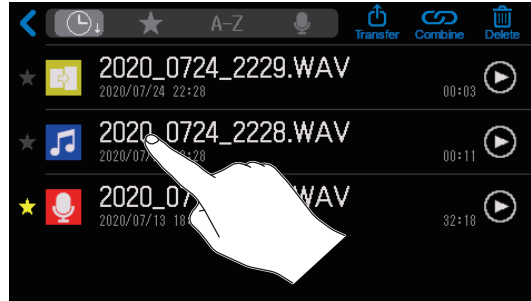

3. Tap .



4. Tap the SOUND PAD button (A-I) to which you want to assign an audio file.

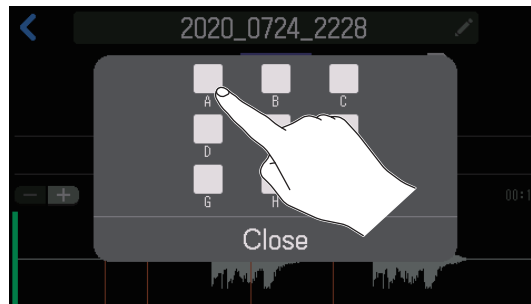

This assigns the file selected in step 2 to the selected SOUND PAD.

Tap **Close** to cancel assignment.

HINT

- This assigns audio files to SOUND PAD buttons in the currently selected bank.
 - When the Home Screen or SOUND PAD settings screen is open, SOUND PAD buttons that have audio files assigned will light.
-

Adjusting the levels of each SOUND PAD

Playback levels can be adjusted separately for each SOUND PAD.
If playback levels differ significantly, they can be made more consistent.

1. Tap  on the Home Screen.
2. Tap the SOUND PAD button (A-I) for which you want to change the level.
Change the bank as necessary (→ [page 42](#)).

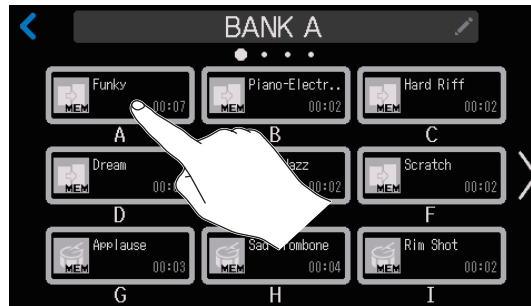

3. Slide to adjust the level.

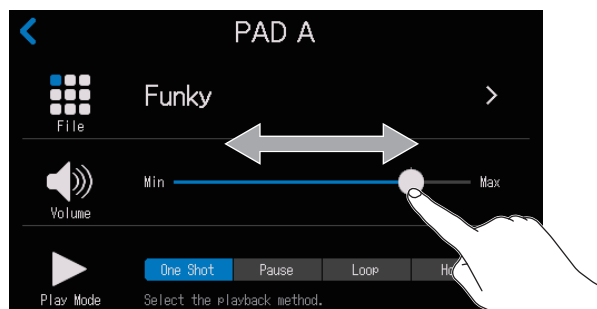

HINT

Double-tap the slider or the bar to reset it to the default value.

Setting playback modes for each SOUND PAD

The sound playback mode used when a SOUND PAD is pressed can be set for each button.

1. Tap  on the Home Screen.
2. Tap the SOUND PAD button (A–I) for which you want to change the playback mode.
Change the bank as necessary (→ [page 42](#)).

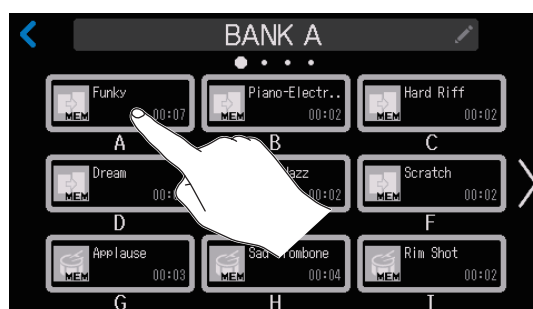

3. Touch the desired playback mode.

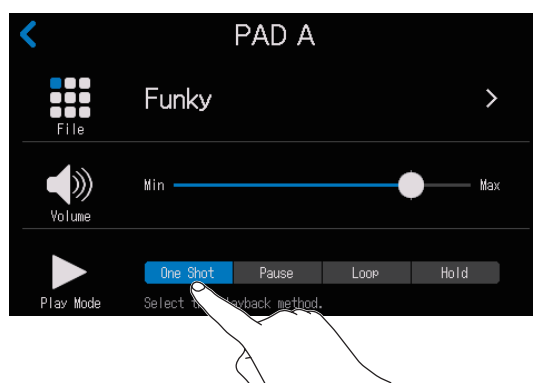

Setting	Explanation
One Shot	Each press plays the file once from beginning to end. This is useful for playing jingles and effect sounds, for example.
Pause	Each press alternately plays and pauses. Playback stops at the end of the file. Press and hold (for 2 seconds) to return to the beginning. This is useful for interrupting to add commentary during SOUND PAD playback.
Loop	Each press alternately plays and stops. Playback will loop until stopped. This is useful for playing background music, for example.
Hold	While pressing, loop playback will continue. When released, playback will stop. This is useful for playing effects for just the time desired.

Changing bank names

The default names of the SOUND PAD banks, which are “BANK A” – “BANK D”, can be changed.

1. Tap  on the Home Screen.

2. Tap .

Change the bank as necessary (→ [page 42](#)).



3. Input the bank name.

See [“Character input screen” on page 16](#) for details about character input.

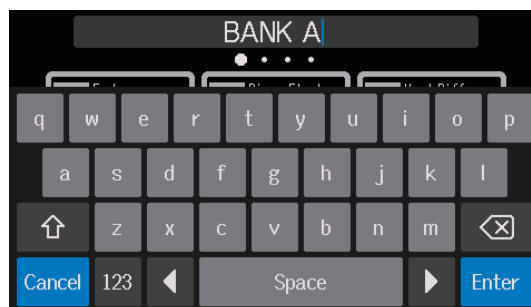

Managing files

Manage files on the File List Screen. On the File List Screen, a list of the audio files on the SD card is shown, and files can be selected, combined and deleted.





NOTE

- Audio files that are not in the P8_Multitrack or P8_Settings folders will be shown.
- Individual channel recording files will not be shown in the list, and cannot be edited on the **P8**.
- The **P8** built-in sounds will only be shown on the File List Screen if they have been assigned to SOUND PAD buttons.
- When the File List Screen is open, the channel input signals and sounds played when SOUND PAD buttons are pressed will stop being output from the **P8**.

1. Tap  on the Home Screen.
This opens the File List Screen.

Sort category selection buttons

Tap to sort the files in that order.

-  File creation date/time order
-  Favorites/others
-  File name order
-  Icon order

Tapping the same button alternates between ascending and descending order.

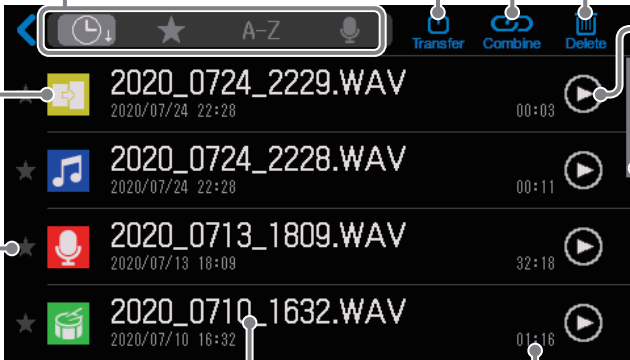

Activate USB file transfer mode. (→ [page 72](#))

Combine multiple files into one. (→ [page 52](#))

Delete files. (→ [page 50](#))

Play button
Tap to start and stop playback.

Scrollbar
Slide this bar to scroll the list.
Sliding the list itself will also scroll it.

File length







File icon
This can be changed.
(→ [page 58](#))

Favorite mark
Tap to add/remove as a favorite
This will be highlighted if added.

File name
Tap to open the editing screen for the selected file where it can be played (→ [page 37](#)) and edited (→ [page 55](#)).
The creation date and time is shown below the file name.

File icons

The following default icons are shown for audio files.

File type	Icon
File recorded by the P8	
Episode file that is a combination of multiple files	
WAV file saved on the SD card from an outside source	
Built-in P8 sound	
MP3 file	
File other than WAV or MP3	

Deleting files

Unneeded files can be deleted.

1. Tap  on the Home Screen.

2. Tap .

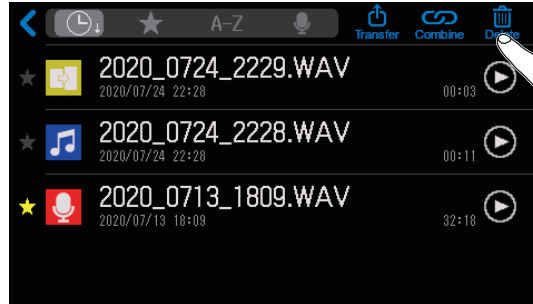



3. Tap one or more files that you want to delete.

Check marks will appear on selected files.

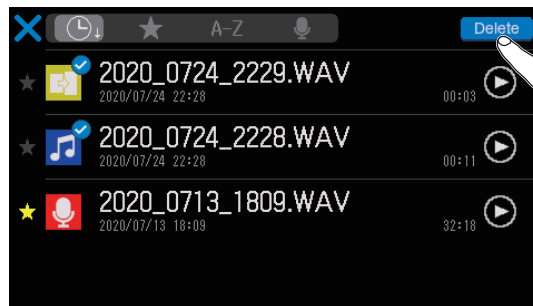

4. Tap .



Tap  to clear the selection and return to the File List Screen.

5. Tap **Delete**.

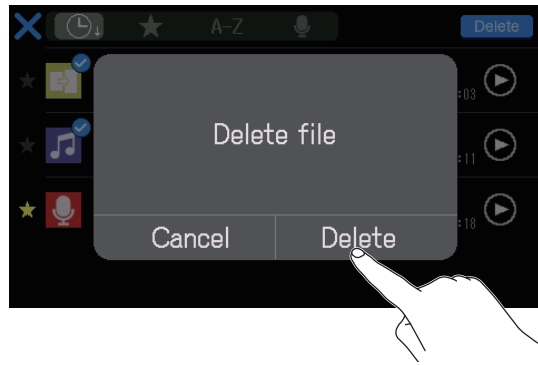

The selected file will be deleted, and the File List Screen will reopen.

Select **Cancel** to cancel deletion.

Combining multiple files into one in specific order

Multiple files can be combined to create one file for distribution.

Regular openings and endings can be added to episodes, and short sound effects can be inserted for scene changes between conversations.

Combination example



■ File format overview

Audio files in the following formats can be combined.

- Format: WAV
- Sample rate: 44.1 kHz
- Bit rate: 16/24-bit
- Mono/stereo

NOTE

- When combining files, the names of unsupported files will be gray and they will not be selectable or an error pop-up message will appear when one is selected.
- Some files that are not supported when combining can be selected on the File List Screen and converted to a compatible file format in advance. After conversion, such files can be combined.

1. Tap  on the Home Screen.

2. Tap .

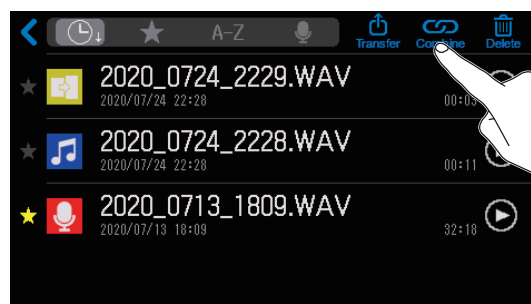

3. Tap the files to be combined.

The selected files are shown in the order that they will be combined into one file. The leftmost file will be the first.

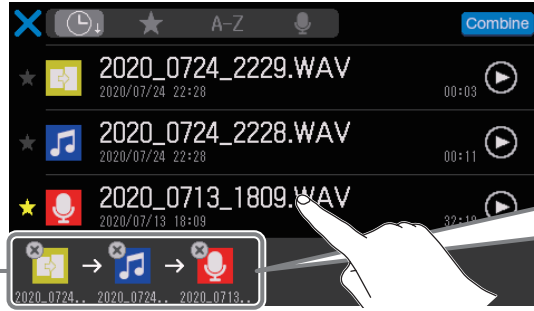

Tap to cancel a selection.

Press and hold an icon and then slide it to move it. A vertical line will show the input position.

NOTE

- The same file can be selected multiple times.
- If the selected files cannot all be shown on the screen, slide the bottom of the screen left and right to scroll through them.
- Up to 20 files can be combined at once. When 20 files have been selected, the names of all files will become gray and unselectable on the File List Screen.

4. Tap **Combine**.

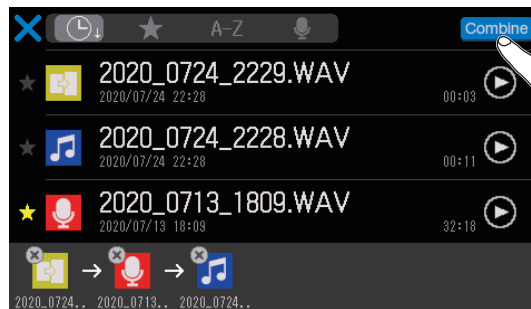

Tap to cancel combining files and return to the File List Screen.

5. Tap **Combine**.

Name of the combined file

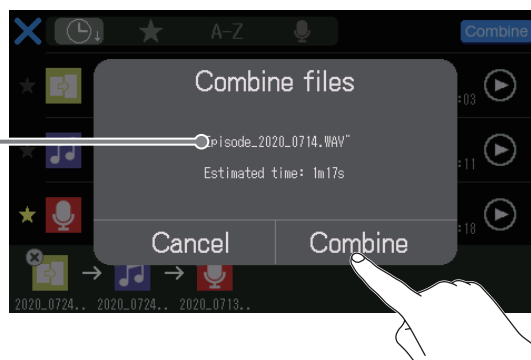

Select **Cancel** to cancel combining.

6. Tap Close.

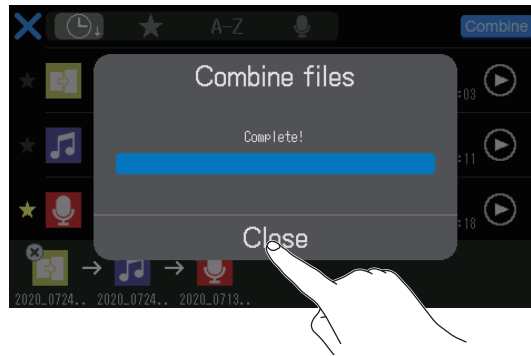

A new episode file that combines the selected files into one will be created, and the File List Screen will reopen.

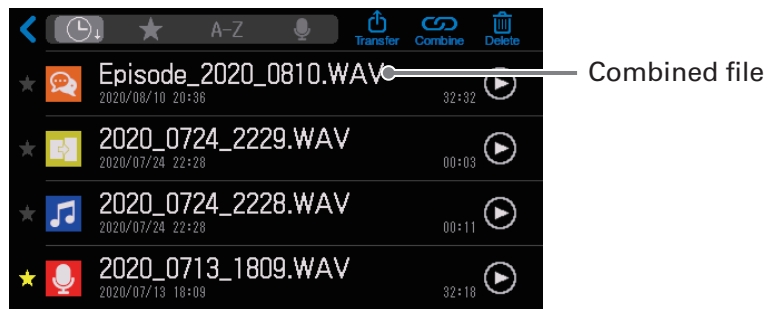

Editing files

The **P8** can be used to edit the podcast stereo file that is a mix of all channels.

■ File format overview

Files with the following formats can be edited.

- Format: WAV
- Sample rate: 44.1 kHz
- Bit rate: 16/24-bit
- Mono/stereo

NOTE

- Individual channel files cannot be edited.
- If a file is not compatible with the **P8**, its name will be gray on the File List Screen and it will not be selectable or an error pop-up message will appear when it is selected.
- Files that are not compatible with the **P8** but can be converted will appear on the File List Screen. When they are selected, they can be converted to a compatible file format. Select the file after conversion.
- After the sample rate of a file has been converted to 44.1 kHz, “_441” will be added to the end of the file name.
- After a file has been converted from MP3 to WAV, it will have the same name.
- A new file will be created during conversion, so the original file will remain.

On the File Editing Screen, the waveform of the audio file is shown and the following operations are possible.

- Change icon (→ [“Changing icons” on page 58](#))
- Cut unnecessary parts (→ [“Cutting unnecessary parts \(trimming\)” on page 59](#))
- Divide file (→ [“Dividing files” on page 61](#))
- Add fade-in/out (→ [“Adding fade-ins and outs” on page 63](#))
- Add background music (→ [“Adding music and other background sound” on page 66](#))
- Apply loudness normalization (→ [“Optimizing podcast volume \(loudness normalization\)” on page 69](#))
- Convert to MP3 (→ [“Converting files to MP3 format” on page 71](#))
- Change file name (→ [“Changing file names” on page 57](#))
- Add to favorites (→ [“Opening the File Editing Screen” on page 56](#))
- Delete file (→ [“Opening the File Editing Screen” on page 56](#))
- Assign to SOUND PAD button (→ [“Assigning audio files from the File Editing Screen” on page 45](#))

Opening the File Editing Screen

1. Tap  on the Home Screen.
This opens the File List Screen.
2. Tap the file you want to edit.

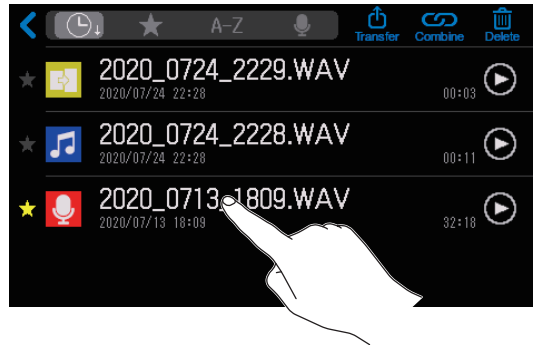

This opens the File Editing Screen.

Waveform zoom in/out buttons

 This zooms in on the waveform. This makes precise editing easier.

 This zooms out from the waveform. This is useful for checking the entire waveform.

Playback position bar

This shows the playback and editing positions. The elapsed time is shown above the bar.

Slide the bar or tap the waveform to move the playback position.

Mark 

Tap to move to the mark position on the position display bar.

Marks can also be added and removed while editing. (→ [page 40](#))





File name





Change the icon. (→ [page 58](#))

Change the file name. (→ [page 16](#))

Waveform display

Press to open these editing screens.

-  Cut unnecessary parts (→ [page 59](#))
-  Divide files (→ [page 61](#))
-  Fade-in/out (→ [page 63](#))
-  Add background music (→ [page 66](#))
-  Even out volume (→ [page 69](#))

-  Tap to add/remove as a favorite. This will be highlighted if added.
-  Tap this and **Delete** to delete the file.
-  Convert to MP3 (→ [page 71](#)).
-  Assign to SOUND PAD (→ [page 45](#)).

NOTE

When the File Editing Screen is open, the channel input signals and sounds played when SOUND PAD buttons are pressed will stop being output from the **P8**.

Changing file names

When files are recorded on the **P8**, they are named with the recording start date and time. These names can be changed later. Only the names of files that have been recorded on the **P8** can be changed.

1. Open the editing screen for the file with the name you want to change (→ [“Opening the File Editing Screen” on page 56](#)).

2. Tap .



3. Input the file name.

See [“Character input screen” on page 16](#) for details about character input.

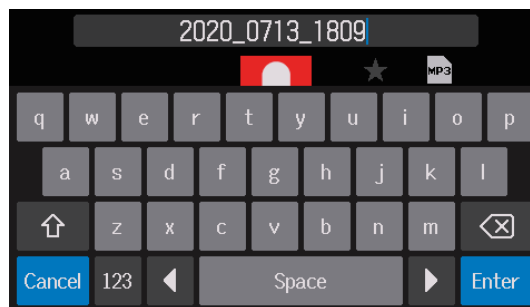

Changing icons

The file icon that is shown on the File List Screen and File Editing Screen can be changed. The SOUND PAD buttons light with the same colors as the file icons.

1. Open the editing screen for the file with the icon you want to change (→ [“Opening the File Editing Screen”](#) on page 56).

2. Tap .



3. Change the icon.



4. Tap **Close**.

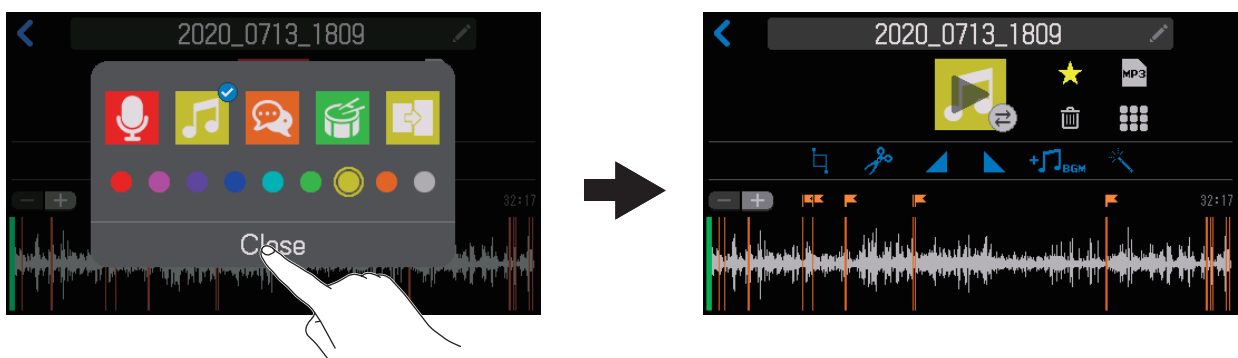

Cutting unnecessary parts (trimming)

Unnecessary parts of files can be cut.

1. Open the editing screen for the file that you want to trim (→ [“Opening the File Editing Screen” on page 56](#)).
2. Tap .



3. Slide cut points A and B to set them, and tap **Execute**.
Parts before cut point A and after cut point B (shown in gray) will be deleted.

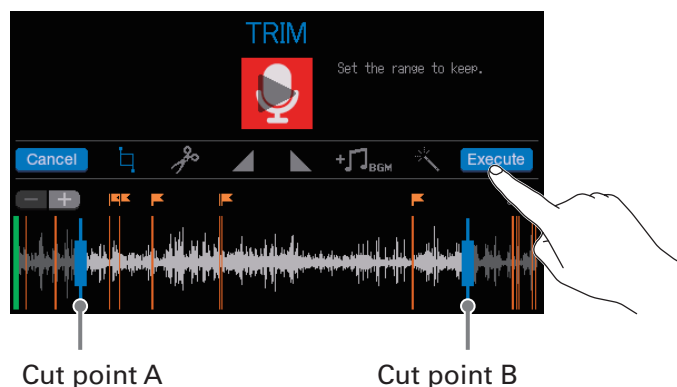

Tap **Cancel** to cancel trimming.

HINT

- Files can be edited while they are played. See [“Playing recordings on the Home Screen” on page 37](#) for playback procedures.
 - Tap  to zoom the waveform display, enabling precise setting of the points.
-

4. Tap Save.

Tap to add a check to create a new file after trimming (and keep the untrimmed file as is).

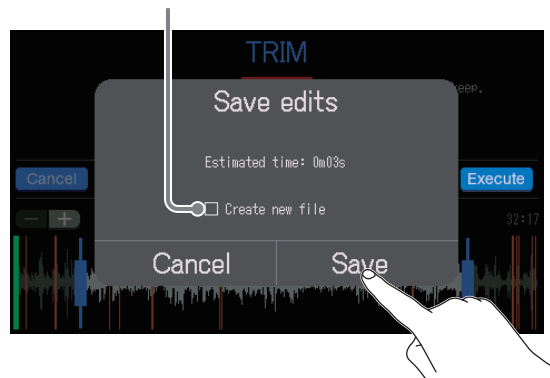

Select **Cancel** to cancel trimming.

5. Tap Close.

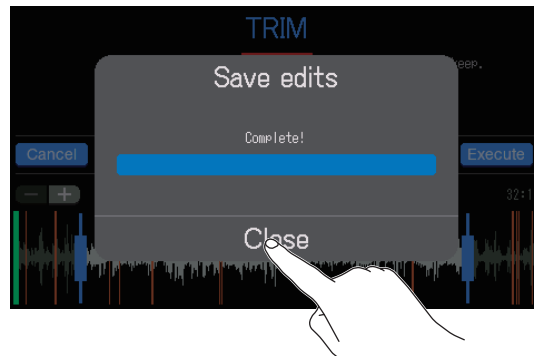

HINT

- If the original file has marks, mark data will be retained in the file after trimming.
 - If a new file is created after trimming, “_TRIM” will be added to the end of the file name.
-

Dividing files

Files can be split where desired.

1. Open the editing screen for the file you want to divide (→ [“Opening the File Editing Screen”](#) on page 56).

2. Tap .

The file will be divided at the position on the playback position bar.



3. Set the file division points, and tap **Execute**.

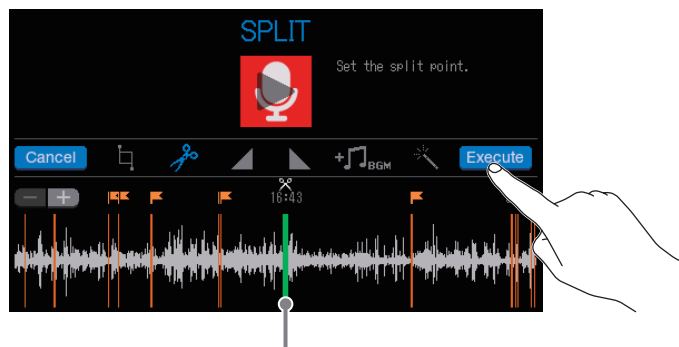

File division point

Tap **Cancel** to cancel division.

■ Setting file division points

Tap a point on the waveform to set the file division point there.

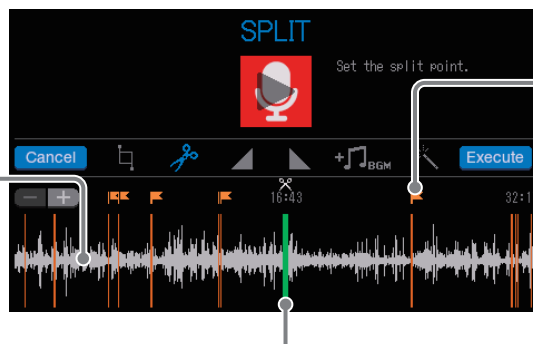

Slide to set the file division point.

Tap a mark to set it as the file division point.

HINT

- Files can be edited while they are played. See [“Playing recordings on the Home Screen”](#) on page 37 for playback procedures.
- Tap  to zoom the waveform display, enabling precise setting of the points.

4. Tap Save.

Tap to add a check to create new files after division (and keep the undivided file as is).

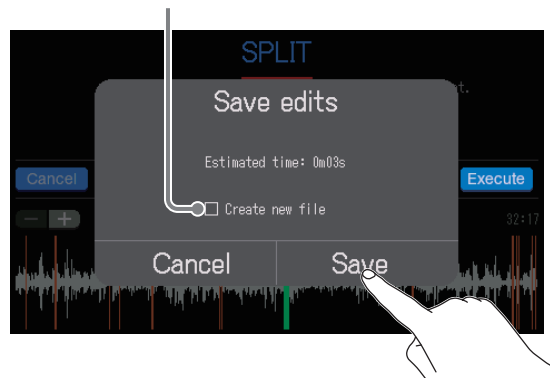

Select **Cancel** to cancel division.

5. Tap Close.

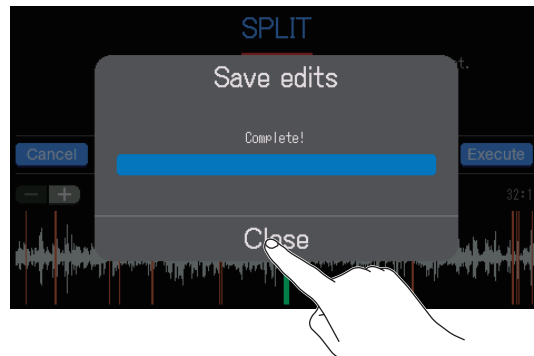

HINT

- If the original file has marks, mark data will be retained in the files after division.
 - After division, the file created from before the division point will have “_A” added to the end of the file name, and the file created after the division point will have “_B” added.
-

Adding fade-ins and outs

The volume can be gradually raised from silence at the beginning of a file (fade in) and gradually lowered to silence at the end of a file (fade out).

Fade-ins and fade-outs can even be set in the middle of a file.

Fade in

1. Open the editing screen for the file to which you want to add a fade in (→ [“Opening the File Editing Screen”](#) on page 56).

2. Tap .



3. Slide the fade-in frame to set the desired range, and tap **Execute**.



Fade-in range
The fade in will occur over this time.

Tap **Cancel** to cancel adding a fade-in.

HINT

- The file can be played to check the fade-in. See [“Playing recordings on the Home Screen”](#) on page 37 for playback procedures.
- Tap  to zoom the waveform display, enabling precise setting of the points.

4. Tap **Save**.

Tap to add a check to create a new file with the fade-in effect (and keep the file without the effect as is).

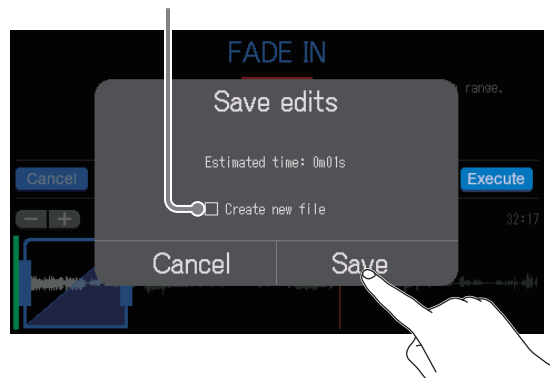

Select **Cancel** to cancel adding a fade-in.

5. Tap **Close**.

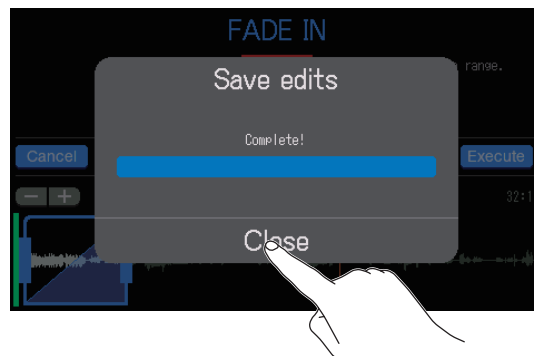

HINT

If a new file is created after adding a fade-in, “_FADEIN” will be added to the end of the file name.

Fade out

1. Open the editing screen for the file to which you want to add a fade out (→ [“Opening the File Editing Screen”](#) on page 56).

2. Tap .



3. Slide the fade-out frame to set the desired range, and tap **Execute**.

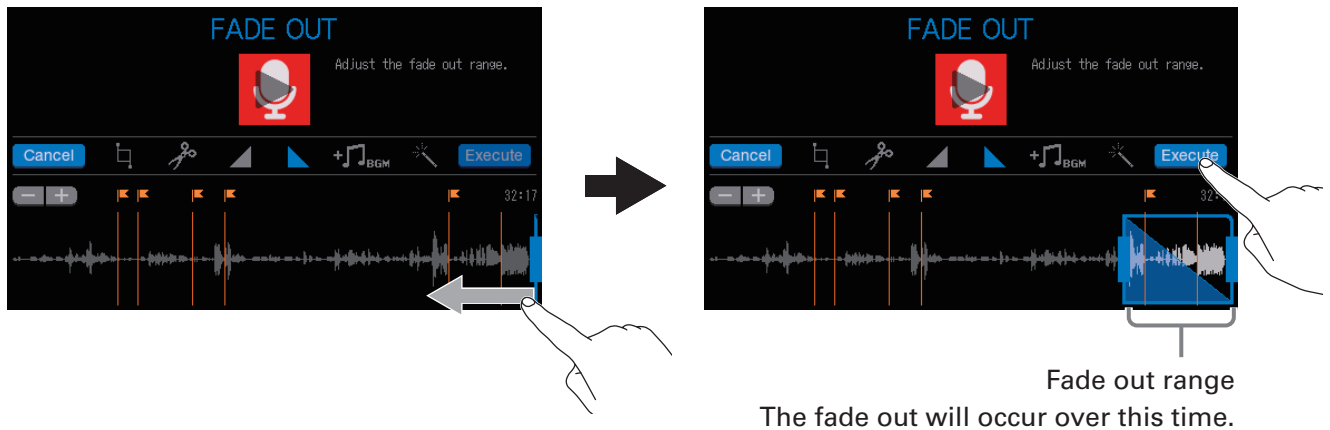

Tap **Cancel** to cancel adding a fade-out.

HINT

- The file can be played to check the fade-out. See [“Playing recordings on the Home Screen” on page 37](#) for playback procedures.
- Tap **+** to zoom the waveform display, enabling precise setting of the points.

4. Tap **Save**.

Tap to add a check to create a new file with the fade-out effect (and keep the file without the effect as is).

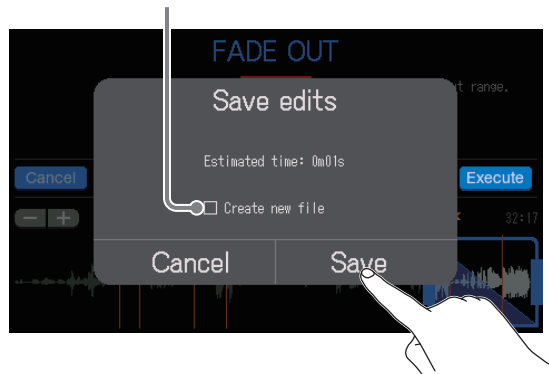

Select **Cancel** to cancel adding a fade-out.

5. Tap **Close**.

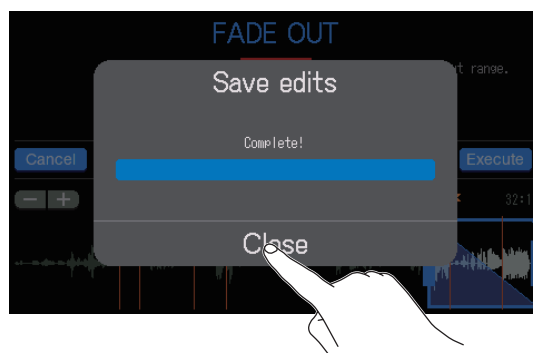

HINT

If a new file is created after adding a fade-out, “_FADEOUT” will be added to the end of the file name.

Adding music and other background sound

Background music (BGM) can be added to audio files.

Use a computer beforehand to store the audio file to be used for BGM on the SD card in any directory other than the P8_Multitrack and P8_Settings folders. (→ [“Transferring files to a computer, smartphone or tablet” on page 72](#))

■ File format overview

Select an audio file with the following format for BGM.

- Format: WAV
- Sample rate: 44.1 kHz
- Bit rate: 16/24-bit
- Mono/stereo

NOTE

- The currently selected file cannot also be added as BGM. The file name will appear gray.
- If a file is not compatible as BGM, its name will be gray and it will not be selectable or an error pop-up message will appear when it is selected.
- Some files that are not supported as BGM can be selected on the File List Screen and converted to a compatible file format in advance. After conversion, such files can be used as BGM.

1. Open the editing screen for the file to which you want to add BGM (→ [“Opening the File Editing Screen” on page 56](#)).

2. Tap .



3. Tap .

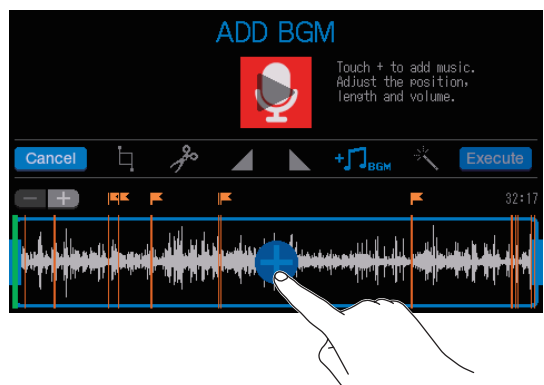

4. Tap the file to add as BGM.

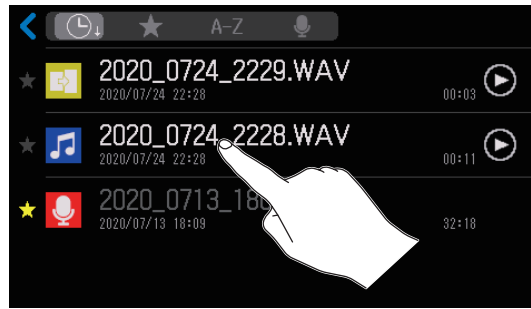

5. Set the area where the BGM will be added, adjust its volume, and tap **Execute**.

Slide up and down to set the BGM volume.

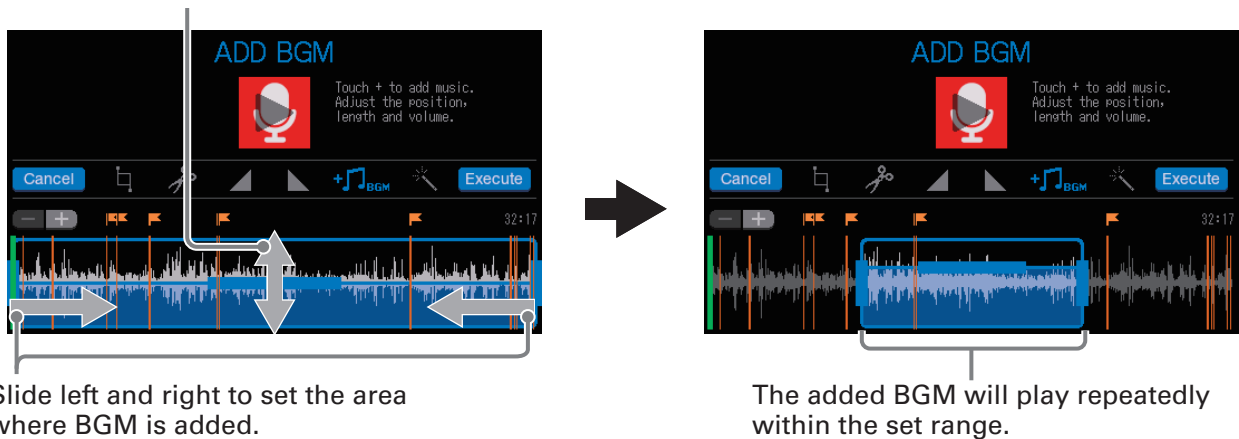

Slide left and right to set the area where BGM is added.

The added BGM will play repeatedly within the set range.

Tap **Cancel** to cancel adding BGM.

HINT

- The file can be played to check the effect of adding the BGM. See [“Playing recordings on the Home Screen” on page 37](#) for playback procedures.
- During file playback, only the BGM volume can be changed.
- Tap **+** to zoom the waveform display, enabling precise setting of the points.

6. Tap **Save**.

Tap to add a check to create a new file after adding BGM (and keep the file without BGM as is).

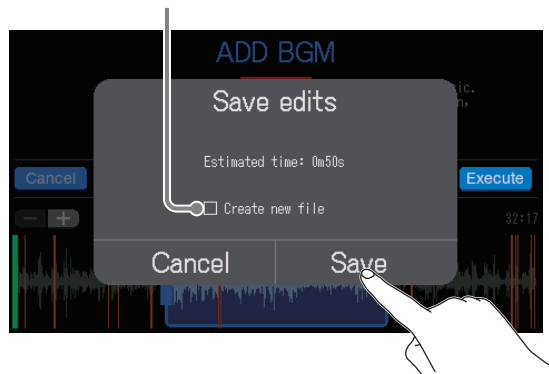

Select **Cancel** to cancel adding BGM.

7. Tap Close.



HINT

If a new file is created with BGM, “_BGM” will be added to the end of the file name.

Optimizing podcast volume (loudness normalization)

The loudness level of the entire file can be analyzed and the volume automatically optimized for podcasting.

1. Open the editing screen for the file for which you want to optimize the volume (→ [“Opening the File Editing Screen”](#) on page 56).

2. Tap .



3. Tap **Execute**.



Tap **Cancel** to cancel loudness normalization.

4. Tap **Save**.

Tap to add a check to create a new file after loudness normalization (and keep the file before loudness normalization as is).

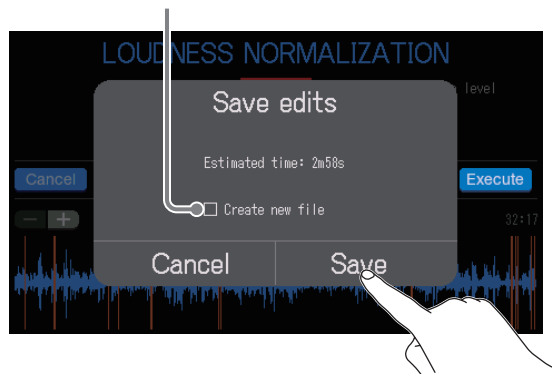

Select **Cancel** to cancel loudness normalization.

5. Tap Close.

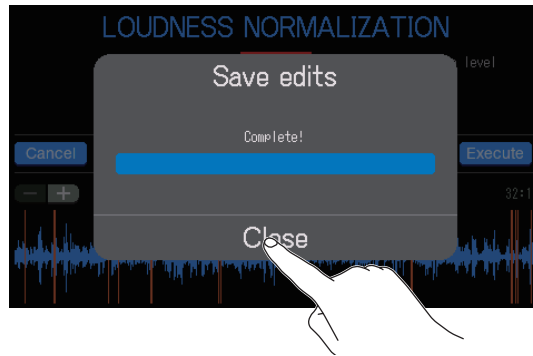

HINT

If a new file is created after loudness normalization, “_NORM” will be added to the end of the file name.

Converting files to MP3 format

WAV files recorded on the **P8** can be converted to MP3 format for podcasts.

1. Open the editing screen for the file you want to convert to MP3 format (→ [“Opening the File Editing Screen”](#) on page 56).

2. Tap .



3. Tap **Export**.

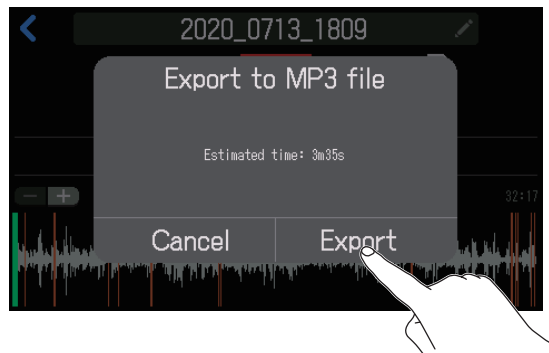

Select **Cancel** to cancel MP3 conversion.

4. Tap **Close**.

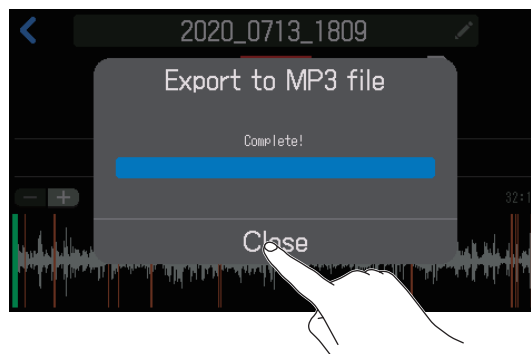

HINT

After a file has been converted from WAV to MP3, it will have the same name.

Transferring files to a computer, smartphone or tablet

The input signals of each channel and the sounds played by pressing the SOUND PAD buttons are recorded as separate files. Various editing functions can be used on them after recording by transferring them to a computer or other device. For example, their mix balance can be adjusted, effects can be added, and lengths can be changed. After editing them, upload them to the podcasting service or server you are using.

Transferring files to a computer, smartphone or tablet

Recorded files can be transferred to computers, smartphones and tablets.

1. Tap  on the Home Screen.

2. Tap .

This opens the **USB FILETRANSFER** screen.

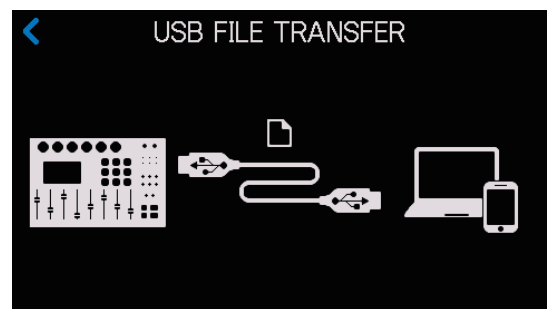
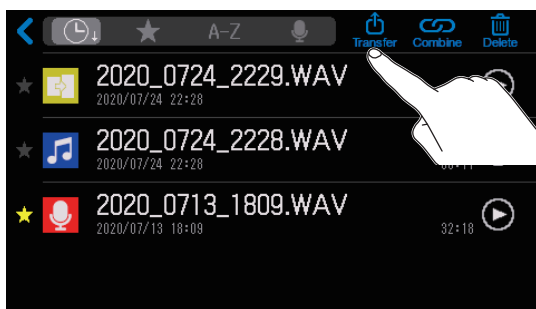



3. Use a USB cable to connect the **P8** with a computer, smartphone or tablet (→ [“Connecting a computer, smartphone or tablet by USB” on page 28](#)).

When connecting a smartphone or tablet, turn **Tablet Mode** on. (→ [“Preparing to connect a smartphone or tablet” on page 29](#))

4. Use the computer or other device to transfer the necessary files.

NOTE

- When the **USB FILETRANSFER** screen is open, other functions and buttons cannot be used. Moreover, the channel input signals and sounds played when SOUND PAD buttons are pressed will stop being output from the **P8**.
- The **USB FILETRANSFER** screen can also be opened from the Home Screen by tapping  to open the **SD CARD** screen, and tapping .

P8 folder and file structure

When recording with the **P8**, folders and files are created on SD cards in the following manner.

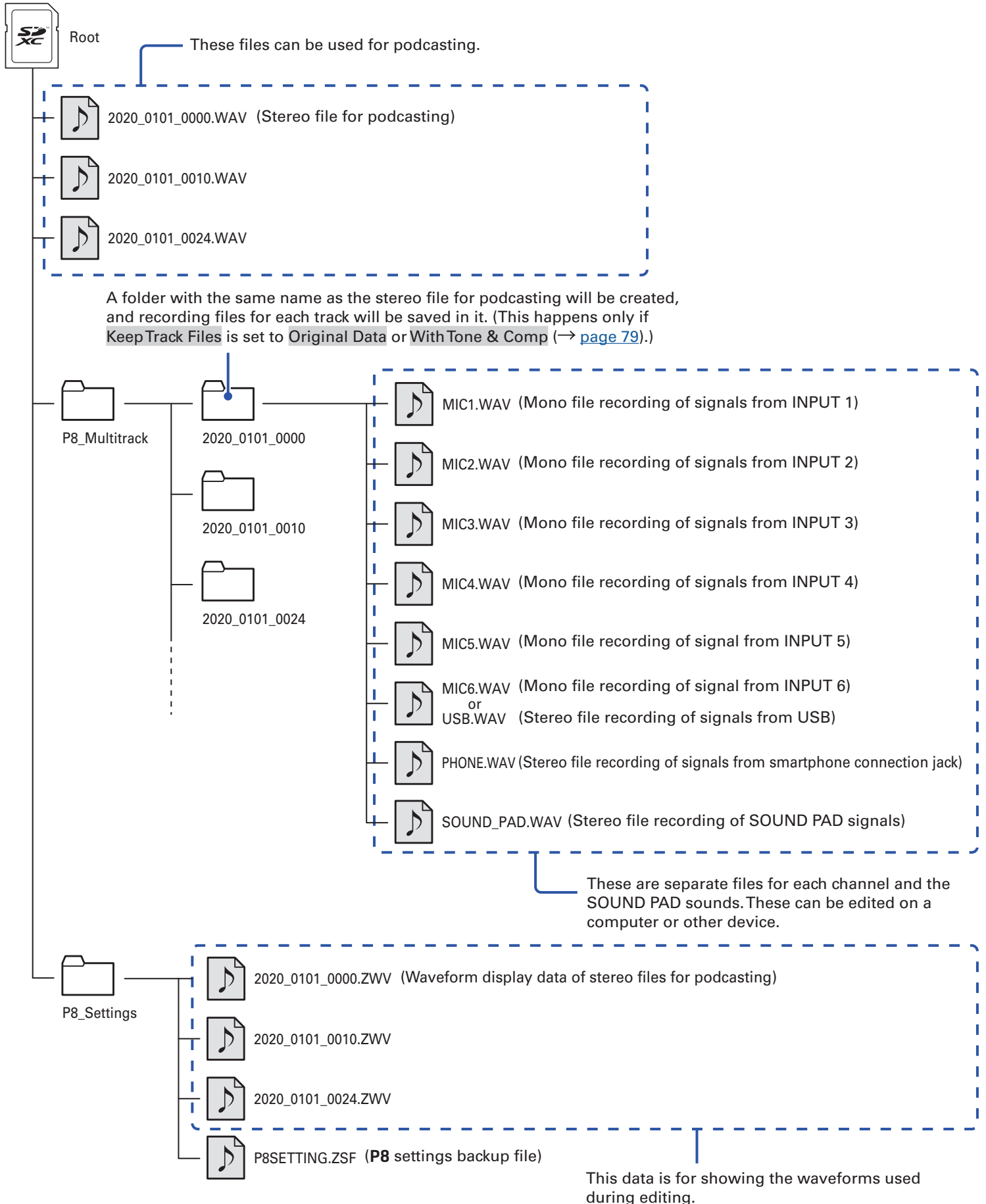

Modifying the date and time

The date and time are stored in recorded files, and the date and time recording started are used in the file name. Having the correct date and time set is helpful when looking for files, for example, by allowing content to be identified by names.

1. Tap the date and time display (**01/01**
00:00) on the Home Screen.
2. Tap **▲** and **▼** to set the **Year**, **Month**, **Day**, **Hour**, and **Minute**.

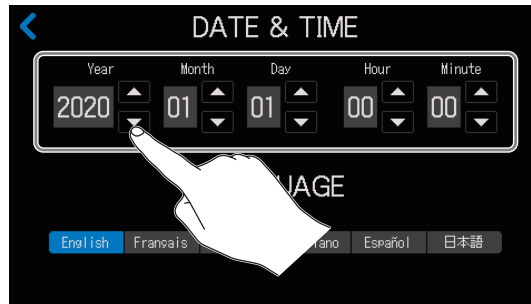

Changing the touchscreen display language



The language used on the touchscreen can be changed.

1. Tap the date and time display (`01/01 00:00`) on the Home Screen.
2. Tap the language to be shown on the touchscreen.



Setting the battery type

Set the type of battery used correctly so that the amount of remaining battery charge can be shown accurately.

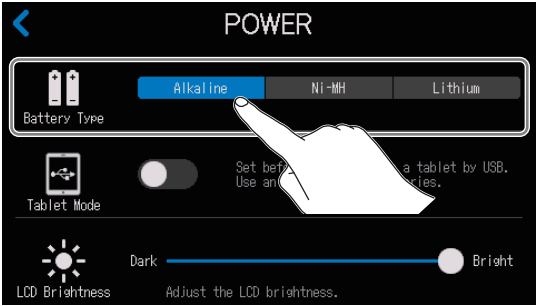

1. Tap the  /  /  power button on the Home Screen.
2. Tap the type of battery used.



Setting	Explanation
Alkaline	Alkaline batteries
Ni-MH	Nickel-metal hydride batteries
Lithium	Lithium batteries

Adjusting the brightness of the touchscreen

The brightness of the touchscreen can be adjusted.

1. Tap the  /  /  power button on the Home Screen.
2. Slide to adjust the brightness of the touchscreen.

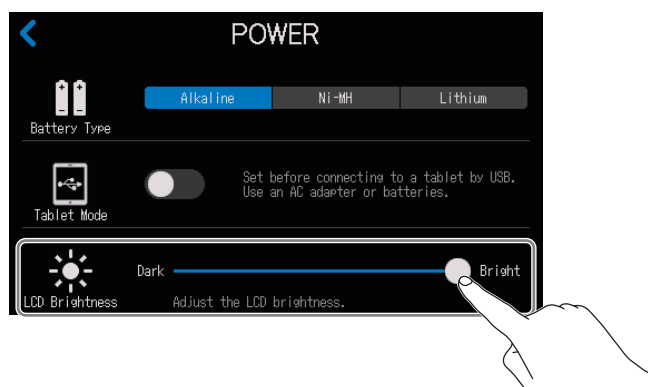

HINT

Double-tap the slider or the bar to reset it to the default value.

Using noise reduction

Noise Reduction can be turned on or off.

When multiple mics are being used to record sound, the noise reduction function of the **P8** suppresses background noise to a constant level by automatically reducing the levels of the mic inputs not being used by people.

1. Tap **ON AIR** on the Home Screen.
2. Tap the ON/OFF button to turn **Noise Reduction** on or off.

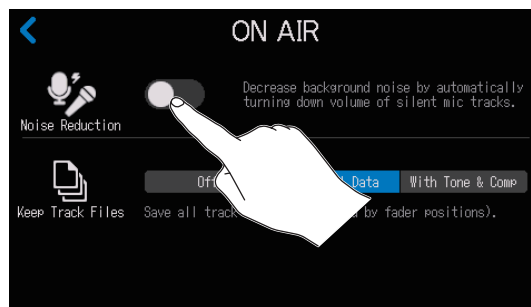

Setting recording file types

The types of files recorded to the SD card can be set.

The options include recording only a stereo mix of all the inputs or also simultaneously recording separate files for each channel (mic, USB and smartphone inputs, and SOUND PAD sounds).

Various editing functions can be used on separate files after recording by transferring them to a computer or other device. For example, their mix balance can be adjusted, effects can be added, and lengths can be changed.

1. Tap **ON AIR** on the Home Screen.
2. Tap the recording file type setting.

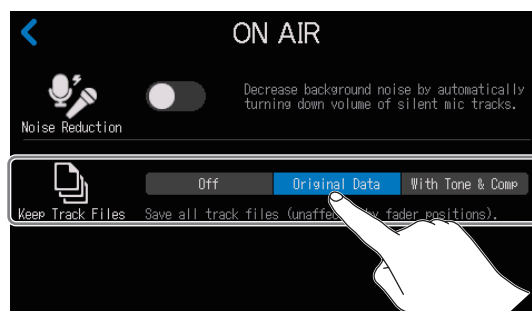

Setting	Explanation
Off	Only record stereo files for podcasting.
Original Data	In addition to stereo files for podcasting, individual files are also recorded for each channel. The individual files for each channel are recorded before being affected by the fader, Tone, Comp/DeEss and other adjustments.
With Tone & Comp	In addition to stereo files for podcasting, individual files are also recorded for each channel. The individual files for each channel are recorded before faders, but after being affected by the Tone, Comp/DeEss and other adjustments.

NOTE

See the mixer block diagram for how effects are applied to individual channel recording files for different settings. (→ [“Mixer block diagram” on page 93](#))

Testing SD cards

SD cards can be tested to confirm whether they can be used with the **P8**.

A quick test can be done in a short amount of time, while a full test examines the entire SD card.

Conducting a quick test

1. Tap  on the Home Screen.

2. Tap .

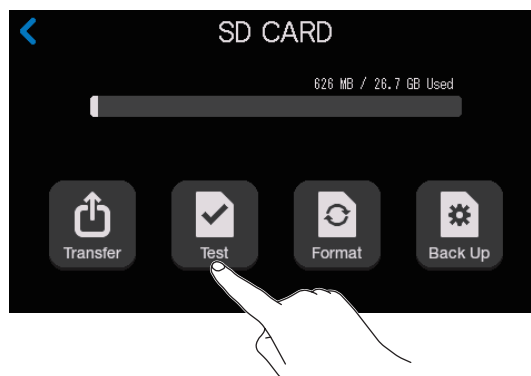

3. Tap **QuickTest**, and then tap **Execute**.

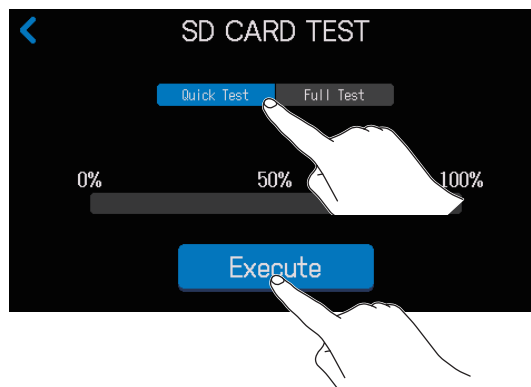

The card performance test will start. The test should take about 30 seconds.

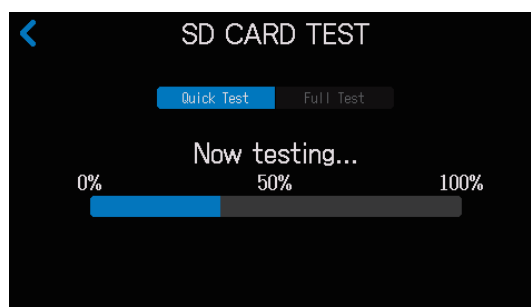

The result of the test will be shown when it completes.

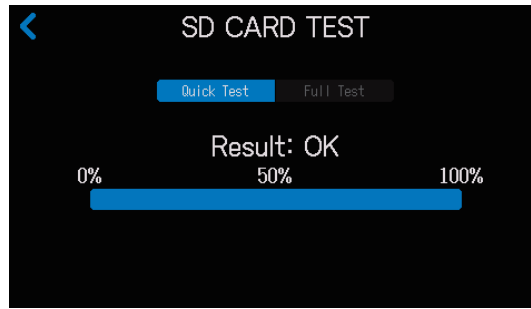



NOTE

Even if a performance test result is "OK", there is no guarantee that writing errors will not occur. This information is just to provide guidance.

HINT

Tap  to cancel a test while it is being executed.

Conducting a full test

1. Tap  on the Home Screen.
2. Tap .

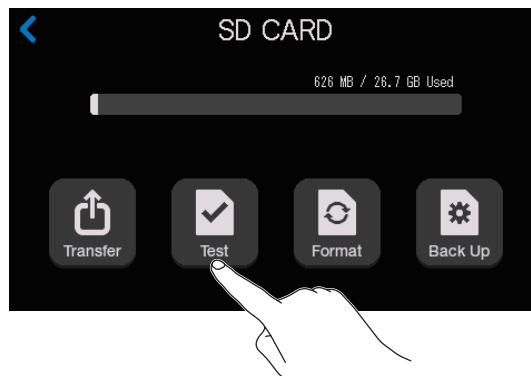

3. Tap **Full Test**, and then tap **Execute**.

The approximate amount of time required for the test will be shown.

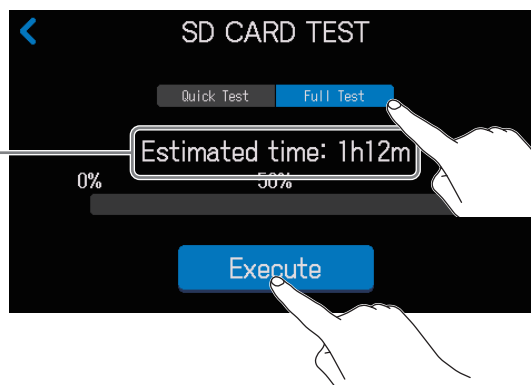

The card performance test will start.

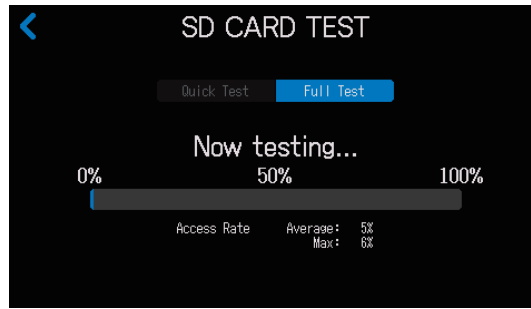

The result of the test will be shown when it completes.

If the Access Rate Max reaches 100%, the card will fail (NG).

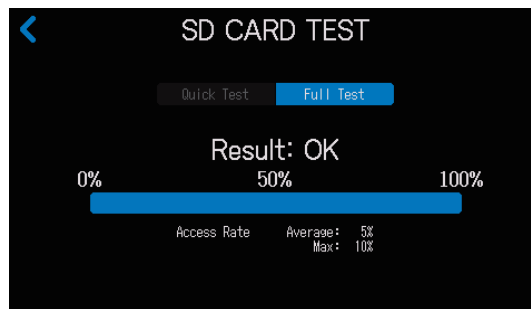

NOTE

Even if a performance test result is "OK", there is no guarantee that writing errors will not occur. This information is just to provide guidance.

HINT

Tap  to cancel a test while it is being executed.

Formatting SD cards

Format SD cards for the **P8** to maximize their performance.

Before using SD cards that have just been purchased or that have been formatted on a computer, they must be formatted by the **P8**. Be aware that formatting an SD card will delete all data, including files assigned to SOUND PAD buttons, on it.

1. Tap  on the Home Screen.

2. Tap .

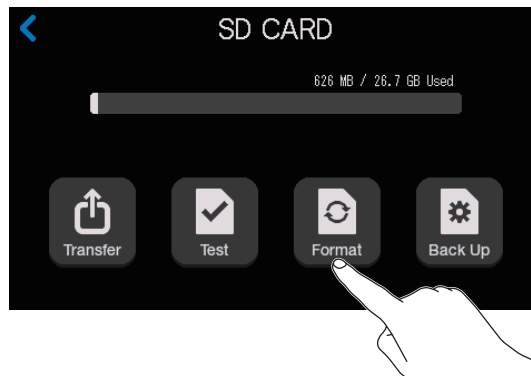

3. Tap **Format**.

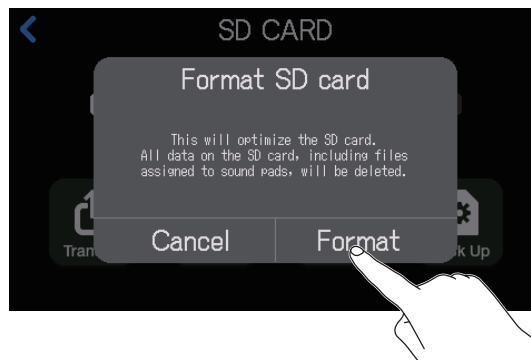

This formats the card.

Select **Cancel** to cancel formatting.

Using SD cards to back up and load settings

Settings related to the inputs and outputs of each channel, SOUND PAD functions, recording and power can be backed up on SD cards. Backing up frequently used settings can be useful.

Backing up

1. Tap  on the Home Screen.

2. Tap .

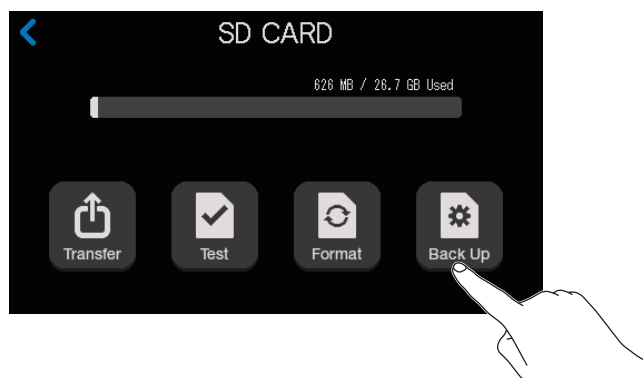

3. Tap **Save to SD card**.

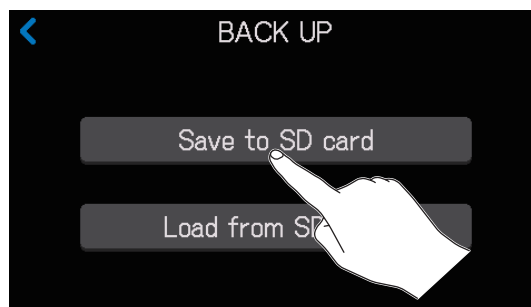

If a backup file already exists on the SD card, tap **Save**.



Tap **Cancel** to cancel backing up.

4. Tap **Close**.

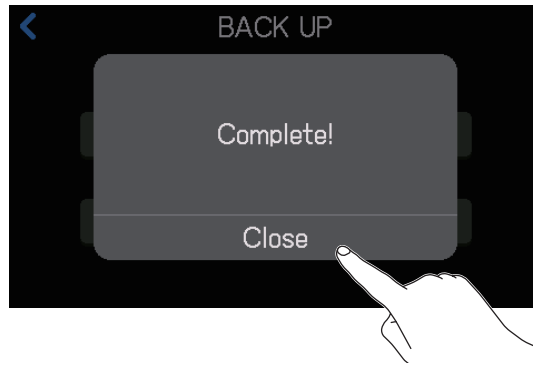

The current settings are now backed up on the SD card

NOTE

- Only one set of settings can be backed up to an SD card. If a backup file already exists on a SD card, it will be overwritten and the old settings will be deleted.
- The following items will not be backed up.
Channel fader positions, PHONES, USB OUT and SPEAKER OUT knob positions, **DATE & TIME**, **LANGUAGE** and **Tablet Mode** settings, and **SOUND PAD** file assignments

Loading backup settings

1. Tap  on the Home Screen.

2. Tap .

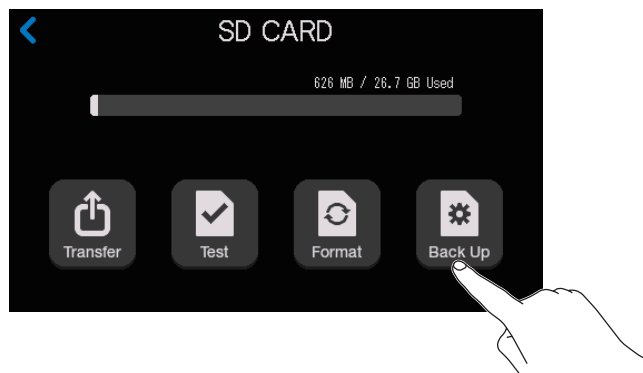

3. Tap **Load from SD card**.

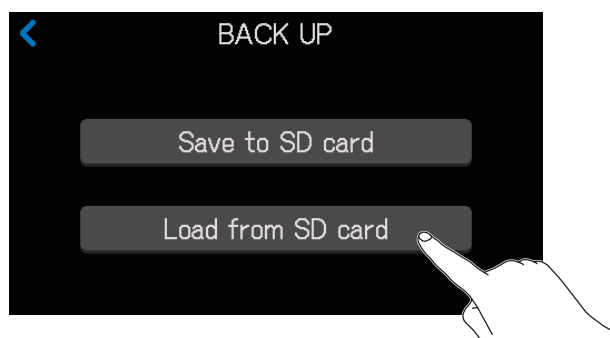

4. Tap Load.



Tap **Cancel** to cancel loading backup settings.

NOTE

Loading gain settings could cause sudden output of loud sounds. Always lower the faders and knobs before loading settings.

Setting the automatic power off function

When running on power from an AC adapter, the **P8** will automatically turn off if it is unused for 10 hours. To keep the power on at all times, turn off the AUTO POWER OFF function.

1. While pressing , set  to ON.

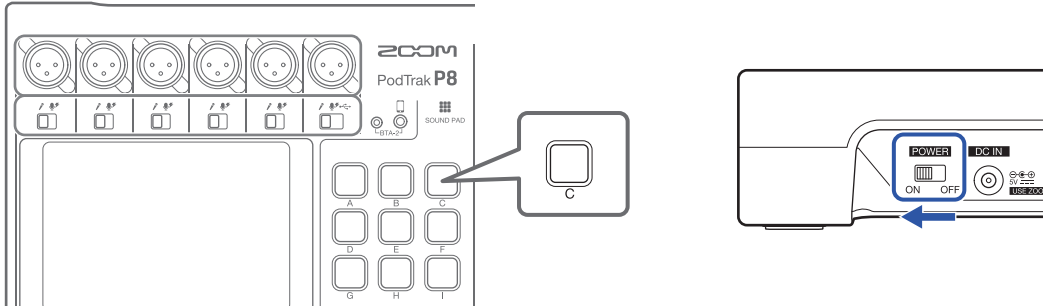

2. Tap the ON/OFF button to change the setting.

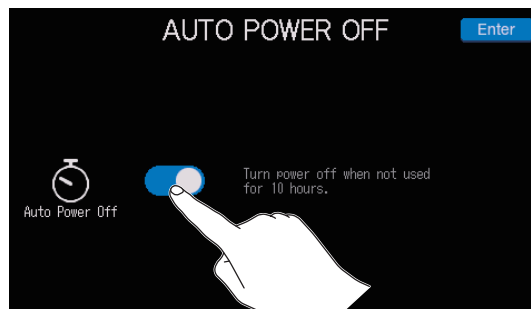

Setting	Explanation
ON	The power will automatically turn off if it is not used for 10 hours.
OFF	The power will not turn off automatically.

3. Tap .

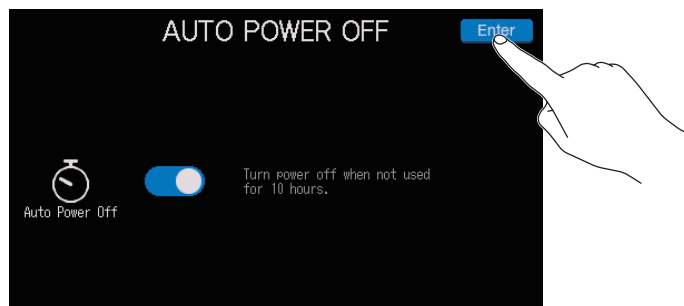

This opens the Home Screen.

Restoring factory default settings

The **P8** can be restored to its factory default settings.

1. While pressing , set  to ON.

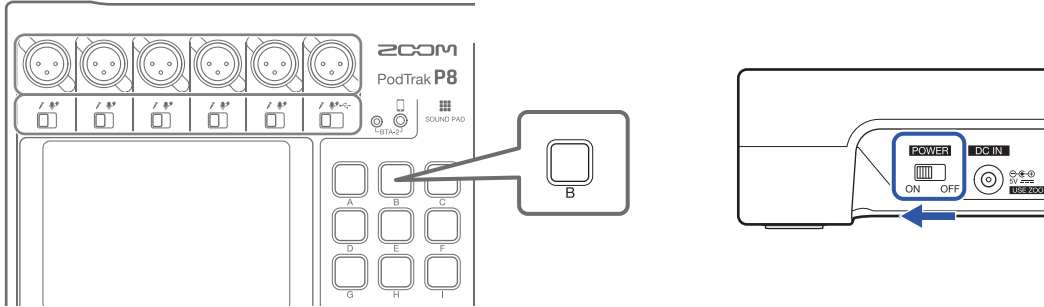

2. Tap **Reset**.

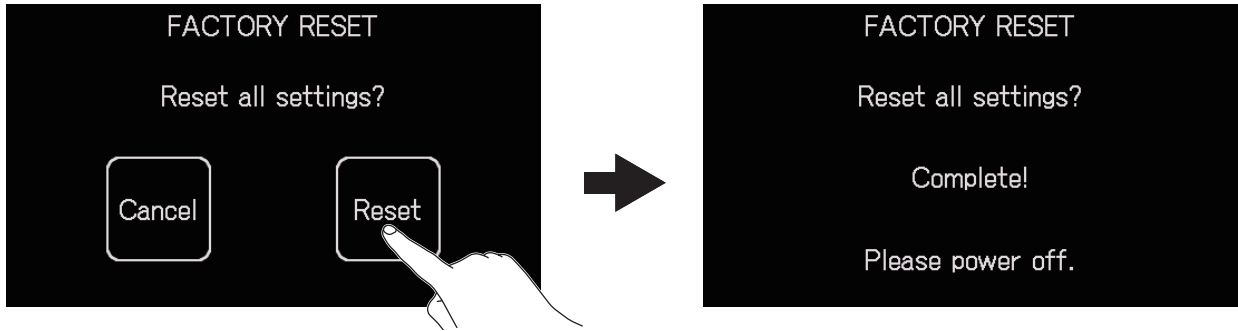

Tap **Cancel** to cancel resetting and open the Home Screen on the touchscreen.

3. Set  to OFF.

This resets the **P8** to its factory default settings. After "Goodbye See You!" appears on the touchscreen, the power turns off.

NOTE

- A factory reset will overwrite all settings to their factory defaults. Be certain before using this function.
- Make initial settings the first time the power is turned on after the **P8** has been restored to its factory default state. (→ ["Making initial settings" on page 22](#))

Updating the firmware

The **P8** firmware can be updated to the latest versions.



Download files for the latest firmware update from the ZOOM website (zoomcorp.com).

Follow the instructions in the “P8 Firmware Update Guide” on the **P8** download page.

Troubleshooting

General

There is no sound or output is very quiet

- Check headphone connections and volumes. (→ [“Connecting headphones” on page 25](#))
- Check mic connections. (→ [“Connecting mics” on page 24](#))
- When using condenser mics, set the INPUT SELECT switches to . (→ [“Connecting mics” on page 24](#))
- Confirm that  is unlit.
- Raise the faders for each channel to raise their levels, and confirm that their level meters are moving. (→ [“Balancing the mix of channel levels” on page 35](#))
- Turn  for the output being used to adjust the output level. (→ [“Connecting” on page 24](#))

Recorded audio is too loud, too quiet or silent

- When using condenser mics, set the INPUT SELECT switches to . (→ [“Connecting mics” on page 24](#))
- Use the channel faders to raise the levels. (→ [“Balancing the mix of channel levels” on page 35](#))
- Confirm that the REC indicators are lit red.

Recording is not possible

- Confirm that the REC indicators are lit red.
- Confirm that the SD card has open space.

Proper recording is not possible/Stopping recording takes too much time

- SD cards can become worn out. Speed can decrease after repeated writing and erasing.
- Formatting the card with the **P8** might improve this. (→ [“Formatting SD cards” on page 83](#))
- If formatting an SD card does not improve this, we recommend replacing the card. Please check the list of cards that have been confirmed to work on the ZOOM website.

NOTE

This is not a guarantee of specific SD card recording performance for SDHC/SDXC cards that have been confirmed to work. This list is provided as a guideline to help find suitable cards.

Playback sound cannot be heard or is quiet

- Turn the PHONES knobs to adjust their volumes. (→ [“Connecting headphones” on page 25](#))
- Turn the SPEAKER OUT knob to adjust its volume. (→ [“Connecting powered speakers and other output equipment” on page 31](#))

Audio files cannot be assigned to SOUND PAD buttons

- Check the format of the audio file to be assigned. (→ [“Assigning audio files to SOUND PAD buttons” on page 43](#))
- If the audio file is stored on an SD card, store it in a directory outside the P8_Multitrack and P8_Settings folders on the card.

SOUND PAD functions cannot be used

- Check the SOUND PAD levels. (→ [“Playing SOUND PAD buttons” on page 42](#))
- Confirm that files are assigned. (→ [“Assigning audio files to SOUND PAD buttons” on page 43](#))

Audio interface

Cannot select the P8 from a computer, smartphone or tablet (or cannot use it as an interface)

- Confirm that the **P8** is connected to the computer correctly. (→ [“Connecting a computer, smartphone or tablet by USB” on page 28](#))
- Quit all the software that is connected to the **P8**, and turn the **P8** off and on again.
- Connect the **P8** directly to a USB port on the computer or other device. Do not connect it through a USB hub.

Sound skips during playback or recording

- If the audio buffer size of the software being used can be adjusted, increase the buffer size.
- Connect the **P8** directly to a USB port on the computer or other device. Do not connect it through a USB hub.
- Turn off power saving settings (including sleep functions) on the computer or other device.

Cannot play or record

- Confirm that the **P8** is connected to the computer correctly. (→ [“Connecting a computer, smartphone or tablet by USB” on page 28](#))
- Confirm that the **P8** is selected in the settings of the computer being used.
- Confirm that **P8** is set for input and output in the software being used.
- Set INPUT SELECT switch 6 to .
- Quit all the software that is connected to the **P8**, and disconnect and reconnect the USB cable connected to the **P8**.

Specifications

Input and output channels	Number of input channels		Mic inputs: 6 (mono) Smartphone input: 1 (stereo)
	Number of output channels		2 (through 6 headphone and L/R speaker outputs)
Connectors	Mic	Type	XLR jacks (2: HOT)
		Input gain	0 – +70 dB
		Input impedance	3 k Ω
		Maximum input level	+5 dBu (at 0 dBFS)
		Phantom power	+48 V
	Smartphone connection jack	Type	TRRS mini jack (4-contact/TIP: L, RING 1: R, RING 2: GND, SLEEVE: MIC)
		Input impedance	3 k Ω
		Maximum input level	+2.5 dBu
	USB		USB Type-C (audio interface and mass storage functions) • Use a USB cable that supports data transfer. USB bus power is supported.
	Headphones	Type	3.5 mm stereo mini
		Maximum output level	20 mW + 20 mW (32 Ω load)
		Output impedance	27 Ω
Speaker outputs	Type	TRS jacks (balanced)	
	Maximum output level	+5.5 dBu	
	Output impedance	320 Ω	
AC adapter		Power supply connector for AD-14	
Recorder	Format	WAV 44.1kHz, 16-bit, mono/stereo	
	Recording media	4–32GB cards compatible with the SDHC specification (class 10 or higher) 64–512GB cards compatible with the SDXC specification (class 10 or higher)	
Audio interface		44.1kHz, 16-bit, 2-in/2-out	
Frequency response		–1.0 dB: 20 Hz – 20 kHz at 44.1kHz sampling rate	
Equivalent input noise		–124 dBu or less (IHF-A) at +70dB/150 Ω input	
Display		4.3" (480x272) full-color touchscreen LCD	
Power		4 AA batteries (alkaline, lithium, or rechargeable NiMH) AC adapter (ZOOM AD-14): DC 5 V/1 A (supports USB bus power)	
Estimated continuous operation time using batteries		Recording 44.1kHz/16-bit/4ch audio to SD card (when +48 V is OFF and headphone impedance is 32 Ω) Alkaline batteries: about 1.5 hours NiMH batteries (1900 mAh): about 3 hours Lithium batteries: about 5 hours •The above values are approximate. • Continuous battery operation times were determined using in-house testing methods. They will vary greatly according to use conditions.	
Power consumption		5 W	
External dimensions		295 mm (W) x 248 mm (D) x 61 mm (H)	
Weight (unit only)		1.43 kg	

• 0 dBu = 0.775 V

Mixer block diagram

P8 MIXER BLOCK DIAGRAM

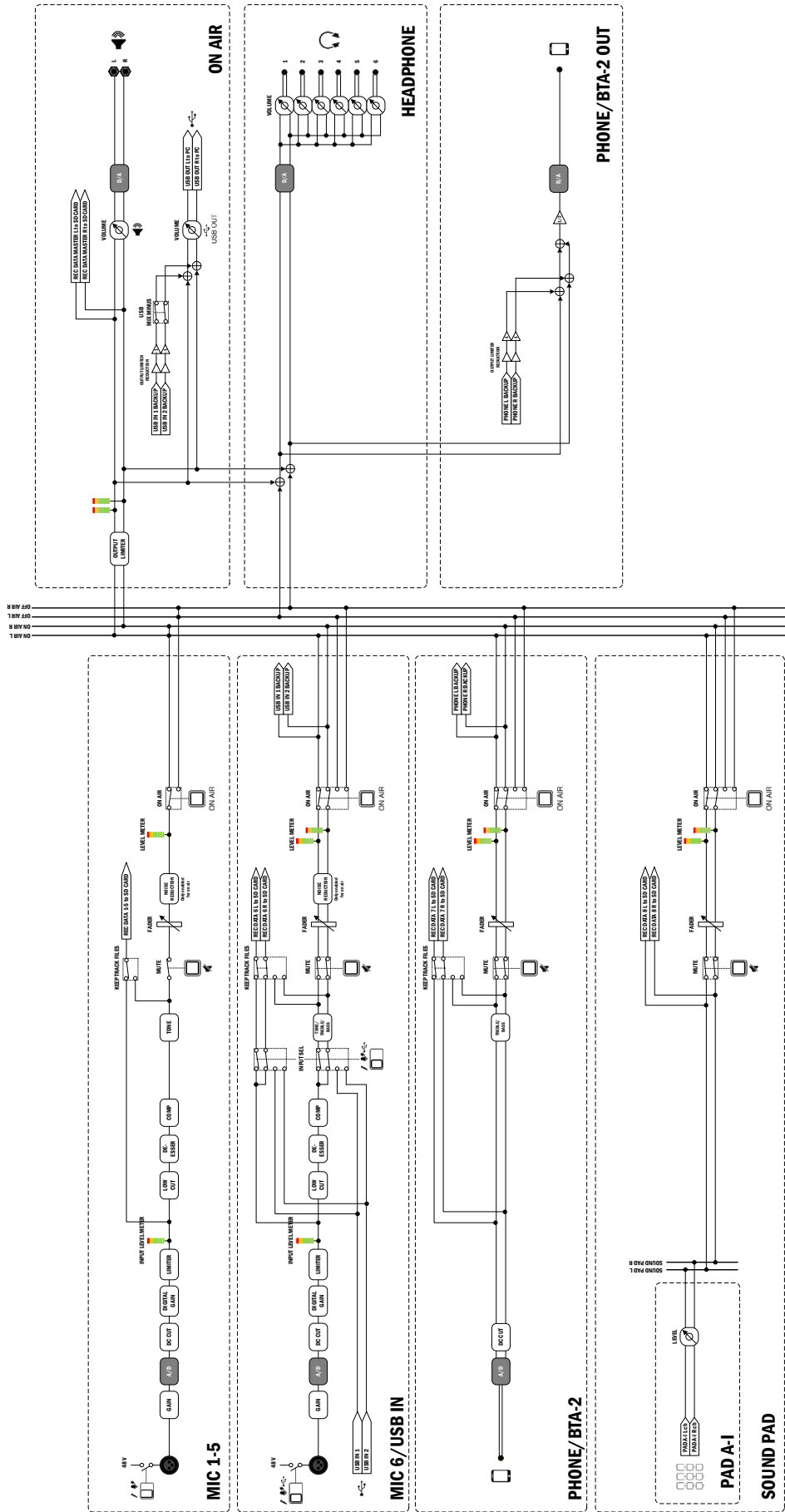



ZOOM CORPORATION

4-4-3 Kanda-surugadai, Chiyoda-ku, Tokyo 101-0062 Japan
zoomcorp.com